

Stratos Pro A201N-CC

Dual Conductivity Measurement

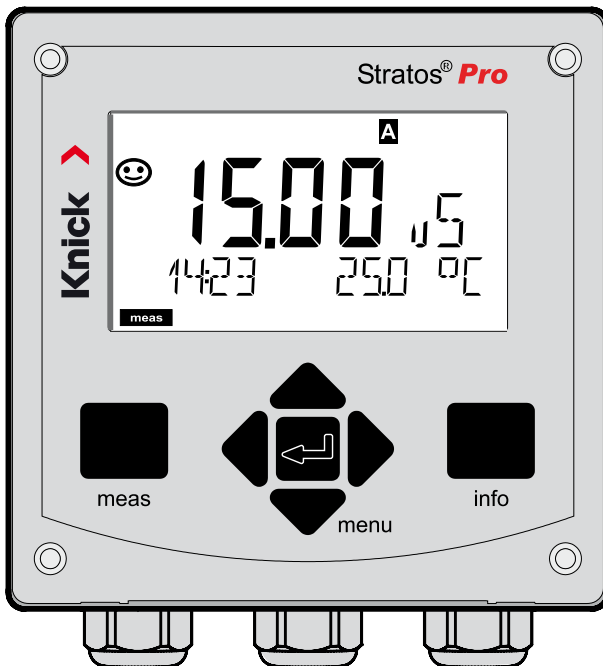

Read before installation.
Keep for future use.



Supplemental Directives

Read this document and retain it for future reference. Before assembling, installing, operating, or maintaining the product, ensure that you fully understand the instructions and risks. Observe all safety instructions. Failure to follow the instructions in this document may result in serious injury and/or property damage.

This document is subject to change without notice.

These supplemental directives explain how safety information is laid out in this document and what content it covers.

Safety Chapter



This document's Safety chapter is designed to give the reader a basic understanding of safety. It illustrates general hazards and gives strategies on how to avoid them.

Safety Guide

The external Safety Guide is designed to give the reader a basic understanding of safety. It illustrates general hazards and suggests strategies on how to avoid them.

Warnings

This document uses the following warnings to indicate hazardous situations:

Symbol	Category	Meaning	Remark
	WARNING	Designates a situation that can lead to death or serious (irreversible) injury.	The warnings contain information on how to avoid the hazard.
	CAUTION	Designates a situation that can lead to slight or moderate (reversible) injury.	
None	NOTICE	Designates a situation that can lead to property or environmental damage.	

Additional Safety Information

Stratos Safety Guide

Safety Guide

In official EU languages and others

Quickstart Guides

Installation and first steps:

- Operation
- Menu structure
- Calibration
- Error messages and recommended actions

Test Report 2.2 According to EN 10204

Electronic Documentation

www.knick-international.com:

Manuals + software

Table of Contents

Supplemental Directives.....	2
Documents Supplied	3
Safety	6
Always Read and Observe the Safety Instructions!.....	6
Intended Use	6
Introduction	8
Overview of Stratos Pro A201N-CC.....	10
Assembly.....	11
Package Contents	11
Electrical Installation	15
Rating Plates / Terminal Assignments.....	16
Wiring of Stratos Pro A201N-CC	17
Wiring Examples.....	18
User Interface, Keypad	21
Display	22
Signal Colors (Display Backlighting)	22
Measuring Mode.....	23
Selecting the Mode / Entering Values	24
Color-Coded User Interface	26
Operating Modes.....	27
HOLD Mode	29
Alarm	30
Alarm and HOLD Messages.....	31
Configuration	32
Menu Structure of Configuration.....	32
Setup and Channel Selection on the Device	33
Calculations (CALC)	34
Calculating the pH Value by Means of Dual Conductivity Measurement	36

Configuration (Template for Copy)	42
Configuring Sensors A, B.....	44
Current Output 1	48
Current Output 2.....	56
CONTROL Input (TAN SW-A005)	58
Alarm Settings.....	60
Time and Date.....	62
Measuring Point (TAG)	64
Display Backlighting	64
Calibration	66
Calibration by Input of Cell Factor.....	67
Measurement	68
Diagnostics	69
Service	74
Operating States	77
Supply Units and Connection	78
Product Line and Accessories	79
Specifications	80
Error Handling	84
Error Messages	85
Decommissioning	87
Disposal	87
Returns.....	87
Sensocheck and Sensoface	88
HART: Typical Applications	90
FDA 21 CFR Part 11	91
Electronic Signature – Passcodes.....	91
Audit Trail.....	91
Index	92

Safety

Always Read and Observe the Safety Instructions!

The device is constructed in accordance with the latest technology and generally accepted safety rules and regulations.

Under certain circumstances, however, usage may pose risks to users or cause damage to the device.

Commissioning must be carried out by specialist personnel authorized by the operating company. If safe operation is not possible, the device must not be switched on or, if it is already on, must be switched off properly and secured against unintended operation.

Reasons to assume safe operation is not possible:

- the device shows visible damage
- failure to perform the intended function
- prolonged storage at temperature of below -30 °C/-22 °F or above 70 °C/158 °F
- severe transport stresses

Before recommissioning the device, a professional routine test must be performed. This test should be carried out by the manufacturer at its factory.

Intended Use

Stratos Pro A201N-CC is a 2-wire device for two-channel measurement of electrical conductivity and temperature in liquids. The device has been designed for measurements before and after cation exchangers using commercial analog 2-electrode sensors. Different parameters can be calculated from the two conductivity values, e.g. difference, ratio, rejection, but also the pH value of feed water.

The defined rated operating conditions must be observed when using this product. They can be found in the Specifications chapter of this User Manual; see page 80.

Function Check Mode (HOLD Function)

After activating configuration, calibration, or service, Stratos Pro enters function check mode (HOLD).

The current outputs respond in accordance with the configuration.

Operations must not be carried out while Stratos Pro is in function check (HOLD) mode, as the system may behave unexpectedly and put users at risk.

Devices Not Intended for Use in Hazardous Locations

Devices identified with an N in their product name must not be used in hazardous locations.

Configuration

Replacing components may affect intrinsic safety. The modules are not intended to be replaced on devices in the Stratos Pro A201 product line.

Introduction

Housing and Mounting Options

- The sturdy molded enclosure is designed for IP66/IP67 / TYPE 4X Outdoor protection, is made of PBT glass fiber reinforced PC, and has the following dimensions: H 148 mm, W 148 mm, T 117 mm. Knockouts in the housing enable
 - wall mounting (with sealing plugs to seal the housing)
see page 12
 - pipe mounting (Ø 40 ... 60 mm, □ 30 ... 45 mm)
see page 13
 - panel mounting (cutout 138 mm x 138 mm acc. to DIN 43700)
see page 14

Protective Hood (Accessory)

The protective hood, which is available as accessory, provides additional protection against direct weather exposure and mechanical damage; see page 13.

Connection of Sensors, Cable Glands

For connecting the cables, the enclosure provides

- 3 knockouts for M20x1.5 cable glands
- 2 knockouts for ½" conduit

Display

Plain-text messages on a large, backlit LC display enable intuitive operation. You can specify which values are to be displayed in standard measuring mode ("Main Display," see page 25).

Color-Coded User Interface

The colored display backlighting indicates different operating states (e.g., alarm: red, HOLD mode: orange; see page 26). The display backlighting can be switched off; see page 64.

Diagnostic Functions

“Sensocheck” automatically monitors sensor and cables; and the “Sensoface” function clearly indicates the sensor condition; see page 88.

Data Logger

The internal logbook (TAN SW-A002) can handle up to 100 entries – up to 200 with AuditTrail (TAN SW-A003); see page 72.

Password Protection

Password protection (passcodes) for granting access rights during operation can be configured; see page 76.

TC Process Medium: Selecting the Compensation Method

The following temperature compensation methods are provided: linear (by entering a temperature coefficient), natural waters (nLF), ultrapure water with traces of NaCl, HCl, NH₃, NaOH, see page 44.

Control Inputs (TAN SW-A005)

The floating, digital control input “HOLD” allows remote controlled switching to HOLD mode. The “CONTROL” input allows evaluation of external monitoring equipment, such as a flow monitoring system. For that purpose, you can also monitor the current input for keeping a desired value.

Signal Outputs

The device provides two current outputs (for transmission of measured value and temperature, for example). The output curve is adjustable (linear or bilinear), see page 48.

Options

Additional functions can be enabled by entering a TAN (p. 76).

Overview

Overview of Stratos Pro A201N-CC

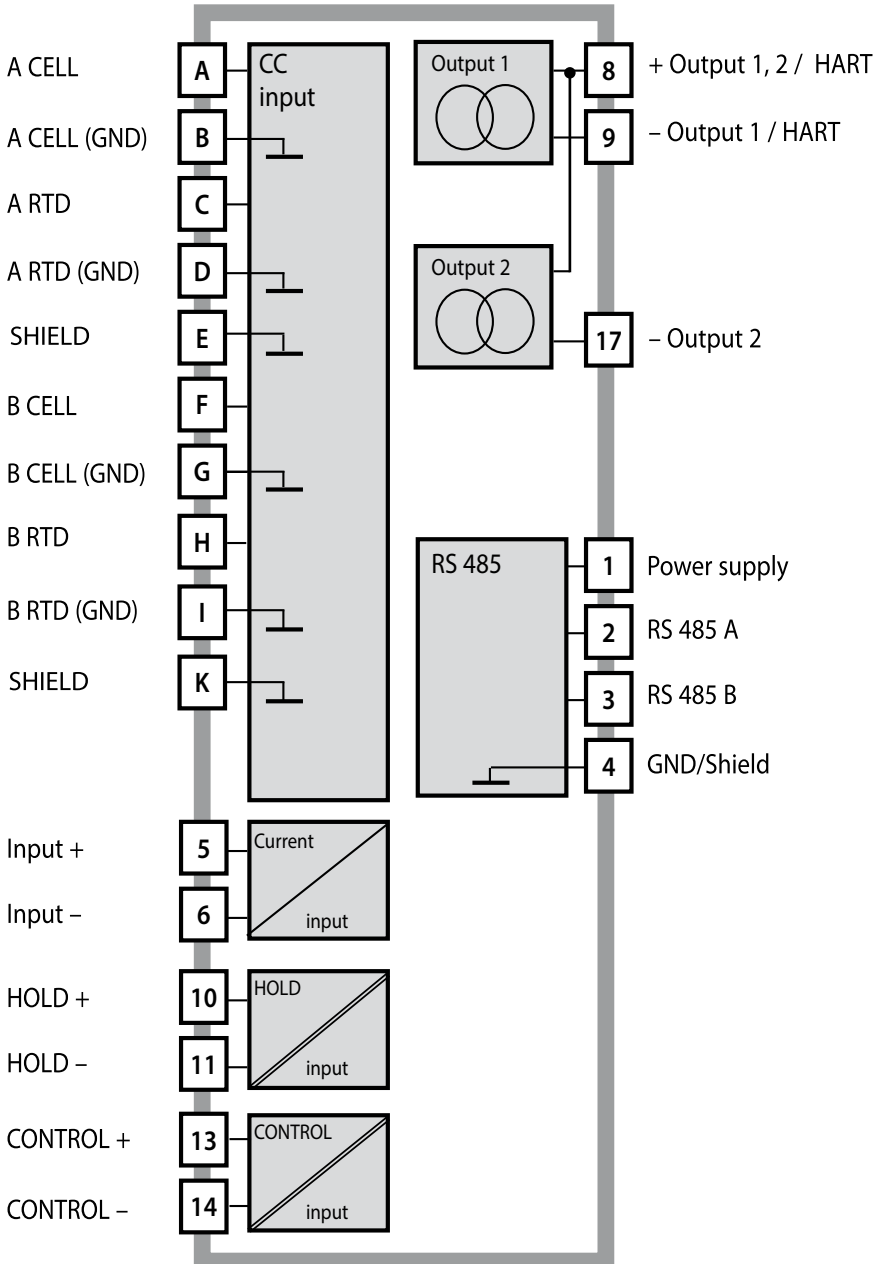

Package Contents

Note: Check all components for damage upon receipt.
Do not use damaged parts.

The package should contain:

- Front unit, rear unit, bag containing small parts
- Specific test report
- Documentation (see page 3)

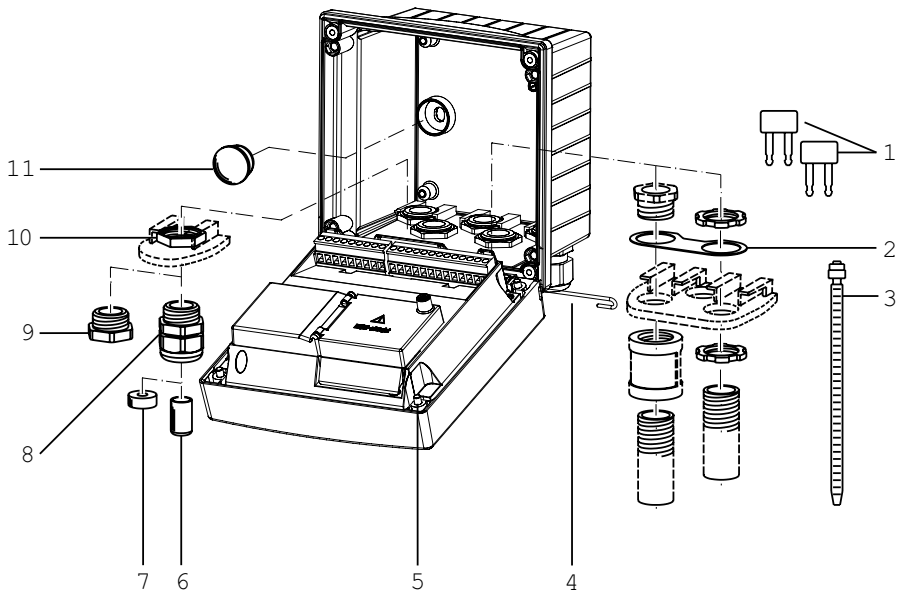

Fig.: Assembling the enclosure

- | | |
|--|---|
| 1) Insertable jumper (3x) | 6) Blanking plug (2x, non-Ex only) |
| 2) Plate (1x), for conduit mounting: Plate between housing and nut | 7) Reduction sealing insert (1x) |
| 3) Cable tie (3x) | 8) Cable gland (3x) |
| 4) Hinge pin (1x), insertable from either side | 9) Blanking cap (2x) |
| 5) Enclosure screw (4x) | 10) Hex nut (5x) |
| | 11) Plastic sealing plug (2x), for sealing in case of wall mounting |

Mounting Plan, Dimensions

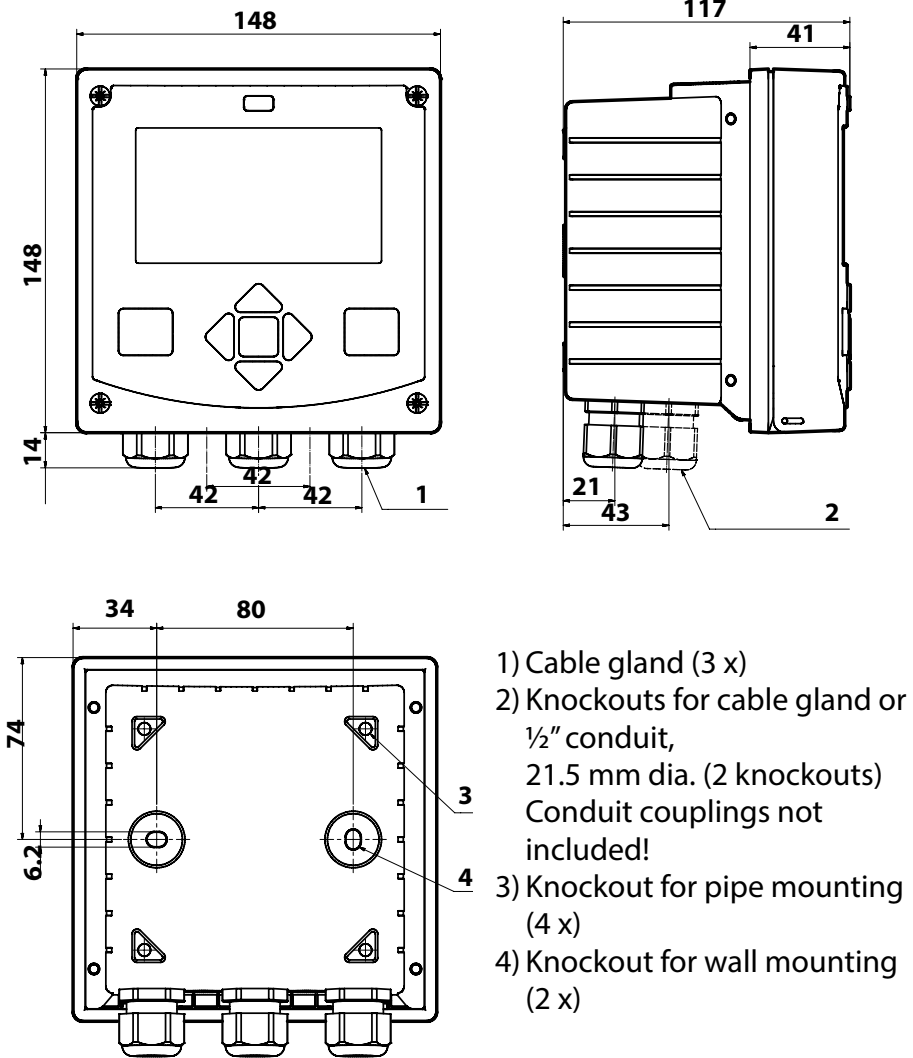
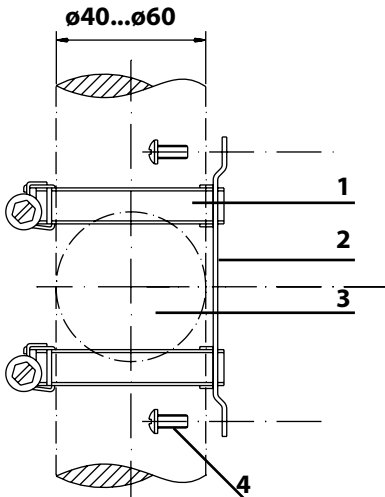

Fig.: Mounting plan (All dimensions in mm!)

Pipe Mounting, Protective Hood



- 1) Hose clamp with worm gear drive to DIN 3017 (2 x)
- 2) Pipe-mount plate (1 x)
- 3) For vertical or horizontal posts or pipes
- 4) Self-tapping screw (4 x)

Fig.: Pipe-mount kit, accessory ZU 0274 (All dimensions in mm!)

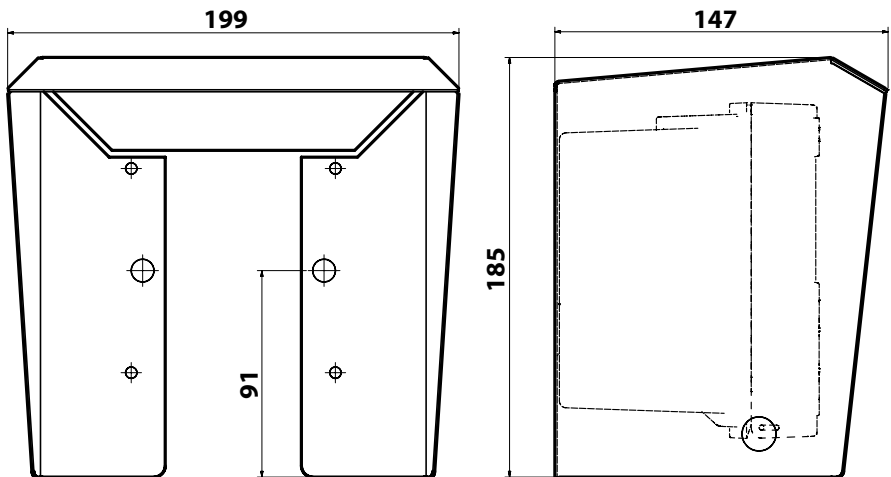
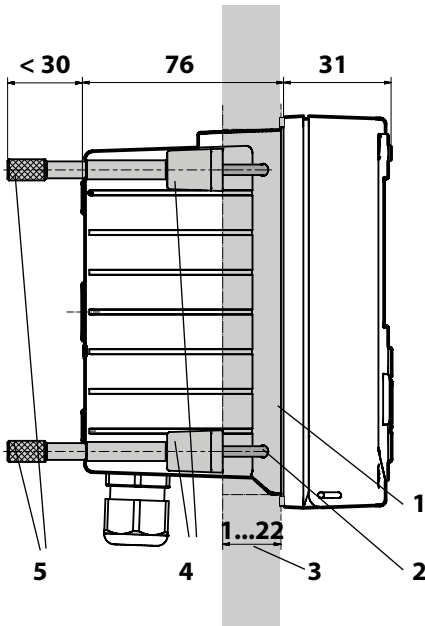

Fig.: Protective hood for wall and pipe mounting, accessory ZU 0737 (All dimensions in mm!)

Panel Mounting



- 1) Circumferential sealing (1 x)
- 2) Screws (4 x)
- 3) Position of control panel
- 4) Span piece (4 x)
- 5) Threaded sleeve (4 x)

Cutout

138 x 138 mm (DIN 43700)

Fig.: Panel-mount kit, accessory ZU 0738 (All dimensions in mm!)

Electrical Installation

Before commencing with the installation, make sure that all lines to be connected are de-energized.

Observe the safety instructions; see page 6.

Cable Glands

Cable glands	5 cable glands M20 x 1.5 A/F 24 mm
Clamping ranges	Standard sealing insert: 7 ... 13 mm
	Reduction sealing insert: 4 ... 8 mm
	Multiple sealing insert: 5.85 ... 6.5 mm
Tensile strain	Not permitted; Only suitable for "fixed installation"

⚠ CAUTION! Risk of losing the specified ingress protection. Fasten the cable glands and screw together the housing correctly. Observe the permissible cable diameters and tightening torques. Only use original accessories and spare parts.

NOTICE! Strip the insulation from the wires using a suitable tool to prevent damage. For stripping length, see Specifications.

- 1) Wire the current outputs. Deactivate unused current outputs in the parameter settings or use jumpers.
- 2) Wire the inputs as necessary.
- 3) Connect the sensor.
- 4) Check whether all connections are correctly wired.
- 5) Close the housing and successively tighten the enclosure screws in a diagonal pattern.

Rating Plates / Terminal Assignments

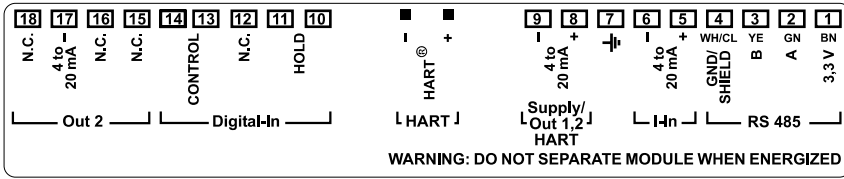

Fig.: Terminal assignments of Stratos Pro A201

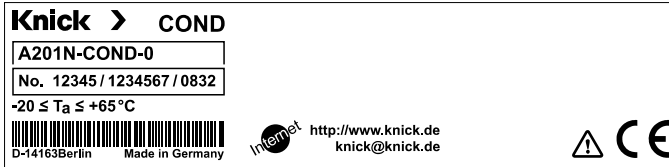
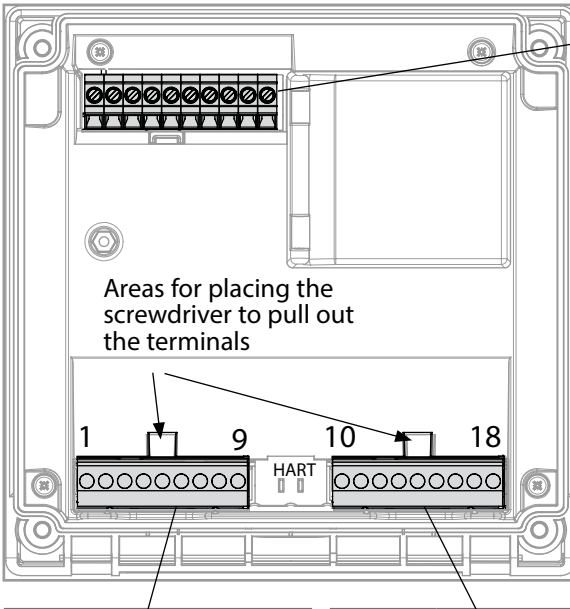

Fig.: Stratos Pro A201N rating plate at outside bottom of front (illustrative example)

Wiring of Stratos Pro A201N-CC



Sensor connection MK-CC module

A	A CELL
B	A CELL (GND)
C	A RTD
D	A RTD (GND)
E	SHIELD
F	B CELL
G	B CELL (GND)
H	B RTD
I	B RTD (GND)
K	SHIELD

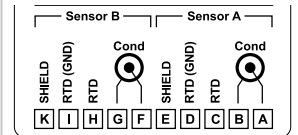

Fig.: MK-CC module terminal assignments

Terminal row 1

1	supply
2	RS 485 A
3	RS 485 B
4	GND/shield
5	+ input
6	- input
7	PA
8	+ out 1,2/HART
9	- out1/HART

Terminal row 2

10	hold
11	hold
12	n.c.
13	contr.
14	contr.
15	n.c.
16	n.c.
17	- out 2
18	n.c.

In addition:

2 HART pins (between terminal row 1 and 2)

Fig.: Terminals, device opened, back of front unit

Wiring Examples

Example 1:

Measuring task: Dual conductivity, temperature

Sensors (principle): 2 electrodes, coaxial

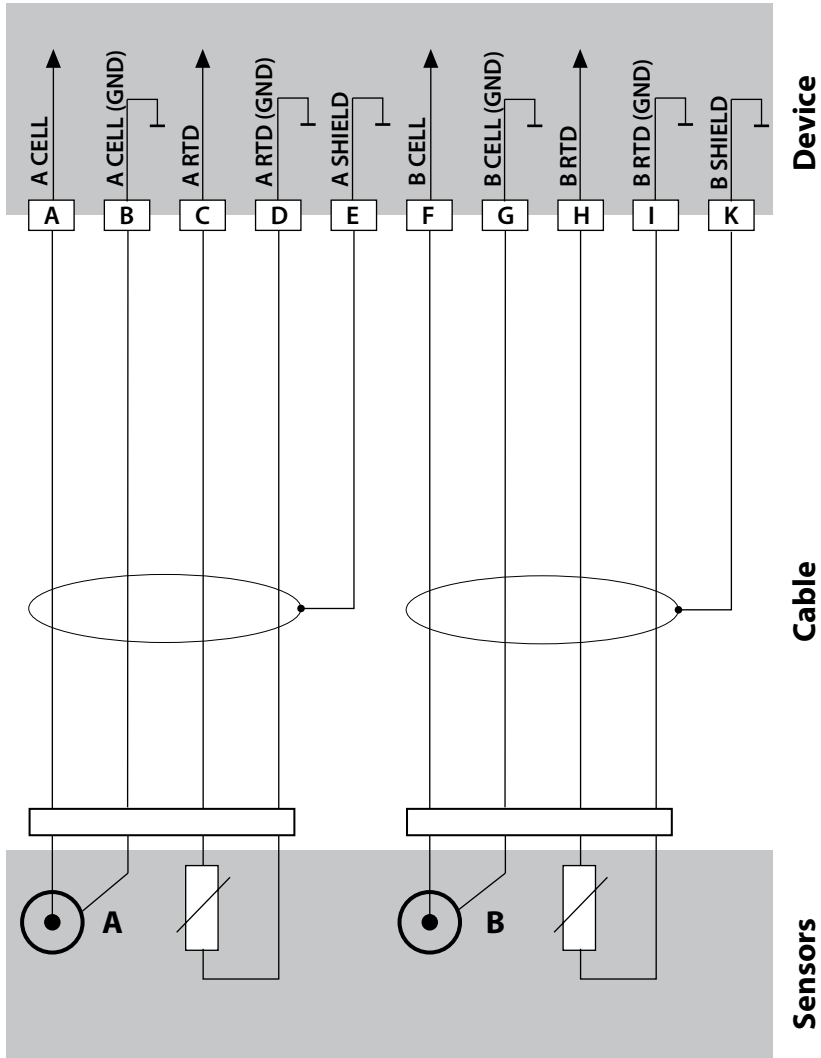

Example 2:

Measuring task:

Dual conductivity, temperature

Sensors:

SE604, 2 electrodes

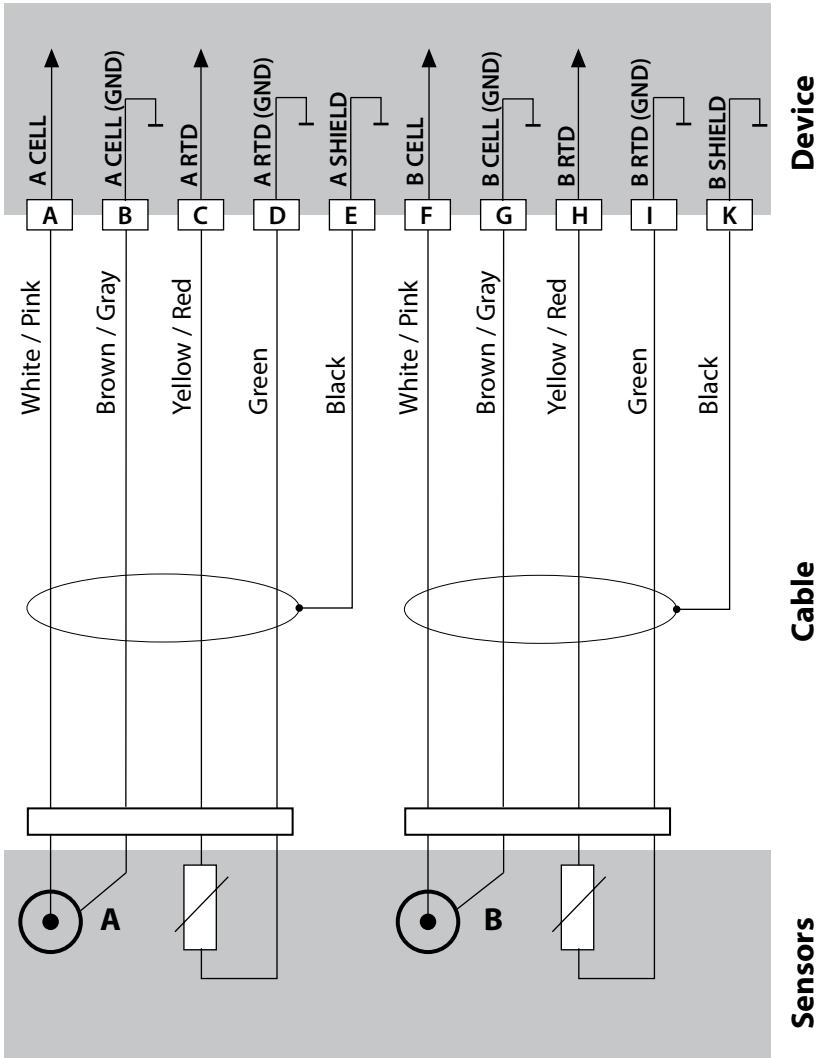

Wiring Examples

Example 3:

Measuring task:

Dual conductivity, temperature

Sensors:

SE610, 2 electrodes

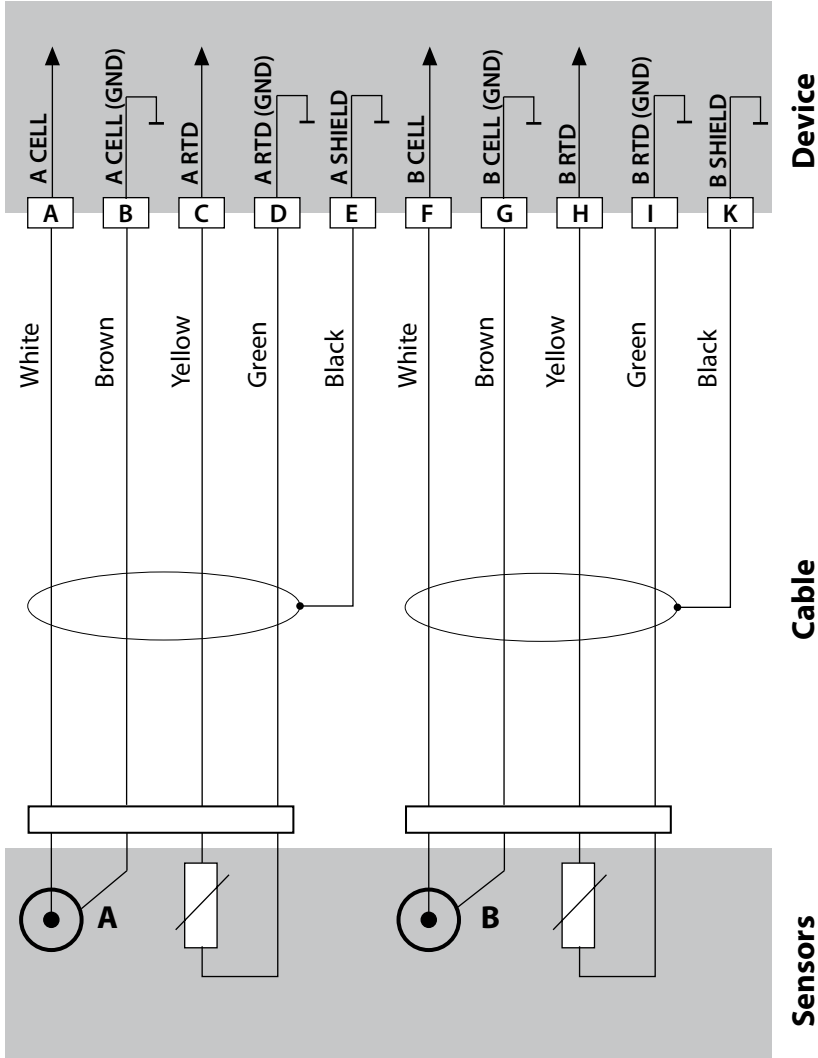

User Interface, Keypad

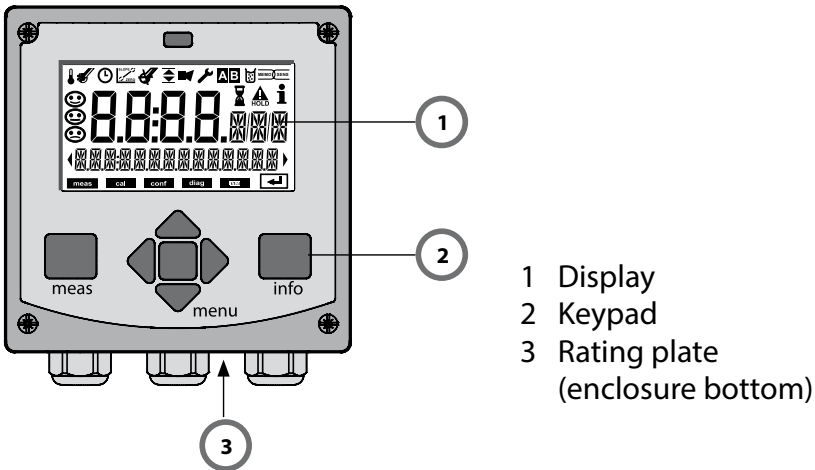

Key	Function
meas	<ul style="list-style-type: none">• Return to last menu level• Directly to measuring mode (press > 2 s)• Measuring mode: other display
info	<ul style="list-style-type: none">• Retrieve information• Show error messages
enter	<ul style="list-style-type: none">• Configuration: Confirm entries, next configuration step• Calibration: Continue program flow
menu	<ul style="list-style-type: none">• Measuring mode: Call menu
Arrow keys up / down	<ul style="list-style-type: none">• Menu: Increase/decrease a numeral• Menu: Selection
Arrow keys left / right	<ul style="list-style-type: none">• Previous/next menu group• Number entry: Move between digits

Display

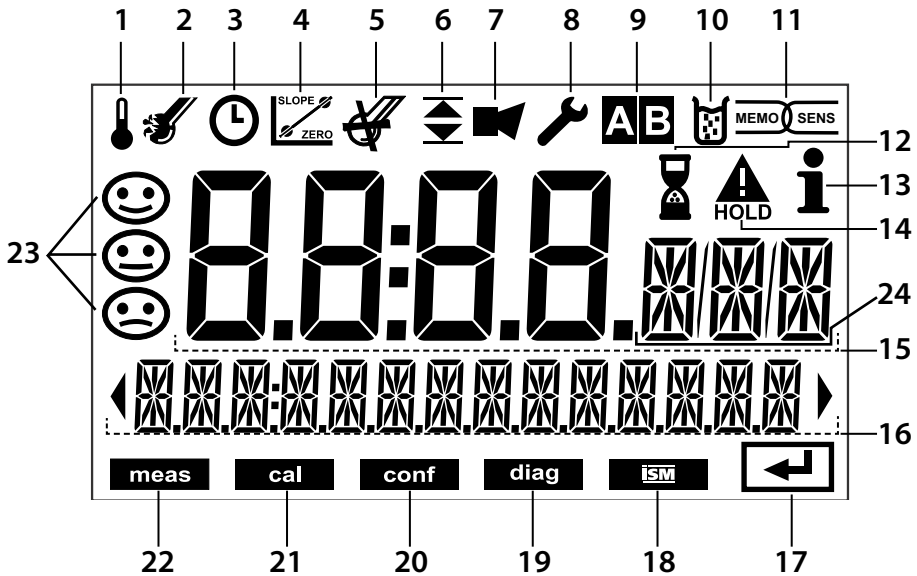

- | | | | |
|----|---------------------------------------|----|---------------------|
| 1 | Temperature | 13 | Info available |
| 2 | Sensocheck | 14 | Hold mode active |
| 3 | Interval/response time | 15 | Main display |
| 4 | Sensor data | 16 | Secondary display |
| 5 | Not used | 17 | Proceed using enter |
| 6 | Limit message:
Limit 1 or Limit 2 | 18 | Not used |
| 7 | Alarm | 19 | Diagnostics |
| 8 | Service | 20 | Configuration mode |
| 9 | Channel A / Channel B | 21 | Calibration mode |
| 10 | Calibration | 22 | Measuring mode |
| 11 | Not used | 23 | Sensoface |
| 12 | Waiting time running | 24 | Unit symbols |

Signal Colors (Display Backlighting)

- | | |
|--------------|---|
| Red | Alarm (in case of fault: display values blink) |
| Red blinking | Input error: illegal value or wrong passcode |
| Orange | HOLD mode (Calibration, Configuration, Service) |
| Turquoise | Diagnostics |
| Green | Info |
| Magenta | Sensoface message |

Measuring Mode

After the operating voltage has been connected and the sensor identified, the analyzer automatically goes to “Measuring” mode. To call the measuring mode from another operating mode (e.g. Diagnostics, Service): Hold **meas** key depressed (> 2 s).

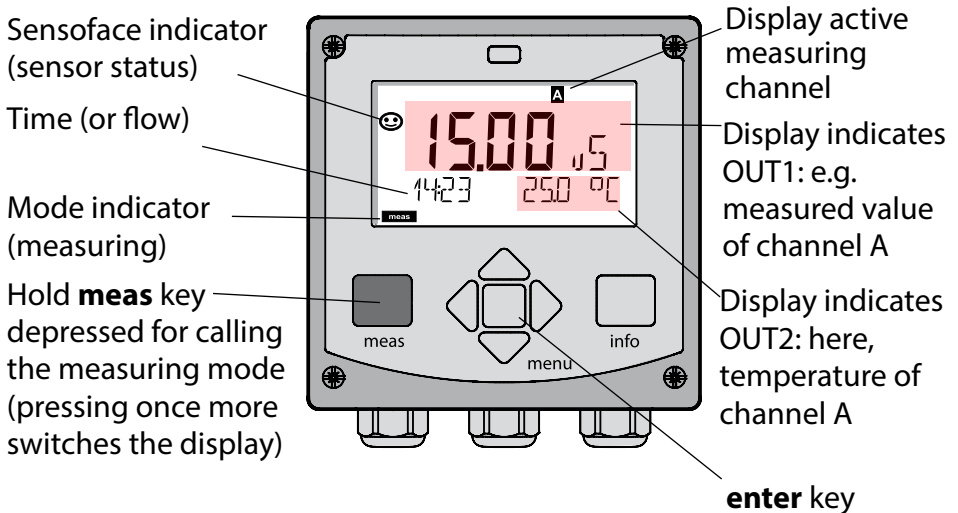

Depending on the configuration, one of the following displays can be set as standard display for the measuring mode (see page 24):

- Measured values channel A and channel B as well as time (default setting)
Measured value and measuring point (“TAG”)
- Conductivity and temperature of channel A (see example above)
- Conductivity and temperature of channel B
- Time and date
- Measured value channel A, channel B and flow
- Output currents

Note: By pressing the **meas** key in measuring mode you can view the displays for approx. 60 sec.



The analyzer must be configured for the respective measurement task, see page 32.

Selecting the Mode / Entering Values

To select the operating mode:

- 1) Hold **meas** key depressed (> 2 s) (directly to measuring mode)
- 2) Press **menu** key: the selection menu appears
- 3) Select operating mode using left / right arrow key
- 4) Press **enter** to confirm the selected mode

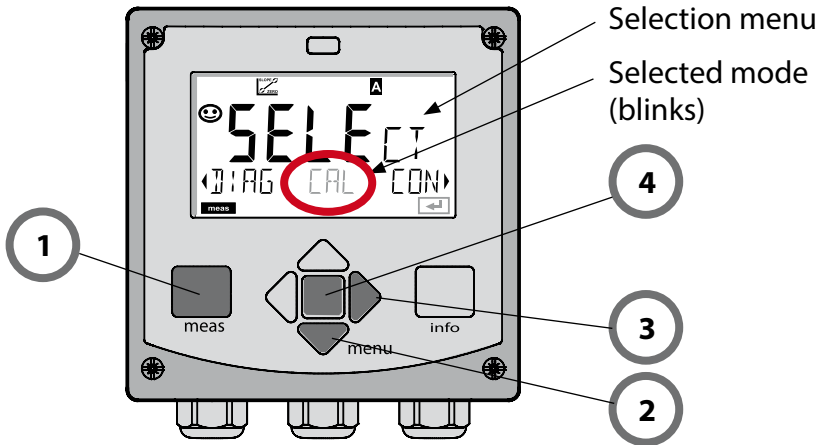

To enter a value:

- 5) Select numeral: left / right arrow key
- 6) Change numeral: up / down arrow key
- 7) Confirm entry by pressing **enter**

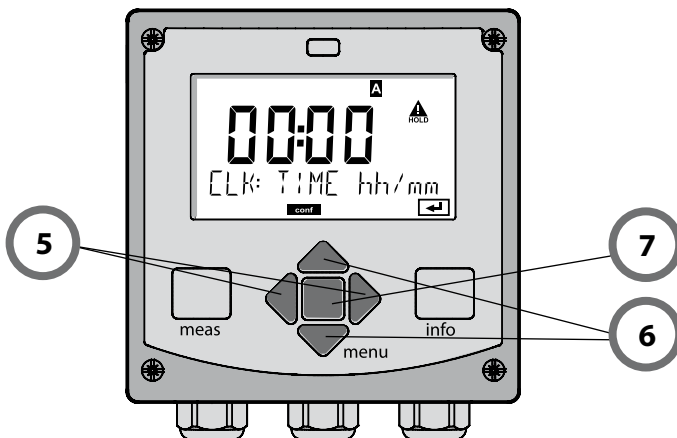

Display in Measuring Mode

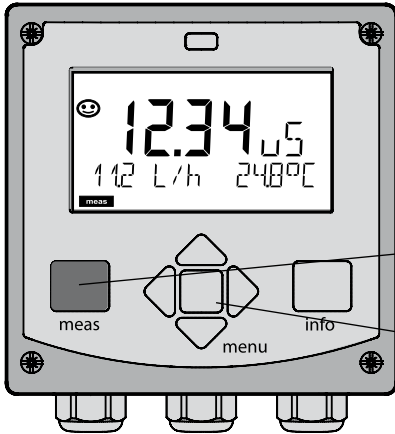

The MAIN DISPLAY is the display which is shown in measuring mode. To call the measuring mode from any other mode, hold the **meas** key depressed for at least 2 sec.

meas key

enter key

meas

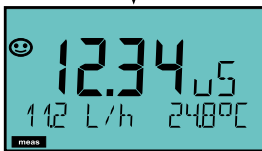

meas



enter

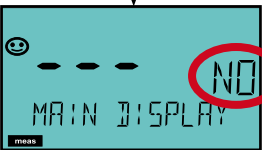

By pressing **meas** briefly you can step through further displays such as tag number (TAG) or flow (L/h). These displays are turquoise. After 60 sec they switch back to the main display.

Press **enter** to select a display as MAIN DISPLAY.

The secondary display shows "MAIN DISPLAY – NO". Use the **UP / DOWN** arrows to select "MAIN DISPLAY – YES" and confirm by pressing **enter**. The display color changes to white. This display is now shown in measuring mode.

Example:

Display of conductivity 1 and 2 and calculated pH value.

Conductivity 2 **approx. 2 s**

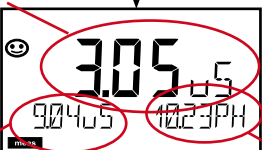

Conductivity 1

Calculated pH

Color-Coded User Interface

The color-coded user interface* guarantees increased operating safety. Operating modes are clearly signaled.

The normal measuring mode is white. Information text appears on a green screen and the diagnostic menu appears on turquoise.

The orange HOLD mode (e.g. during calibration) is quickly visible as is the magenta screen which indicates asset management messages for predictive diagnostics – such as maintenance request, pre-alarm and sensor wear.

The alarm status has a particularly noticeable red display color and is also signaled by flashing display values. Invalid inputs or false pass-codes cause the entire display to blink red so that operating errors are noticeably reduced.

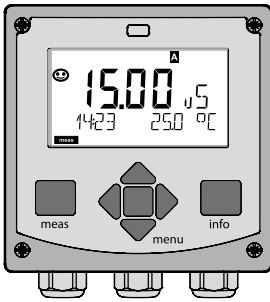

White:
Measuring mode

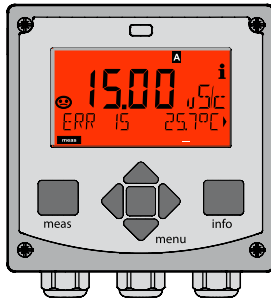

Red blinking:
Alarm, errors

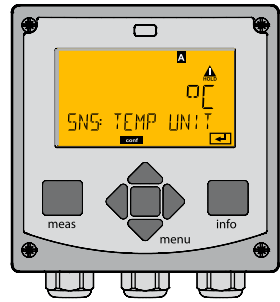

Orange:
HOLD mode

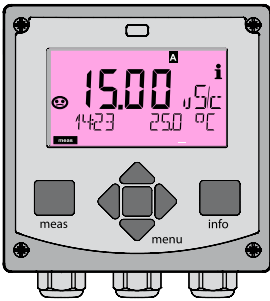

Magenta:
Maintenance request

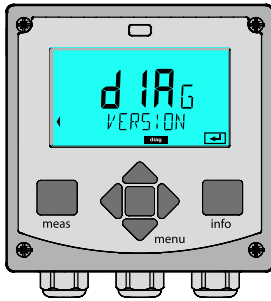

Turquoise:
Diagnostics

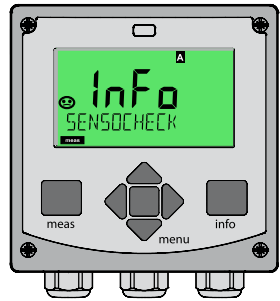

Green:
Information texts

Diagnostics

Display of calibration data, display of sensor data, performing a device self-test, viewing the logbook entries, display of hardware/software versions of the individual components. The logbook (TAN SW-A002) can store 100 events (00...99). They can be displayed directly on the device. With AuditTrail (TAN SW-A003), the logbook can be extended to 200 entries.

HOLD

Manual activation of HOLD mode, e.g. for servicing. The signal outputs adopt a defined state.

Calibration

There are no stable calibration solutions for the $\mu\text{S}/\text{cm}$ range, and performing a calibration is very difficult because it only works properly in the flow under exclusion of air. Therefore, it is easier and more precise just to enter the cell factor or calibrate by carrying out a reference measurement, if appropriate.

During calibration the device is in HOLD mode.

During calibration the device remains in the HOLD mode until it is stopped by the operator.

Configuration

The analyzer must be configured for the respective measurement task. In the "Configuration" mode you select the connected sensor, the measuring range to be transmitted, and the conditions for warning and alarm messages. During configuration the device is in HOLD mode.

Configuration mode is automatically exited 20 minutes after the last keystroke. The device returns to measuring mode.

Service

Maintenance functions (current source), passcode assignment, reset to factory settings, enabling of options (TAN).

Operating Modes / Functions

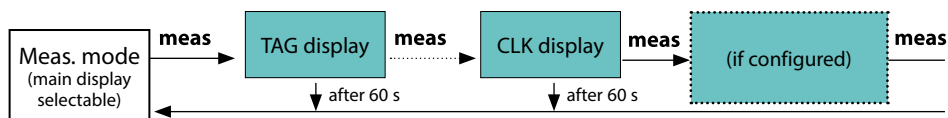

Pressing the **menu** key (down arrow) opens the selection menu.
 Select the menu group using the left/right arrow keys.
 Pressing **enter** opens a menu item. Press **meas** to return.



DIAG

CALDATA	Display of calibration data
SELFTTEST	Self test: RAM, ROM, EEPROM, module
LOGBOOK	Logbook: 100 events with date and time
MONITOR	Display of direct, uncorrected sensor signals
VERSION	Display of software version, model designation, serial no.

HOLD

Manual activation of HOLD mode, e.g., for sensor replacement.
 The signal outputs behave as configured (e.g., last measured value, 21 mA)

CAL

CAL_A	Calibrating sensor A by input of cell factor
CAL_B	Calibrating sensor B by input of cell factor

CONF

CONF	Configuration
------	---------------

SERVICE

(Access via code, factory setting: 5555)

MONITOR	Display of measured values for validation (simulators)
NEW EXCHANGER	Resetting the ion exchanger (after replacement)
OUT1	Current source, output 1
OUT2	Current source, output 2
CODES	Specifying access codes for operating modes
DEFAULT	Reset to factory setting
OPTION	Enabling an option via TAN

HOLD Mode

The HOLD mode is a safety mode during configuration, calibration, and servicing. Output current is frozen (LAST) or set to a fixed value (FIX).

The HOLD mode is indicated by orange display backlighting.

HOLD mode, display icon:



Output signal response

- **LAST:** The output current is frozen at its last value. Recommended for short configuration procedures. The process should not change decisively during configuration. Changes are not noticed with this setting!
- **FIX:** The output current is set to a value that is noticeably different from the process value to signal the control system that the analyzer is being worked at.

Output signal during HOLD:

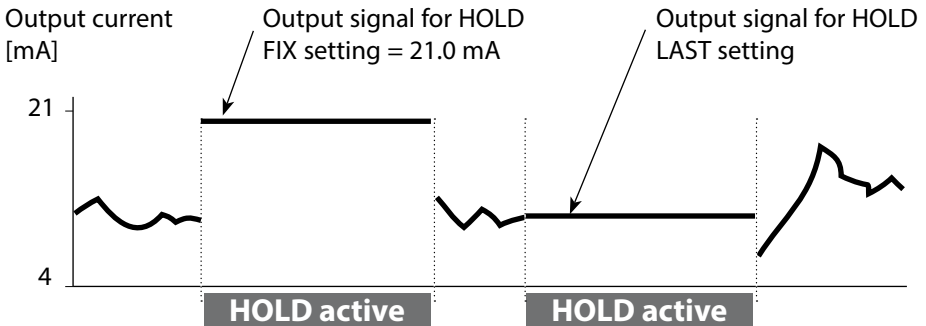

Terminating the HOLD mode

The HOLD mode is ended by switching to measuring mode (hold **meas** key depressed). The display reads “Good Bye”, after that, the HOLD mode is exited.

When the calibration mode is exited, a confirmation prompt ensures that the installation is ready for operation (e.g.: sensor reinstalled, located in process).

Alarm

External activation of HOLD (TAN SW-A005)

The HOLD mode can be activated from outside by sending a signal to the Hold input (e.g. from the process control system).

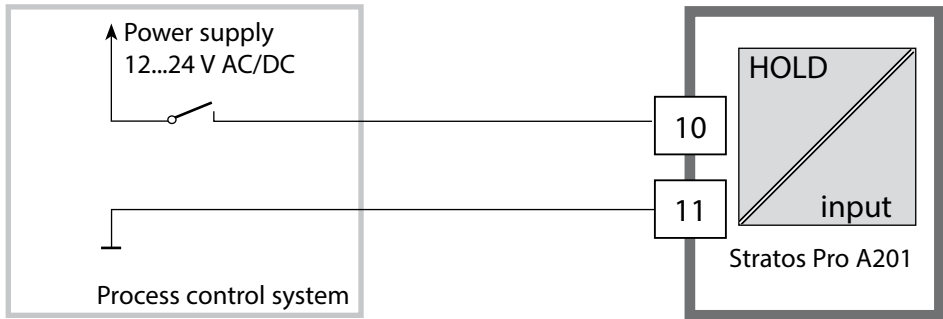

HOLD inactive	0...2 V AC/DC
---------------	---------------

HOLD active	10...30 V AC/DC
-------------	-----------------

Manual activation of HOLD

The HOLD mode can be activated manually from the HOLD menu. This allows checking or replacing a sensor, for example, without provoking unintended reactions of outputs or contacts.

Press **meas** key to return to selection menu.

Alarm

When an error has occurred, **Err xx** is displayed immediately.

Only after expiry of a user-defined delay time will the alarm be registered and entered in the logbook.

During an alarm the display blinks, the display backlighting turns **red**.

Error messages can also be signaled by a 22 mA output current (see Configuration).

2 sec after the failure event is corrected, the alarm status will be deleted.

Alarm and HOLD Messages

Message	Released by	Cause
Alarm (22 mA)	Sensocheck	Polarization / Cable
Alarm contact opens	Error messages	Flow (CONTROL input) Flow (current input) ERR A / ERR B: conductance > 250,000 μS ERR A / ERR B: conductivity > 10,000 $\mu\text{S/cm}$
HOLD (Last/Fix)	HOLD	HOLD via menu or input
	CONF	Configuration
	CAL	Calibration
	SERVICE	Service

Generating a message via the CONTROL input (TAN SW-A005)

Open the "Configuration" menu to activate the message:

CONF/CNTR_IN/CONTROL = LEVEL

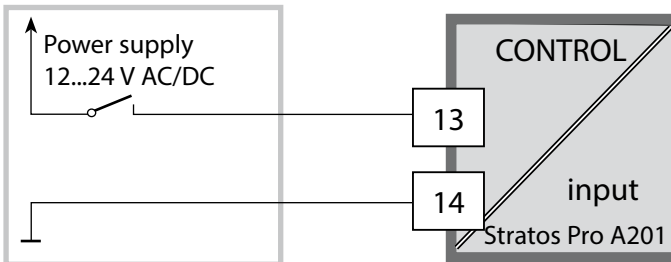

Generating a message via the current input (TAN SW-A005)

Open the "Configuration" menu to activate the message:

CONF / ALARM / LIMIT I-IN = ON (... FUNCTION, LEVEL; HYSTERESIS)

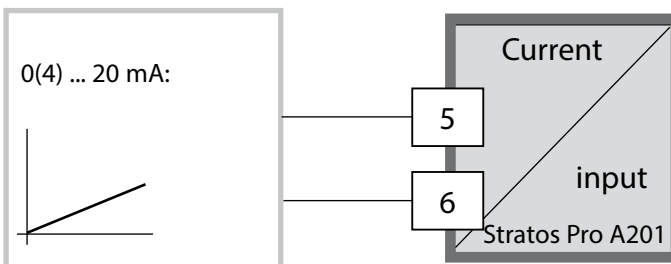

Configuration

⚠ CAUTION! Incorrect parameter settings or adjustments can result in incorrect outputs. Stratos Pro must therefore be commissioned by a system specialist, all its parameters must be set, and it must be fully adjusted. For detailed information on parameter setting and adjustment, see the user manual

Menu Structure of Configuration

The configuration steps are assigned to different menu groups.
 With the left/right arrow keys you can jump between the individual menu groups.
 Each menu group contains menu items for setting the parameters.
 Pressing **enter** opens a menu item. Use the arrow keys to edit a value.
 Press **enter** to confirm/save the settings.
 Return to measurement: Hold **meas** key depressed (> 2 s).

Select menu group	Menu group	Code	Display	Select menu item
	Sensor A parameters	S_A:	CONF [⚠] ⁱ SENSOR_A	
		Menu item 1	:	↙ enter
		Menu item ...		↙ enter
	Sensor B parameters	S_B:	CONF [⚠] ⁱ SENSOR_B	↙ enter
▶ ↙	Measuring mode	MES:	CONF [⚠] ⁱ MEAS MODE	↙ enter
▶ ↙	Current output 1	OT1:	CONF [⚠] ⁱ OUT 1	
▶ ↙	Current output 2	OT2:	CONF [⚠] ⁱ OUT 2	
▶ ↙		
▶ ↙	Display backlighting	DSP:	CONF [⚠] ⁱ DISPLAY	↙ ◀

Setup and Channel Selection on the Device

Sensors A and B – Arrangement

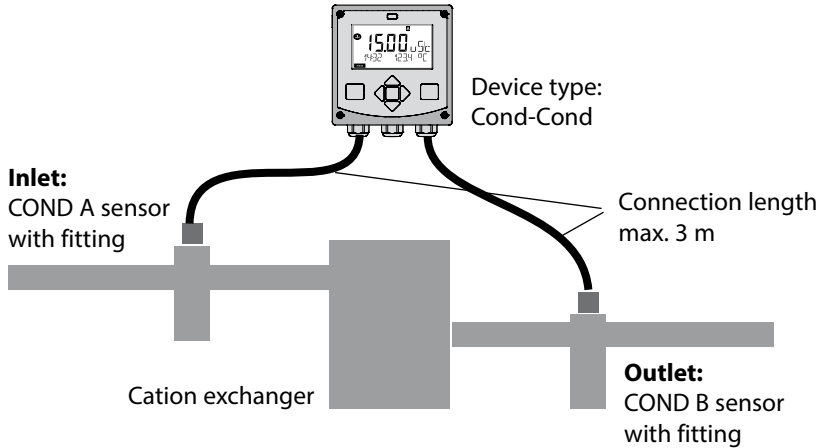

Channel Selection and Display Assignment

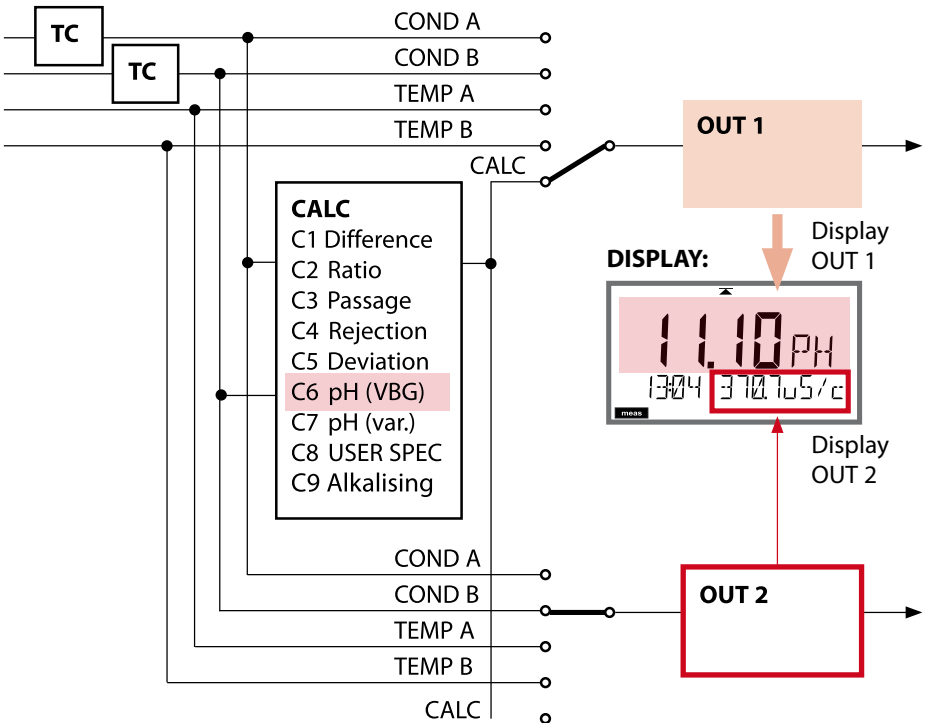

Calculations (CALC)

Calculations (CALC)

CONF	Calculation	Formula
-C1-	Difference	COND A – COND B
-C2-	Ratio	COND A / COND B
-C3-	Passage	COND B / COND A * 100
-C4-	Rejection	(COND A – COND B) / COND A * 100
-C5-	Deviation	(COND B – COND A) / COND A * 100
-C6- **	pH value acc. to VBG S-006	Additional specifications possible for calculating the consumption of the ion exchanger (size, capacity, efficiency)
	Alkalizing agent NaOH	$11 + \log((\text{COND A} - \text{COND B} / 3) / 243)$
	Alkalizing agent LiOH	$11 + \log((\text{COND A} - \text{COND B} / 3) / 228)$
	Alkalizing agent NH3	$11 + \log((\text{COND A} - \text{COND B} / 3) / 273)$
	EXCHER CAP	ON / OFF Displaying the remaining capacity: Diagnostics / Monitor menu After replacement of the ion exchanger an entry must be made in the SERVICE menu, see p. 75.
	EXCHER SIZE	Input of ion exchanger size
	CAPACITY	Input of ion exchanger capacity
	EFFICIENCY	Input of ion exchanger efficiency
-C7-	Variable pH value, factors specifiable	$C + \log((\text{Cond A} - \text{Cond B} / F1) / F2) / F3$
	COEFFICIENT	Coefficient C
	FACTOR 1	Factor F1
	FACTOR 2	Factor F2
	FACTOR 3	Factor F3

-C8-	USER SPEC* (DAC) PARAMETER W, A, B specifiable	
-C9- **	ALKALISING	Concentration of the alkalizing agent selecting NaOH, NH ₃ , LiOH
	nAOH	Concentration calculation
	nH3	Concentration calculation
	LiOH	Concentration calculation

See p. 46 for configuration.

*) Input of user-specific parameters possible

**) With C6 and C9, the concentration of the alkalizing agent can be shown in the measurement display and in the sensor monitor and it can be switched to the current outputs.

pH Value Calculation

Calculating the pH Value by Means of Dual Conductivity Measurement

When monitoring boiler feedwater in power plants, dual conductivity measurement can be used to calculate the pH value. For that purpose, the boiler feedwater conductance is measured before and after the cation exchanger. This commonly used method of indirect pH value measurement does not require much maintenance and has the following advantage:

Normal pH measurement in ultrapure water is very critical. Boiler feed water does not contain many ions. This requires the use of a special electrode, which must be calibrated constantly and the service life of which is generally rather short.

Function

Two sensors are used to measure the conductivity before and after the cation exchanger. The pH value is inferred from these two conductivity values.

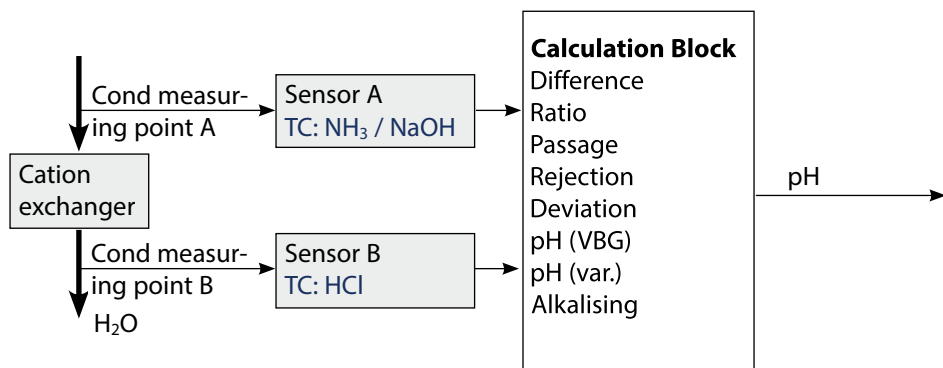

You can enter more parameters for calculating the consumption of the ion exchanger (size, capacity, efficiency). The remaining capacity is displayed in the Diagnostics / Monitor menu. After replacement of the ion exchanger an entry must be made in the SERVICE menu.

Configuration

Configuration		Choices	Default	
SENSOR A				
S_A	CELLFACTOR A ¹⁾		0.0050 ... 1.9999	0.0290
	TC SELECT		OFF LIN, NLF, NaCl HCl, NH ₃ , NaOH	OFF
	LIN	TC LIQUID	00.00 ... +19.99 %/K	00.00 %/K
SENSOR B				
S_B	CELLFACTOR B ¹⁾		0.0050 ... 1.9999	0.0290
	TC SELECT		OFF LIN, NLF, NaCl HCl, NH ₃ , NaOH	OFF
	LIN	TC LIQUID	00.00 ... +19.99 %/K	00.00 %/K
MEAS MODE				
MEAS	MEAS RANGE ²⁾ (this setting applies to both channels, A and B)		0.000 µS/cm 00.00 µS/cm 0.000 µS/cm 0000 µS/cm 00.00 MOhm	00.00 µS/cm
	TEMP UNIT		°C/°F	°C
	CALCULATION		ON/OFF	OFF
	ON	(Selected in text line)	-C1- DIFFERENCE -C2- RATIO -C3- PASSAGE -C4- REJECTION -C5- DEVIATION -C6- PH-VGB -C7- PH-VARIABLE -C8- USER SPEC -C9- ALKALISING	-C1- DIFFERENCE
	-C6-	Alkalizing agent	NaOH, NH ₃ , LiOH	NaOH
	Entries for Calculating the Consumption of the Ion Exchanger			
		EXCHER CAP ³⁾	ON / OFF	OFF
		EXCHER SIZE ³⁾	00.50 ... 5.00 LTR	00.50 LTR
		CAPACITY ³⁾	1.000 ... 5.000 VAL	1.000 VAL
		EFFICIENCY ³⁾	50.00 ... 100.0 %	100.0 %

Configuration

Configuration		Choices	Default	
MEAS MODE				
MEAS	-C7-	COEFFICIENT	00.00 ... 99.99	11.00
		FACTOR 1	0.0001 ... 9.9999	3.0000
		FACTOR 2	0001 ... 9999	0243
		FACTOR 3	0.0001 ... 9.9999	1.0000
-C8-	PARAMETER W	xxxx E-3	1000 E-3	
	PARAMETER A	xxx.x E-3	000.0 E-3	
	PARAMETER B	xxx.x E-3	000.0 E-3	
-C9-	ALKALISING	NaOH, NH3, LiOH	NaOH	

- 1) The cell constant can be modified by an entry in the configuration menu or by calibration (one storage position). This means, a cell constant determined by calibration is taken over by pressing **enter** during configuration. It remains unchanged until a new value is entered.
- 2) For conductivity ($\mu\text{S}/\text{cm}$), the range selection determines the max. resolution. If the selected range is exceeded, the device automatically switches to the next higher range until the max. measurement limit is reached (9999 $\mu\text{S}/\text{cm}$). This applies to display values and current outputs. The current outputs are adjusted using a floating-point editor which allows settings over several decades. The initial range of the editor is the selected range:

Selected resolution	Displayed range (or floating-point editor)			
	x.xxx $\mu\text{S}/\text{cm}$	xx.xx $\mu\text{S}/\text{cm}$	x.xxx $\mu\text{S}/\text{cm}$	xxxx $\mu\text{S}/\text{cm}$
x.xxx $\mu\text{S}/\text{cm}$				
xx.xx $\mu\text{S}/\text{cm}$				
xxx.x $\mu\text{S}/\text{cm}$				
xxxx $\mu\text{S}/\text{cm}$				

- 3) Entries for calculating the consumption of the ion exchanger:
 Activate with EXCHER CAP = ON.
 Messages in the Diagnostics / Monitor menu.

Configuration		Choices	Default
Output 1 (OUT1)			
OT1:	CHANNEL	COND A COND B TMP A TMP B CALC	COND A
OUTPUT		LIN / BiLIN	LIN
LIN	BEGIN 4 mA	xxxx	00.00 μ S/cm
	END 20 mA	xxxx	10.00 μ S/cm
BiLIN	BEGIN 4 mA	xxxx	00.00 μ S/cm
	END 20 mA	xxxx	10.00 μ S/cm
	CORNER X	Input range: selected CHANNEL Vertex X : $BEGIN \leq CORNER X \leq END$ (rising) $BEGIN \geq CORNER X \geq END$ (falling)	
	CORNER Y	Input range: selected CHANNEL Default: 12 mA Vertex Y: $(0) 4 \text{ mA} \leq CORNER Y \leq 20 \text{ mA}$	
TMP °C	BEGIN 4 mA	-50...200 °C	
	END 20 mA	-50...200 °C	
TMP °F	BEGIN 4 mA	-58...392 °F	
	END 20 mA	-58...392 °F	
FILTRTIME		0...120 SEC	0000 SEC
22mA FAIL		ON/OFF	OFF
22mA FACE		ON/OFF	OFF
HOLD MODE		LAST/FIX	LAST
FIX	HOLD-FIX	4...22 mA	021.0 mA
Output 2 (OUT2)			
OT2:	CHANNEL	Selection as for OUT1	COND B
All following settings are made as for output 1 (OUT1)			

Configuration

Control input (CNTR_IN)					
IN:	CONTROL		LEVEL, FLOW	FLOW	
	FLOW	FLOW ADJUST	0 ... 20000 pulses/liter	12000 pulses/liter	
Alarm (ALARM)					
ALA:	DELAYTIME		0...600 SEC	0010 SEC	
	SENSOCHECK		ON/OFF	OFF	
	FLOW CNTR *)		ON/OFF	OFF	
	ON	FLOW MIN ***)	0 ... 99.9 L/h	005.0 L/h	
		FLOW MAX***)	0 ... 99.9 L/h	025.0 L/h	
	LIMIT I-IN *)**)		ON/OFF	OFF	
	ON	FUNCTION		Lo LEVEL / Hi LEVEL	Lo LEVEL
		LEVEL		0 ... 22.00 mA	12.00 mA
		HYSTERESIS		0 ... 10.00 mA	01.00 mA

*) These menu items appear only if selected.

**) LIMIT I-IN can be used to measure and monitor the current input (e.g. flow).

For monitoring, you can enter a setpoint at which an alarm message is released:
"ERR 71 LIMIT I-INPUT" (22 mA).

***) Hysteresis fixed at 5% of threshold value

Configuration		Choices	Default	
Real-time clock (CLOCK)				
CLK:	FORMAT		24 h / 12 h	
	24 h	TIME hh/mm	00..23:00...59	
	12 h	TIME hh/mm	00 ... 12:59 AM / 01 ... 11:59 PM	
	DAY/MONTH		01...31/01...12	
	YEAR		2000...2099	
Measuring points (TAG)				
TAG:	(Input in text line)	A...Z, 0...9, - + < > ? / @		
Display backlighting (DISPLAY)				
DSP:	BACKLIGHT	On, Off	On	

Adjustable ranges of current outputs and relay contacts	
Conductivity	0.000 ... 9999 μ S/cm
M Ω	00.00 ... 99.99 M Ω cm
Temperature	-50.0 ... 200.0 $^{\circ}$ C
Flow	000.0 ... 099.9 l/h
-C1- Difference	-1999 ... 9999 μ S/cm
-C2- Ratio	00.00 ... 19.99
-C3- Passage	000.0 ... 199.9 %
-C4- Rejection	199.9 ... 199.9 %
-C5- Deviation	199.9 ... 199.9 %
-C6-/-C7- pH	-2.00 ... 16.00 pH
-C8- DAC	0.000 ... 9999 μ S/cm
-C9- Concentration	00.00 ... 99.99 ppm
Consumption calculation of ion exchanger (EXCH)	0 ... 100 %
Current input (I-INPUT)	0 ... 22 mA

Note: The adjustable ranges of the current outputs are independent of the adjusted measuring range.

Configuration (Template for Copy)

Parameter	Setting
S_A: Cell factor A	
S_A: Temperature compensation A	
S_B: Cell factor B	
S_B: Temperature compensation B	
MEAS: Measuring range	
MEAS: Temperature unit	
MEAS: Calculation	
MEAS: Coefficient C (for variable pH only, -C7-)	
MEAS: Factor F1 (for variable pH only, -C7-)	
MEAS: Factor F2 (for variable pH only, -C7-)	
MEAS: Factor F3 (for variable pH only, -C7-)	
MEAS: Parameter W (for USER SPEC only, -C8-)	
MEAS: Parameter A (for USER SPEC only, -C8-)	
MEAS: Parameter B (for USER SPEC only, -C8-)	
MEAS: Alkalizing agent (for variable pH only, -C9-)	
OT1: Parameter (channel)	
OT1: Linear / Bilinear curve	
OT1: Current start	
OT1: Current end	
OT1: Vertex X (bilinear curve only)	
OT1: Vertex Y (bilinear curve only)	
OT1: Filter time	
OT1: FAIL 22 mA (error messages)	
OT1: FACE 22 mA (Sensoface messages)	
OT1: HOLD mode	
OT1: HOLD FIX current	
OT2: Parameter (CHANNEL)	
OT2: Linear / Bilinear curve	
OT2: Current start	
OT2: Current end	
OT2: Vertex X (bilinear curve only)	
OT2: Vertex Y (bilinear curve only)	

Configuration (Template for Copy)

Parameter	Setting
OT2: Filter time	
OT2: FAIL 22 mA (error messages)	
OT2: FACE 22 mA (Sensoface messages)	
OT2: HOLD mode	
OT2: HOLD FIX current	
IN: Level or flow	
IN: (Flow meter) Adjusting pulses/liter	
ALA: Delay	
ALA: Sensocheck on/off	
ALA: Flow control FLOW CNTR on/off	
ALA: Minimum flow (hysteresis fixed at 5 %)	
ALA: Maximum flow (hysteresis fixed at 5 %)	
ALA: Monitoring of current input LIMIT I-IN on/off	
ALA: FUNCTION (LO LEVEL / Hi LEVEL)	
ALA: LEVEL (monitored threshold)	
ALA: HYSTERESIS	
CLK: Time format	
TAG: Measuring point (tag number)	
DISPLAY: Display backlighting	

Configuration

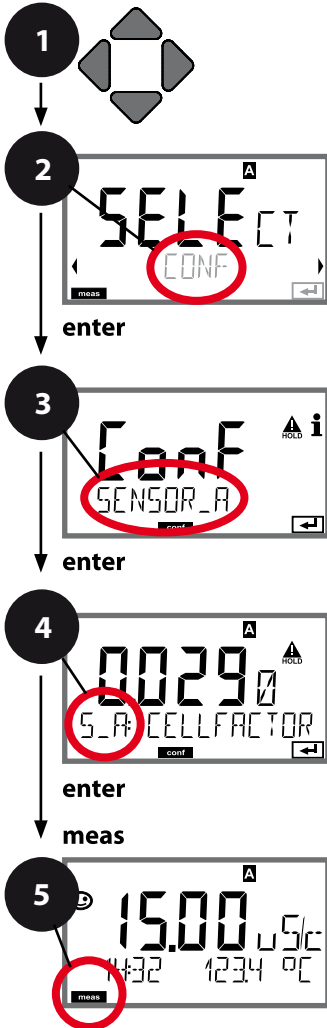

Configuring Sensors A, B

Specifying cell factor, selecting temperature compensation

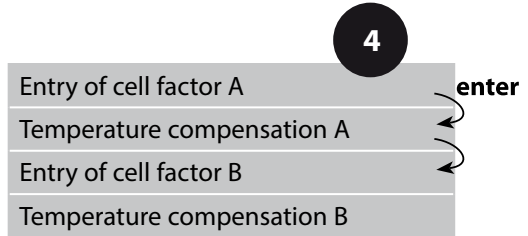

- 1) Press **menu** key.
- 2) Select **CONF** using ◀ ▶ keys, press **enter**.
- 3) Select **SENSOR_A** menu using ◀ ▶ keys, press **enter**.
- 4) All items of this menu group are indicated by the "S_A:" code.
Press **enter** to select menu, edit using arrow keys (see next page).
Confirm (and proceed) using **enter**.
- 5) End: Press **meas** key until the [meas] mode indicator is displayed.

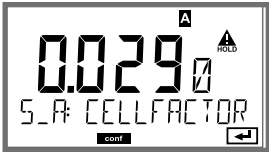
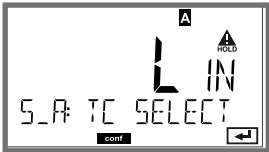

Menu item	Action	Choices
Sensor A 	Select SENSOR_A menu using ◀ ▶ keys, press enter .	
Enter cell factor Sensor A 	Modify digit using ▲ ▼ keys, select next digit using ◀ ▶ keys. Press enter to confirm.	0.0050...1.9999 (0.0290)
Temp compensation selection 	Select using ▲ ▼ keys. Press enter to confirm.	OFF LIN* NLF NaCl HCl NH3 NaOH * With LIN selected: Enter temperature coefficient 00.00 %/K ... +19.99 %/K
Sensor B 	Select SENSOR_B menu using ◀ ▶ keys, press enter .	
Enter cell factor Sensor B...	Configuration as for sensor A	



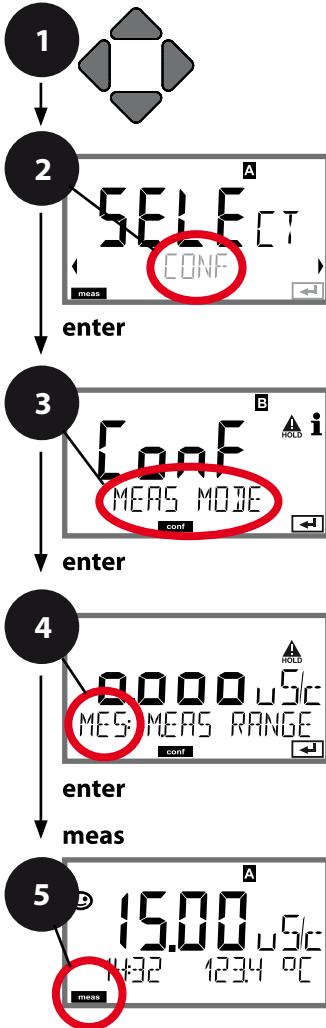

Configuration

Measuring Range, Calculation of Output Parameters

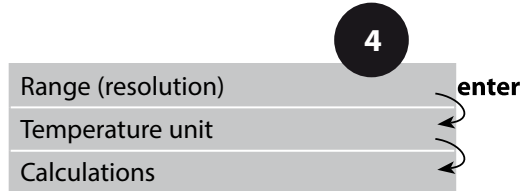

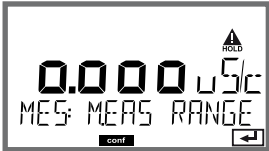
- 1) Press **menu** key.
- 2) Select **CONF** using ◀ ▶ keys, press **enter**.
- 3) Select **MEAS MODE** menu using ◀ ▶ keys, press **enter**.
- 4) All items of this menu group are indicated by the "MES:" code.
Press **enter** to select menu, edit using arrow keys (see next page). Confirm (and proceed) using **enter**.
- 5) End: Press **meas** key until the [meas] mode indicator is displayed.



Menu item	Action	Choices
Range (resolution) 	Select using ▲ ▼ keys. Press enter to confirm.	0.000 $\mu\text{S}/\text{cm}$ 00.00 $\mu\text{S}/\text{cm}$ 000.0 $\mu\text{S}/\text{cm}$ 0000 $\mu\text{S}/\text{cm}$ 00.00 MOhm
Temperature unit	Select °C or °F using ▲ ▼ keys. Press enter to confirm.	°C / °F
Calculation 	Select using ▲ ▼ keys. Press enter to confirm.	ON, OFF
Calculation type 	Select desired calculation type using ▲ ▼ keys: Press enter to confirm.	-C1- DIFFERENCE -C2- RATIO -C3- PASSAGE -C4- REJECTION -C5- DEVIATION -C6- PH-VGB -C7-PH-VARIABLE -C8- USER SPEC -C9- ALKALISING
	With -C6- ... -C9- selected, you are request- ed to enter parameters.	-C6- pH VGB S-006 -C7- COEFFICIENT: 11.00 (00.00 ... 99.99) -C7- Factor 1: 3.0000 (0.0001 ... 9.9999) -C7- Factor 2: 0243 (0001 ... 9999) -C7- Factor 3: 1.0000 (0.0001 ... 9.9999) -C8- Parameter W: (xxxx E-3 1000 E-3) -C8- Parameter A: (xxx.x E-3 000.0 E-3) -C8- Parameter B: (xxx.x E-3 000.0 E-3) -C9- Alkalisig: (NaOH, LiOH, NH3)

Configuration

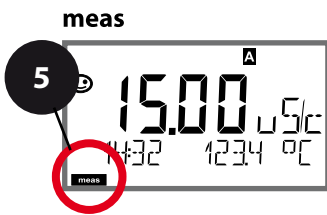
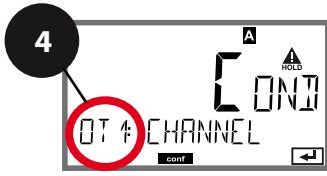
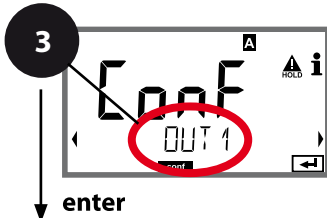
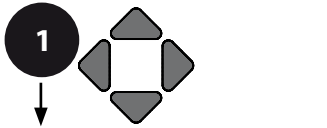

Current Output 1

Process variable. Current start. Current end.



- 1) Press **menu** key.
- 2) Select **CONF** using ◀ ▶ keys, press **enter**.
- 3) Select **OUT1** menu using ◀ ▶ keys, press **enter**.
- 4) All items of this menu group are indicated by the "OT1:" code.
Press **enter** to select menu, edit using arrow keys (see next page). Confirm (and proceed) using **enter**.
- 5) End: Press **meas** key until the [meas] mode indicator is displayed.

CHANNEL: Channel selection (process variable)
OUTPUT: LIN: linear curve biLIN: bilinear curve
Current start/end
Bilinear: vertex X/Y
Time averaging filter
Output current for error message
Output current for Sensoface
Output current during HOLD
Output current for HOLD FIX

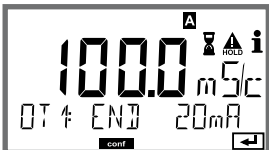
Menu item	Action	Choices
Process variable 	Select using \blacktriangle \blacktriangledown keys: Cond: Conductivity TMP: Temperature CALC: Calculation Press enter to confirm.	Cond A Cond B TMP A TMP B CALC
Current start 	Modify digit using \blacktriangle \blacktriangledown keys, select next digit using \blacktriangleleft \blacktriangleright keys. Press enter to confirm.	As selected for process variable/range If the adjusted range is exceeded, the device automatically switches to the next higher range (Autorange)
Current end 	Enter value using \blacktriangle \blacktriangledown \blacktriangleleft \blacktriangleright keys. Press enter to confirm.	As selected for process variable/range If the adjusted range is exceeded, the device automatically switches to the next higher range (Autorange)

Assignment of measured values: Current start and current end

Example 1: Range 0...200 $\mu\text{S}/\text{cm}$

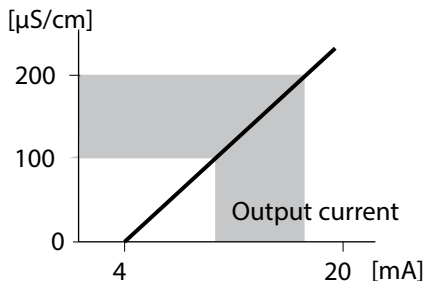

Example 2: Range 100...200 $\mu\text{S}/\text{cm}$

Advantage: Higher resolution in range of interest

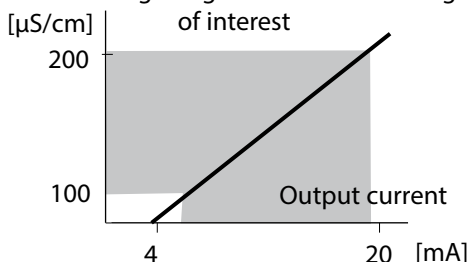

Configuration

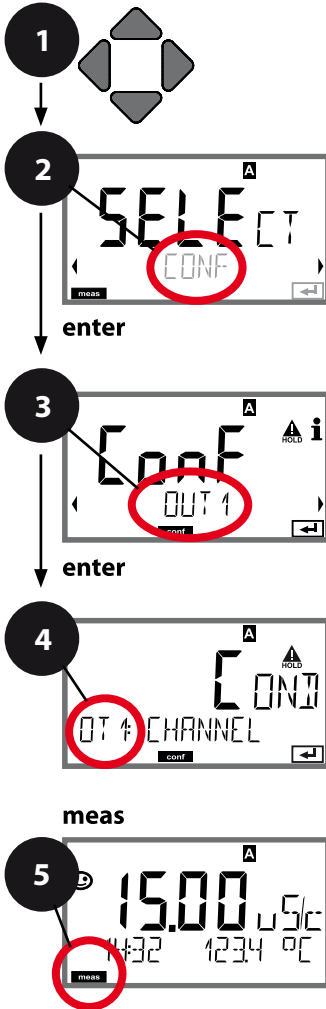

Current Output 1 Output current curve



- 1) Press **menu** key.
- 2) Select **CONF** using ◀ ▶ keys, press **enter**.
- 3) Select **OUT1** menu using ◀ ▶ keys, press **enter**.
- 4) All items of this menu group are indicated by the "OT1:" code.
Press **enter** to select menu, edit using arrow keys (see next page). Confirm (and proceed) using **enter**.
- 5) End: Press **meas** key until the [meas] mode indicator is displayed.

4

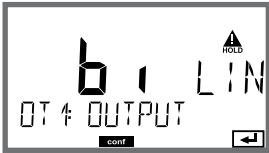
CHANNEL: Channel selection (process variable)	enter
OUTPUT:	
LIN: linear curve	
biLIN: bilinear curve	
Current start/end	
Bilinear: vertex X/Y	
Time averaging filter	
Output current for error message	
Output current for Sensoface	
Output current during HOLD	
Output current for HOLD FIX	

Menu item	Action	Choices
Output current curve 	Select using ▲ ▼ keys. Press enter to confirm.	LIN Linear curve biLIN Bilinear curve
Current start and current end 	Enter value using ▲ ▼ ◀ ▶ keys. Press enter to confirm.	Entered value applies to selected process variable/range If the adjusted range is exceeded, the device automatically switches to the next higher range (Autorange)
Bilinear curve: Vertex X/Y 	Enter value using ▲ ▼ ◀ ▶ keys. Press enter to confirm.	Entered value applies to selected vertex of bilinear curve "Corner X" (process variable) and "Corner Y" (output current) – see figure below.

Vertex of bilinear curve

Output current

[mA]

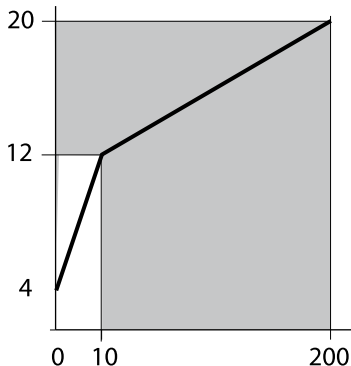

Example:

Current range set to 4 ... 20 mA,

Current start: 0 µS/cm

Current end: 200 µS/cm

Vertex:

"CORNER X": 10 µS/cm (process variable)

"CORNER Y": 12 mA (output current)

Result: The output current change in the range 0 ... 10 µS/cm is much greater than in the range 10 ... 200 µS/cm.

Process variable
[µS/cm]

Configuration

Current Output 1

Adjusting time interval of output filter

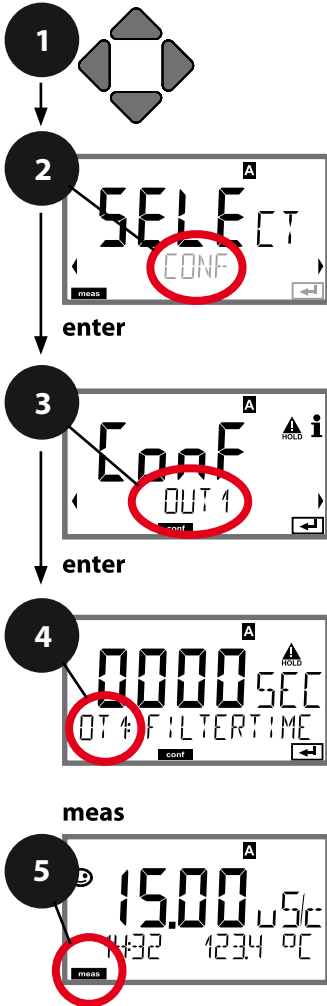

- 1) Press **menu** key.
- 2) Select **CONF** using **◀ ▶** keys, press **enter**.
- 3) Select **OUT1** menu using **◀ ▶** keys, press **enter**.
- 4) All items of this menu group are indicated by the "OT1:" code.
Press **enter** to select menu, edit using arrow keys (see next page). Confirm (and proceed) using **enter**.
- 5) End: Press **meas** key until the [meas] mode indicator is displayed.

CHANNEL: Channel selection (process variable)	4 enter
OUTPUT: LIN: linear curve biLIN: bilinear curve	
Current start/end	
Bilinear: vertex X/Y	
Time averaging filter	
Output current for error message	
Output current for Sensoface	
Output current during HOLD	
Output current for HOLD FIX	

Menu item	Action	Choices
Time averaging filter	Enter value using ▲ ▼ ◀ ▶ keys. Press enter to confirm.	0...120 SEC (0000 SEC)

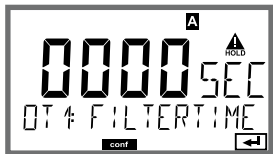

Time averaging filter

To smoothen the current output, a low-pass filter with adjustable filter time constant can be switched on. When there is a jump at the input (100 %), the output level is at 63 % after the time interval has been reached. The time interval can be set from 0 to 120 sec. If the time interval is set to 0 sec, the current output directly follows the input.

Please note:

The filter only acts on the current output, not on the display or the limit value!

During HOLD the filter is not applied. This prevents a jump at the output.

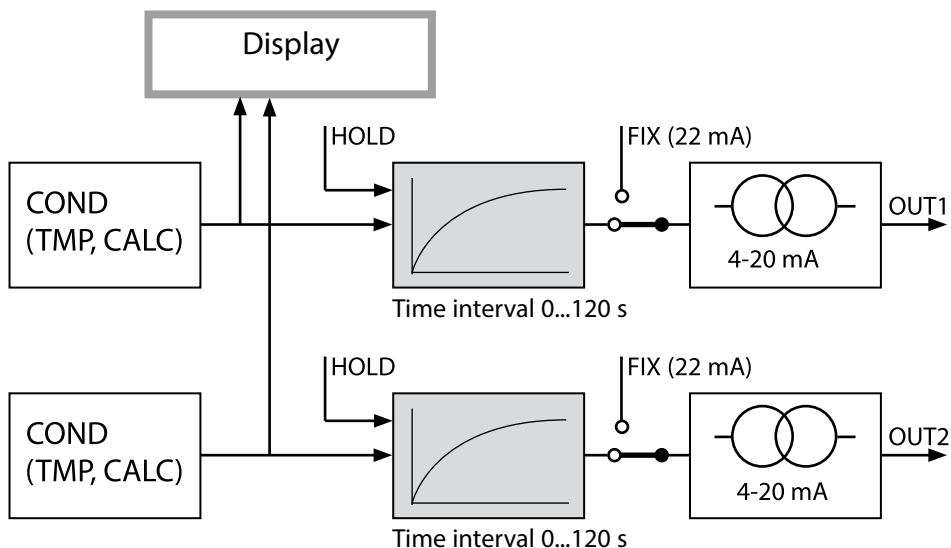

Configuration

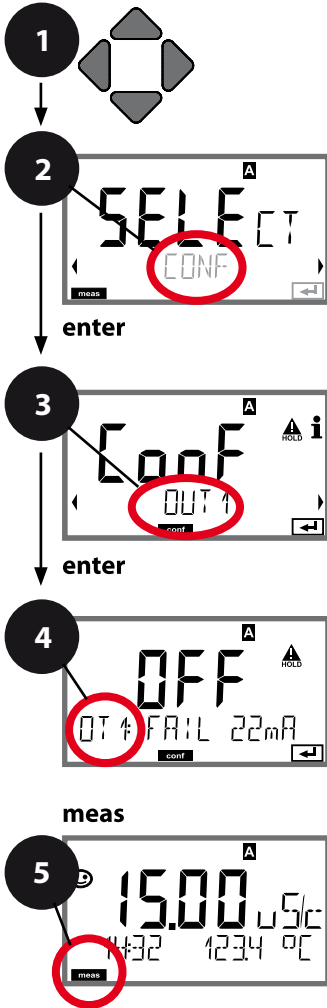

Current Output 1

Output current during Error and HOLD

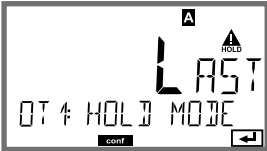

- 1) Press **menu** key.
- 2) Select **CONF** using ◀ ▶ keys, press **enter**.
- 3) Select **OUT1** menu using ◀ ▶ keys, press **enter**.
- 4) All items of this menu group are indicated by the "OT1:" code.
Press **enter** to select menu, edit using arrow keys (see next page). Confirm (and proceed) using **enter**.
- 5) End: Press **meas** key until the [meas] mode indicator is displayed.

	4
CHANNEL: Channel selection (process variable)	↪ enter
OUTPUT: LIN: linear curve biLIN: bilinear curve	
Current start/end	
Bilinear: vertex X/Y	
Time averaging filter	
Output current for error message	
Output current for Sensoface	
Output current during HOLD	
Output current for HOLD FIX	

Menu item	Action	Choices
Output current during error message 	Select ON (22 mA for error message) or OFF using ▲ ▼ keys. Press enter to confirm.	ON/OFF
Output current during Sensoface messages OT1: FACE 22 mA	Select ON or OFF using ▲ ▼ keys. Confirm by pressing enter	ON/OFF
Output current during HOLD 	LAST: During HOLD the last measured value is maintained at the output. FIX: During HOLD a value (to be entered) is maintained at the output. Select using ▲ ▼ Press enter to confirm.	LAST/FIX
Output current for HOLD FIX 	Only with FIX selected: Enter current which is to flow at the output during HOLD Enter value using ▲ ▼ ◀ ▶ keys. Press enter to confirm.	04.00...22.00 mA (21.00 mA)

Output signal during HOLD:

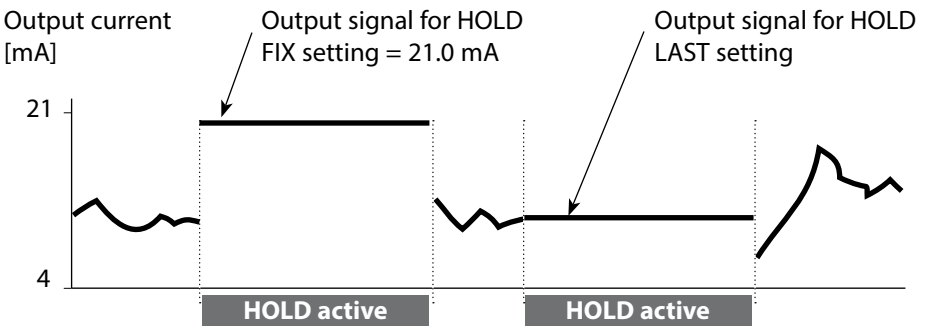

Configuration

Current Output 2

Output current range. Process variable.

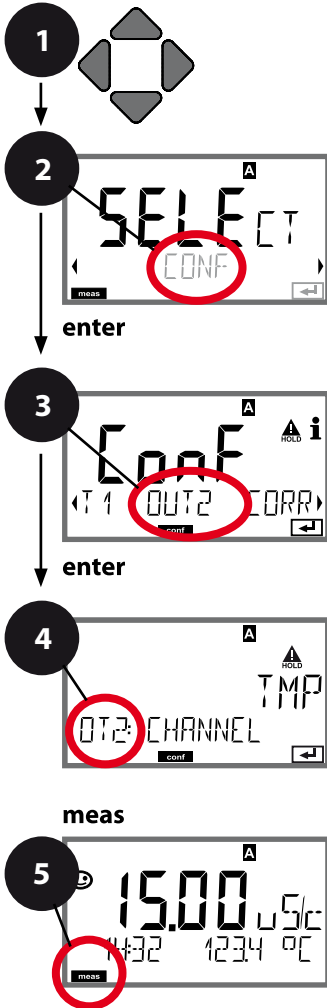

- 1) Press **menu** key.
- 2) Select **CONF** using ◀ ▶ keys, press **enter**.
- 3) Select **OUT2** menu using ◀ ▶ keys, press **enter**.
- 4) All items of this menu group are indicated by the "OT2:" code.
Press **enter** to select menu, edit using arrow keys (see next page). Confirm (and proceed) using **enter**.
- 5) End: Press **meas** key until the [meas] mode indicator is displayed.

4

CHANNEL: Channel selection (process variable)	enter
OUTPUT:	
LIN: linear curve	
biLIN: bilinear curve	
Current start/end	
Bilinear: vertex X/Y	
Time averaging filter	
Output current for error message	
Output current for Sensoface	
Output current during HOLD	
Output current for HOLD FIX	

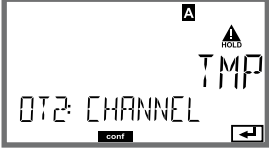
Menu item	Action	Choices
Process variable 	Select using ▲ ▼ keys: Cond: Conductivity TMP: Temperature Press enter to confirm.	Cond A Cond B TMP A TMP B CALC
<ul style="list-style-type: none"> • • • 		

All the following adjustments are made as for current output 1 (see there)!



Configuration

CONTROL Input (TAN SW-A005)

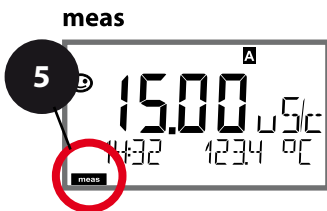
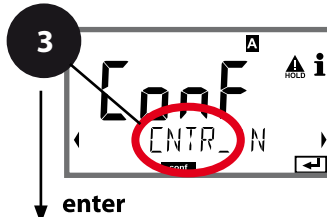
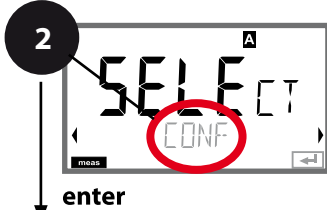
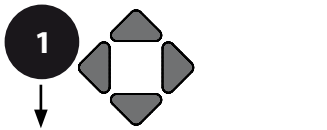
Flow measurement

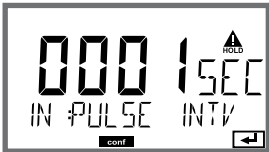

- 1) Press **menu** key.
- 2) Select **CONF** using ◀ ▶ keys, press **enter**.
- 3) Select **CNTR_IN** menu using ◀ ▶ keys, press **enter**.
- 4) All items of this menu group are indicated by the "IN:" code.
Press **enter** to select menu, edit using arrow keys (see next page). Confirm (and proceed) using **enter**.
- 5) End: Press **meas** key until the [meas] mode indicator is displayed.

Menu item	Action	Choices
Select function of CONTROL input 	Select using ▲ ▼ keys. Press enter to confirm.	Level Flow (for connecting a pulse-output flow meter)
Adjust to flow meter 	With "Flow" selected, you must adjust the device to the flow meter used. Enter value using arrow keys. Press enter to confirm.	12000 pulses/liter
Set the pulse recording interval: 	Enter value using ▲ ▼ ◀ ▶ keys. Press enter to confirm.	1...20 SEC (0001 SEC)

In the alarm menu you can configure flow monitoring. When you have set CONTROL to FLOW, you can specify 2 additional limit values for maximum and minimum flow.

If the measured value lies outside this range, an alarm message and a 22-mA error signal (if configured) will be generated.

Display

Flow measurement in measuring mode



Display

Flow measurement (sensor monitor)



Configuration

Alarm Settings

Delay. Sensocheck.

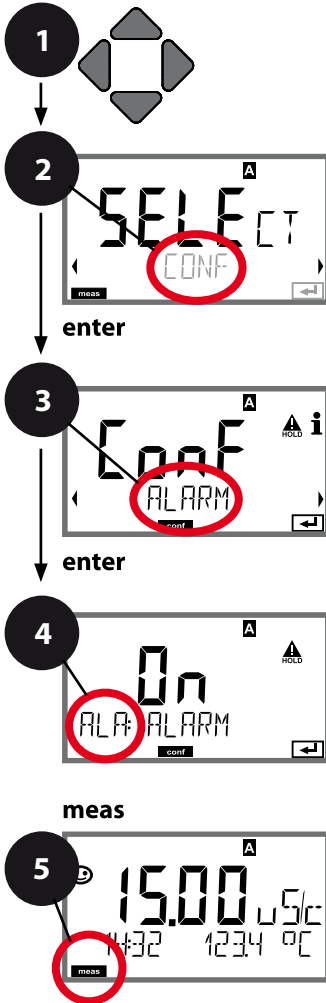

- 1) Press **menu** key.
- 2) Select **CONF** using ◀ ▶ keys, press **enter**.
- 3) Select **ALARM** menu using ◀ ▶ keys, press **enter**.
- 4) All items of this menu group are indicated by the "ALA:" code.
Press **enter** to select menu, edit using arrow keys (see next page). Confirm (and proceed) using **enter**.
- 5) End: Press **meas** key until the [meas] mode indicator is displayed.

4

ALARM: Delay

Alarm: Sensocheck

Alarm: CONTROL input

For flow monitoring:



Max. flow alarm

For flow monitoring:

Min. flow alarm

Error messages can be signaled by a 22 mA output current (see Error Messages and Configuration of Output 1/Output 2).

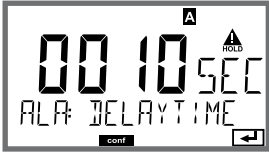
The alarm delay time delays the color change of the display back-lighting to red and the 22 mA signal (if configured).

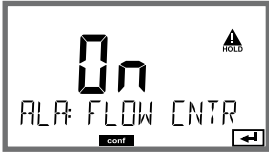
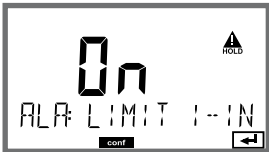
Menu item	Action	Choices
Delay 	Enter value using ▲ ▼ ◀ ▶ keys. Press enter to confirm.	0...600 SEC (010 SEC)
Sensocheck 	Select Sensocheck (con- tinuous monitoring of sensor). Select ON or OFF using ▲ ▼ keys. Press enter to confirm.	ON/OFF
CONTROL input  	The CONTROL input can generate an alarm depending on its assign- ment in the CONF menu: FLOW (flow measure- ment): allows monitoring the minimum and maxi- mum flow (pulse counter) LEVEL (control input): Level monitoring.	ON/OFF (FLOW MIN, FLOW MAX.)
Current input 	LIMIT I-IN Monitoring a flow meter (4 ... 20 mA) for a limit value, either MIN (Lo LEVEL) or MAX (Hi LEVEL). Press enter to confirm.	Lo LEVEL / Hi LEVEL
LEVEL	Threshold value	0 ... 22.00 mA (12.00 mA)
HYSTERESIS	Hysteresis	0 ... 10.00 mA (01.00 mA)

Configuration

Time and Date

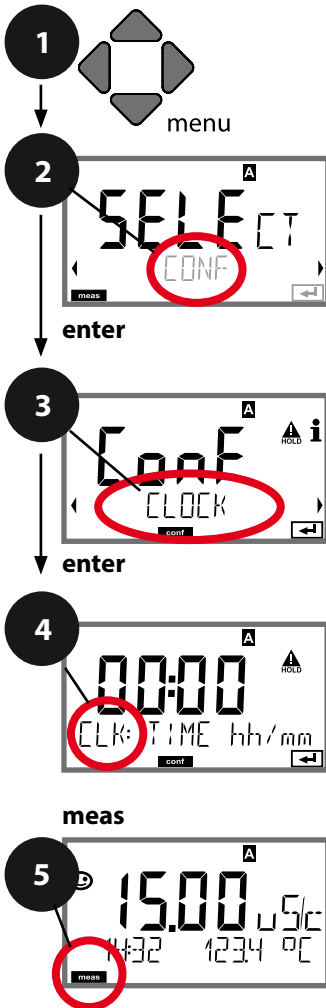

- 1) Press **menu** key.
- 2) Select **CONF** using ◀ ▶, press **enter**.
- 3) Select **ELCK** using ◀ ▶ keys, press **enter**.
- 4) All items of this menu group are indicated by the "CLK:" code. Press **enter** to select menu, edit using arrow keys (see next page). Confirm (and proceed) by pressing **enter**.
- 5) Exit: Press **meas** key until the [meas] mode indicator is displayed.

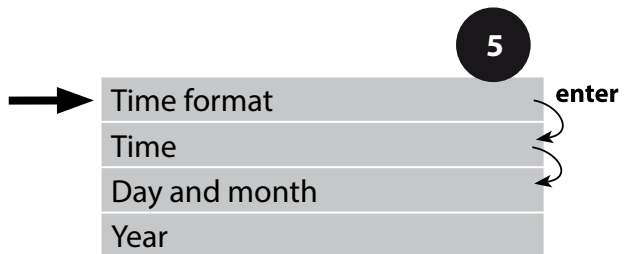

Time and Date

Control of the calibration and cleaning cycles is based on the time and date of the integrated real-time clock.

In measuring mode the time is shown in the lower display. When using digital sensors, the calibration data is written in the sensor head. In addition, the logbook entries (cf Diagnostics) are provided with a time stamp.

Note:

There is no automatic switchover from winter to summer time!

Be sure to manually adjust the time!

Configuration

Measuring Point (TAG) Display Backlighting

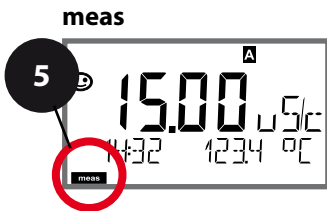
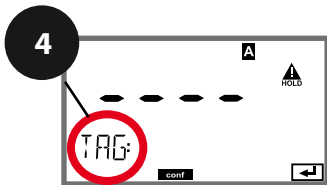
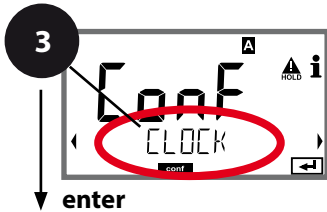
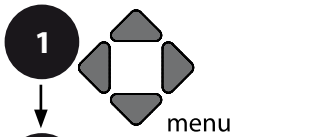

- 1) Press **menu** key.
- 2) Select **CONF** using $\leftarrow \rightarrow$, press **enter**.
- 3) Select **TAG** or **DISPLAY** using $\leftarrow \rightarrow$ keys, press **enter**.
- 4) All items of this menu group are indicated by the "TAG:" or "DSP" code. Press **enter** to select menu, edit using arrow keys (see next page). Confirm (and proceed) by pressing **enter**.
- 5) Exit: Press **meas** key until the [meas] mode indicator is displayed.

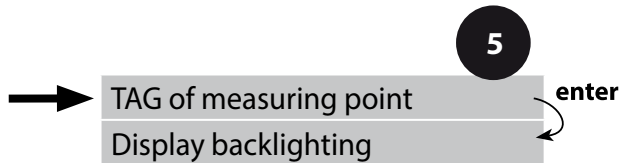

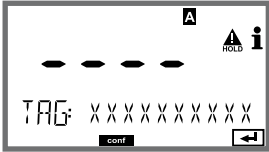
Menu item	Action	Choices
<p>Measuring point (TAG)</p> 	<p>In the lower display line you can enter a designation for the measuring point (TAG) and for a group of measuring points (GROUP) if applicable. Up to 32 digits are possible. Select character using ▲ ▼ keys, select next digit using ◀ ▶ keys. Press enter to confirm. By pressing meas (repeatedly) in the measuring mode you can view the tag number.</p>	<p>A...Z, 0...9, – + < > ? / @</p> <p>The first 10 characters are seen in the display without scrolling.</p>

Switch Off the Display Backlighting

The display backlighting can be switched off in the DISPLAY menu.

Note: If the display backlighting is off, color signaling of error events is not possible.

Calibration





Note:

- All calibration procedures must be performed by trained personnel. Incorrectly set parameters may go unnoticed, but change the measuring properties.

Each sensor is calibrated separately by entering the cell factor.

Calibration by Input of Cell Factor

You can directly enter the value for the cell factor of a sensor. This value must be known, i.e., determined beforehand in the laboratory, for example. The selected process variable and the temperature are displayed.

Display	Action	Remark
	<p>Select Calibration. Press enter to proceed. Select CAL_CELL_A (or CAL_CELL_B) calibration method. Press enter to proceed.</p>	<p>The calibration procedure is identical for sensor A and sensor B. The selection (A or B) is indicated in the upper display line.</p>
	<p>Ready for calibration. Hourglass blinks.</p>	<p>Display (3 sec) Now the device is in HOLD mode.</p>
	<p>Enter cell factor. Press enter to proceed.</p>	<p>The selected process variable and the temperature are displayed.</p>
	<p>The device shows the calculated cell factor (at +25 °C / +77 °F). Sensoface is active.</p>	
	<p>Use the arrow keys to select:</p> <ul style="list-style-type: none"> • MEAS (exit) • REPEAT <p>Press enter to proceed.</p>	<p>Exit: HOLD is deactivated after a short time.</p>

Measurement

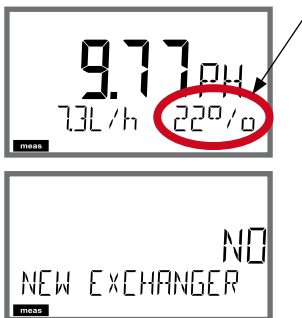
Display	Remark
	<p>From the configuration or calibration menus, you can switch the device to measuring mode by pressing the meas key (> 2 sec). In the measuring mode the upper display line shows the configured process variable, the lower display line shows the time and the second configured process variable. The [meas] mode indicator lights.</p> <p>Note:</p> <ul style="list-style-type: none"> • After prolonged power outage (> 5 days) the time display is replaced by dashes and cannot be used for processing. In that case, enter the correct time.
<p>By pressing the meas key you can step through different displays. When no key has been pressed for 60 sec, the device returns to the display which has been selected as MAIN DISPLAY, see page 25.</p>	
<p>Depending on the configuration, one of the following displays can be set as standard display (MAIN DISPLAY) for the measuring mode.</p> <ol style="list-style-type: none"> 1) Display of tag number ("TAG") with up to 32 digits 2) Conductivity and temperature of channel A 3) Conductivity and temperature of channel B 4) Display of time and date 5) Measured values of channel A, channel B and flow 6) Output currents 	
	<p>When displaying the remaining capacity of the ion exchanger, the device can be directly informed of a replaced ion exchanger.</p> <ol style="list-style-type: none"> 1) Press the enter key to show the following display: NEW EXCHANGER NO 2) Use ◀ ▶ to select YES 3) Press enter to confirm <p>See also page 75, "Service" chapter.</p>

In the Diagnostics mode you can access the following menus without interrupting the measurement:

CALDATA	Viewing the calibration data
SELFTTEST	Starting a device self-test
LOGBOOK	Viewing the logbook entries
MONITOR	Displaying currently measured values, incl. remaining capacity of the ion exchanger (if provided)
VERSION	Displaying device type, software version, serial number

Access to diagnostics can be protected with a passcode (SERVICE menu).

Note:

HOLD is not active during Diagnostics mode!

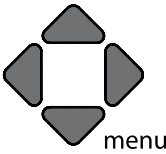
Action	Key	Remark
Activate diagnostics		Pressing the menu key (down arrow) opens the selection menu. (Display color changes to turquoise.) Select DIAG using ◀ ▶ keys, confirm by pressing enter
Select diagnostics option		Use ◀ ▶ keys to select from: CALDATA SELFTTEST LOGBOOK MONITOR VERSION See next pages for further proceeding.
Exit	meas	Exit by pressing meas .

Diagnostics

Menu item	Remark
	<p>Display of calibration data Select CALDATA using ◀ ▶, press enter to confirm. Use the ◀ ▶ keys to select the desired parameter from the bottom line of the display (LAST CAL CELL_A CELL_B). The selected parameter is shown in the main display.</p> <p>Press meas to return to measurement.</p>

Display

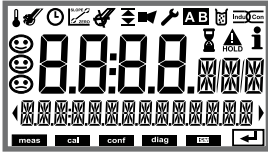

Menu item

Device self-test

(To abort, you can press **meas.**)

- 1) **Display test:** Display of all segments with changing background colors white/green/red. Proceed by pressing **enter**.





- 2) **RAM test:** Hourglass blinks, then display of --PASS-- or --FAIL-- Proceed by pressing **enter**.



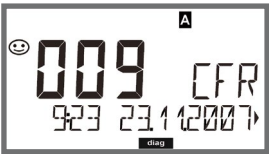

- 3) **EEPROM test:** Hourglass blinks, then display of --PASS-- or --FAIL-- Proceed by pressing **enter**.

- 4) **FLASH test:** Hourglass blinks, then display of --PASS-- or --FAIL-- Proceed by pressing **enter**.

- 5) **Module test:** Hourglass blinks, then display of --PASS-- or --FAIL-- Press **enter** or **meas** to return to measuring mode.

Diagnostics

Menu item	Remark
  	<p>Display of logbook entries Select LOGBOOK using ◀ ▶, press enter to confirm.</p> <p>Using the ▲ ▼ keys, you can scroll backwards and forwards through the logbook (entries -00-...-99-), -00- being the last entry.</p> <p>If the display is set to date/time, you can search for a particular date using the ▲ ▼ keys. Press ◀ ▶ to view the corresponding message text.</p> <p>If the display is set to the message text, you can search for a particular message using the ▲ ▼ keys. Press ◀ ▶ to display the date and time.</p> <p>Press meas to return to measurement.</p>
	<p>Extended logbook / Audit Trail (via TAN) With the ▲ ▼ keys, you can scroll backwards and forwards through the extended logbook (entries -000-...-199-), -000- being the last entry.</p> <p>Display: CFR Audit Trail also records function activations (CAL CONFIG SERVICE), some Sensoface messages and opening of the enclosure.</p>
 <p>Display example:</p> 	<p>Display of currently measured values (sensor monitor): Select MONITOR using ◀ ▶, press enter to confirm. Use the ◀ ▶ keys to select the desired parameter from the bottom line of the display: R_COND_A, R_COND_B, G_COND_A, G_COND_B (all these apply to cell factor = 1), RTD_A, RTD_B, TEMP_A, TEMP_B, FLOW, I-INPUT (Option) EXCHANGER CAP (when switched on). The selected parameter is shown in the main display.</p> <p>Press meas to return to measurement.</p>

Display	Remark
<p>Remaining capacity of the ion exchanger</p> 	<p>When calculating the consumption of the ion exchanger has been activated in the configuration, the sensor monitor shows the remaining capacity of the ion exchanger.</p> <p>Press meas to return to measurement.</p>
	<p>Version</p> <p>Here, you find the data you require for requesting a device-specific option.</p> <p>Use the ▲ ▼ keys to switch between software and hardware version. Press enter to proceed to next device component.</p>
	<p>Display of device type and serial number of device. Use the ▲ ▼ keys to switch between software and hardware version. Press enter to proceed to next device component.</p>
	<p>Display of software/hardware version and serial number for device components. (here: measuring module)</p> <p>Use the ▲ ▼ keys to switch between software and hardware version. Press enter to proceed to next device component.</p>
	<p>Display of software version of HART interface. Press enter to proceed to next device component.</p>



Service



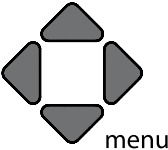

In the Service mode you can access the following menus:

MONITOR	Displaying currently measured values
SENSOR	Resetting TTM (ISM only), incrementing the autoclaving counter
OUT1	Testing current output 1
OUT2	Testing current output 2
CODES	Assigning and editing passcodes
DEFAULT	Resetting the device to factory settings
OPTION	Enabling options via TAN.

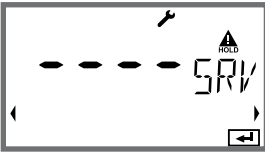

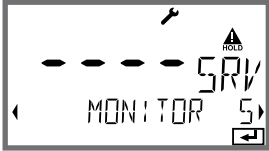
Note:

HOLD is active during Service mode!















Action	Key/Display	Remark
Activate Service		Press menu key to call the selection menu. Select SERVICE using ◀ ▶ keys, press enter to confirm.
Passcode		Enter passcode "5555" for service mode using the ▲ ▼ ◀ ▶ keys. Press enter to confirm.
Display		In service mode the following icons are displayed: <ul style="list-style-type: none"> • [diag] mode indicator • HOLD triangle • Service (wrench)
Exit	meas	Exit by pressing meas .

Menu item	Remark
	<p>Displaying currently measured values (sensor monitor) with HOLD mode activated: Select MONITOR using ◀ ▶, press enter to confirm. Select variable in the bottom text line using ◀ ▶. The selected parameter is shown in the upper display line.</p> <p>As the device is in HOLD mode, you can perform validations using simulators without influencing the signal outputs.</p> <p>Return to Service menu: Hold meas depressed for longer than 2 sec. Press meas once more to return to measurement.</p>
Display example:	
	
NEW EXCHANGER	<p>For calculating the pH according to VGB (-C6-), the consumption of the ion exchanger can be calculated. To do so, consumption calculation must be activated (EXCHER CAP ON) and the parameters of the ion exchanger (size, capacity, efficiency) must be entered. Depletion of the ion exchanger is signaled by the "wrench" maintenance icon and the "ERR 111 WARNING CATION EXCHANGER CAPACITY" message or the "ERR 110 CATION EXCHANGER CAPACITY" message (with 0 %).</p> <p>When you have replaced the ion exchanger, you must select NEW EXCHANGER YES to restart the calculation.</p> <p>You can also do this directly from within measuring mode; see page 68.</p>
	
	<p>Specifying the current at outputs 1 and 2: Select OUT1 or OUT2 using the ◀ ▶ keys, press enter to confirm. Enter a valid current value for the respective output using ▲ ▼ ◀ ▶ keys. Press enter to confirm.</p> <p>For checking purposes, the actual output current is shown in the bottom right corner of the display. End by pressing enter or meas.</p>

Service

Menu item	Remark
 The LCD display shows four zeros '0000' at the top. Below them are two options: 'DIAG' on the left and 'HOLD' on the right. There are also some icons at the top right, including a triangle with 'HOLD' and a small 'i'.	<p>Assigning passcodes: In the "SERVICE - CODES" menu you can assign passcodes to DIAG, HOLD, CAL, CONF and SERVICE modes (Service preset to 5555).</p> <p>When you have lost the Service passcode, you have to request an "Ambulance TAN" from the manufacturer specifying the serial number of your device. To enter the "Ambulance TAN", call the Service function and enter passcode 7321. After correct input of the ambulance TAN the device signals "PASS" for 4 sec and resets the Service passcode to 5555.</p>
 The LCD display shows 'FACTORY SETTING' at the bottom and 'NO' in the middle. There are also some icons at the top right, including a triangle with 'HOLD' and a small 'i'.	<p>Reset to factory settings: In the "SERVICE - DEFAULT" menu you can reset the device to factory settings.</p> <p>NOTICE After a reset to factory setting the device must be reconfigured completely, including the sensor parameters!</p>
 The LCD display shows four zeros '0000' at the top. Below them are two options: 'OPT: LOGBOOK' on the left and 'TAN' on the right. There are also some icons at the top right, including a triangle with 'HOLD' and a small 'i'.	<p>Option request: Communicate the serial number and hardware/software version of your device to the manufacturer. These data can be viewed in the Diagnostics/Version menu. The "transaction number" (TAN) you will then receive is only valid for the device with the corresponding serial number.</p> <p>Releasing an option: Options come with a "transaction number" (TAN). To release the option, enter this TAN and confirm by pressing enter.</p>

Operating States

Operating status	OUT 1	OUT 2	time out
Measuring			-
Diag			60 s
CAL_CELL_A Cell factor			No
CAL_CELL_B Cell factor			No
HOLD input			No
CONF			20 min
SERVICE			20 min

Explanation:



as configured (Last/Fix)



active

Supply Units and Connection

Recommended Power Supply Units: **Order No.:**

Repeater power supply, non-Ex, 24 V DC, IsoAmp PWR B 10116
output 4...20 mA

Repeater power supply, non-Ex, 24 V DC, IsoAmp PWR A 20100
HART, output 0/4...20 mA / 0...10 V

Connection to Supply Units

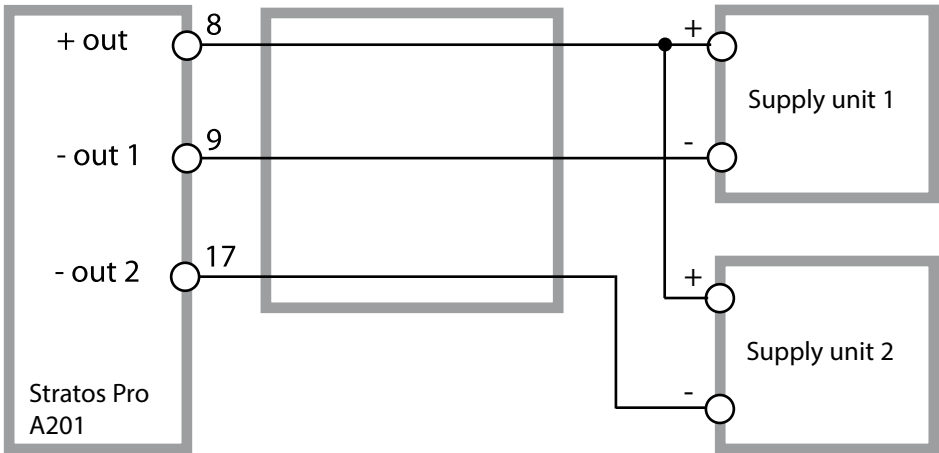

Product Line and Accessories

Order Code Stratos Pro A201

Example	A	2	0	1	N	-	CC	-	1	TAN
2-wire / 4-20 mA	A	2								B,C,E
Communication										
Without (HART retrofittable via TAN)			0							A
Version number										
Version				1						
Approvals										
General Safety					N					
ATEX / IECEx Zone 2					B					
ATEX / IECEx / FM / CSA Zone 1 / CI 1 Div 1					X					
Measuring channel										
Memosens pH / Redox	digital						MSPH			G
Memosens Cond	digital						MSCOND			
Memosens Condi	digital						MSCONDI			
Memosens Oxy	digital						MSOXY			
Dual COND (2x2-electrode sensors, analog)					N		CC			
pH / ORP value (ISM digital per TAN)	Measuring module						PH			F, G
Cond, 2-/4-electrode	Measuring module						COND			
Conductivity, electrodeless	Measuring module						CONDI			
Oxygen (ISM digital and traces per TAN)	Measuring module						OXY			D, F
Options										
Without 2nd current output									0	
With 2nd current output									1	
TAN options										
HART							SW-A001			(A)
Logbook							SW-A002			(B)
Extended logbook (Audit Trail)							SW-A003			(C)
Trace oxygen measurement							SW-A004			(D)
Current input + 2 digital inputs							SW-A005			(E)
ISM digital							SW-A006			(F)
Pfudler							SW-A007			(G)
Mounting accessories										
Pipe-mount kit							ZU 0274			
Protective hood							ZU 0737			
Panel-mount kit							ZU 0738			

Specifications

COND inputs A/B	2 inputs for 2-electrode sensors	
Measuring range	2-el. sensors	0 ... 30,000 $\mu\text{S} \cdot \text{cm}$
Display ranges	Conductivity	0.000 ... 9.999 $\mu\text{S}/\text{cm}$
		00.00 ... 99.99 $\mu\text{S}/\text{cm}$
		000.0 ... 999.9 $\mu\text{S}/\text{cm}$
		0000 ... 9999 $\mu\text{S}/\text{cm}$
	Resistivity	00.00 ... 99.99 $\text{M}\Omega \cdot \text{cm}$
Response time (T90)	Approx. 1 s	
Measurement error ^{1,2,3)}	< 1 % meas. val. + 0.4 $\mu\text{S} \cdot \text{cm}$	
Temp compensation * (reference temp +25 °C / +77 °F)	(OFF)	Without
	(LIN)	Linear characteristic 00.00 ... 19.99 %/K
	(NLF)	Natural waters to EN 27888
	(NACL)	Ultrapure water with NaCl traces (0 ... +120 °C / +32 ... +248 °F)
	(HCL)	Ultrapure water with HCl traces (0 ... +120 °C / +32 ... +248 °F)
	(NH3)	Ultrapure water with NH ₃ traces (0 ... +120 °C / +32 ... +248 °F)
	(NaOH)	Ultrapure water with NaOH traces (0 ... +120 °C / +32 ... +248 °F)
Calculations (CALC)	-C1- Difference	A – B [μS/cm]
	-C2- Ratio	A / B 00.00 ... 19.99
	-C3- Passage	B / A * 100 000.0 ... 199.9 %
	-C4- Rejection	(A – B) / A * 100 -199.9 ... 199.9 %
	-C5- Deviation	(B – A) / A * 100 -199.9 ... 199.9 %
	-C6- pH value	Acc. to directive VGB S-006 [pH]
	-C7- pH value	Variable, specifiable factors [pH]
	-C8- USER SPEC	DAC (Degassed Acid Conductivity) [μS/cm]
	-C9- ALKALISING	Concentration of the alkalinizing agent (VGB S-006)
Sensor standardization channel A / B	Input of cell factor with simultaneous display of conductivity and temperature	
Permissible cell factor	0.0050 ... 1.9999 cm^{-1}	
Sensocheck	Polarization detection and monitoring of cable capacitance	
Delay	Approx. 30 s	
Sensoface	Provides information on the sensor condition, Sensocheck, flow monitoring	

Sensor monitor	Direct display of measured values from sensor for validation resistance / conductance / temperature
Temperature input A/B ^{*)}	Pt1000, 2-wire connection
Measuring range	-50 ... +200 °C / -58 ... +392 °F
Resolution	0.1 °C / 0.1 °F
Measurement error ^{1,2,3)}	0.5 K (1 K > 100 °C)
I input (TAN)	Current input 0/4 ... 20 mA / 50 Ω for flow monitoring
Characteristic	Linear
Measurement error ^{1,3)}	< 1% current value + 0.1 mA
HOLD input (TAN)	Galvanically separated (optocoupler)
Function	Switches device to HOLD mode
Switching voltage	0 ... 2 V AC/DC HOLD inactive 10 ... 30 V AC/DC HOLD active
CONTROL input (TAN)	Galvanically separated (optocoupler), either for LEVEL or FLOW
LEVEL function	Relay input for external monitoring equipment
FLOW function	Pulse input for flow measurement 0 ... 100 pulses/s
Function	Input for external monitoring equipment, e.g. flow
Switching voltage	0 ... 2 V AC/DC Inactive 10 ... 30 V AC/DC Active
Display	Message via 22 mA 00.0 ... 99.9 l/h
Output 1	Current loop, 4 ... 20 mA, floating, protected against inverse polarity HART communication (see further below for specifications)
Supply voltage	14 ... 30 V
Process variable *	Conductivity A/B, resistivity A/B, temperature A/B or CALC
Characteristic	linear, bilinear
Overrange *	22 mA in the case of error messages
Output filter *	PT ₁ filter, time constant 0 ... 120 s
Measurement error ¹⁾	< 0.25 % current value + 0.025 mA
Start/end of scale *	Configurable within selected range
Bilinear: Vertex X/Y *	Configurable within selected range

Specifications

Output 2

Supply voltage

Process variable *

Characteristic

Overrange *

Output filter *

Measurement error ¹⁾

Start/end of scale †

Bilinear: Vertex X/Y *

Current loop 4 ... 20 mA, floating, protected against inverse polarity

14 ... 30 V

Conductivity A/B, resistivity A/B, temperature A/B, or CALC

linear, bilinear

22 mA in the case of error messages

PT, filter, time constant 0 ... 120 s

< 0.25 % of current value + 0.05 mA

Configurable within selected range

Configurable within selected range

Real-time clock

Power reserve

Different time and date formats selectable

> 5 days

Display

Main display

Secondary display

Text line

Sensoface

Mode Indicators

Alarm indication

LC display, 7-segment with icons

Character height approx. 22 mm, unit symbols approx. 14 mm

Character height approx. 10 mm

14 characters, 14 segments

3 status indicators (friendly, neutral, sad face)

meas, cal, conf, diag

Further icons for configuration and messages

Display blinks, red backlighting

Keypad

Keys: meas, menu, info, 4 cursor keys, enter

HART communication

HART version 6

Digital communication by FSK modulation of output current 1

Device identification, measured values, status and messages, parameter setting, calibration, records

FDA 21 CFR Part 11

Access control by editable passcodes

Logbook entry and flag via HART in the case of configuration changes

Message and logbook entry when enclosure is opened

Diagnostics functions

Calibration data

Device self-test

Logbook (TAN)

Extended logbook (TAN)

Calibration date, cell factor

Display test, automatic memory test (RAM, FLASH, EEPROM)

100 events with date and time

Audit Trail: 200 events with date and time

Service functions

Sensor monitor

Current source

Passcodes

Factory setting

TAN

Display of direct, uncorrected sensor signals

Current specifiable for output 1 and 2 (03.80 ... 22.00 mA)

Assigning passcodes for menu access

Resetting all parameters to factory setting

Enabling optionally available additional functions

Data retention	Parameters, calibration data, logbook > 10 years (EEPROM)
Housing	Molded enclosure, glass fiber reinforced Front unit material: PBT Rear unit material: PC
Mounting	Wall, pipe/post or panel mounting
Color	Gray RAL 7001
Ingress protection	IP66/IP67/TYP E 4X outdoor (with pressure compensation) when the device is closed
Flammability	UL 94 V-0 for external parts
Dimensions	148 mm x 148 mm
Control panel cutout	138 mm x 138 mm acc. to DIN 43 700
Weight	approx. 1200 kg (1.6 kg incl. accessories and packaging)
Cable glands	5 knockouts for M20 x 1.5 cable glands 2 of 5 knockouts for NPT ½" or rigid metallic conduit
Terminals	
Screw terminals	for single or stranded wires 0.2... 2.5 mm ²
Tightening torque	0.5 ... 0.6 Nm
Wiring	
Stripping length	Max. 7 mm
Temperature resistance	> 75 °C / 167 °F
Rated operating conditions	
Climatic class	3K5 according to EN 60721-3-3
Location class	C1 according to EN 60654-1
Ambient temperature	-20 ... 65 °C / -4 ... 149 °F
Relative humidity	5 ... 95 %
Supply voltage	14 ... 30 V
Transport and storage	
Transport / storage temperature	-30 ... 70 °C / -22 ... 158 °F
EMC	
Emitted interference	Class A (industrial applications) ⁴⁾
Immunity to interference	Industrial applications

*) User-defined

1) At rated operating conditions

2) ± 1 digit

3) Plus sensor error

4) This equipment is not designed for domestic use, and is unable to guarantee adequate protection of the radio reception in such environments.

Error Handling

Alarm condition:

- The display backlighting turns **red**
- The alarm icon  is displayed
- The complete measured-value display blinks
- “**ERR xxx**” is displayed in the lower menu line

Press the [**info**] key to view a short error text:

- The error text appears in the lower menu line
- The main display reads “**InFo**”.

Parameter errors:

Configuration data such as current range, limit values, etc are checked during the input.

If they are out of range,

- “**ERR xxx**” is displayed for 3 sec,
- the display backlighting flashes red,
- the respective maximum or minimum value is shown,
- input must be repeated.

If a faulty parameter arrives through the interface (HART),

- an error message will be displayed: “**ERR 100...199**”
- the faulty parameter can be localized by pressing the [**info**] key

Calibration errors:

If errors occur during calibration,

- an error message will be displayed

Sensoface:

If the Sensoface becomes sad,

- the display backlighting will turn magenta (purple)
- the cause can be seen by pressing the **info** key
- the calibration data can be seen in the Diagnostics menu

Error Messages

Error	Info text (is displayed in case of fault when the Info key is pressed)	Problem Possible causes
ERR 10 (Channel A) ERR 40 (Channel B)	CONDUCTANCE TOO HIGH	Conductance value out of range: > 250 mS
ERR 11 (Channel A) ERR 41 (Channel B)	CONDUCTIVITY RANGE	Display range violation Cond > 9999 μ S/cm < 0.1 k Ω cm
ERR 13 (Channel A) ERR 43 (Channel B)	TEMPERATURE RANGE	Temperature range limits exceeded Connect the sensor, check the sensor cable and replace if necessary, check the sensor connection, adjust the parameter settings.
ERR 15 (Channel A) ERR 45 (Channel B)	SENSOCHECK	Sensocheck Check the cable
ERR 59	INVALID CALCULATION	pH value cannot be calculated. Difference between the measured conductivity values value is too large.
ERR 60	OUTPUT LOAD	Load error Check the current loop, deactivate unused current outputs.
ERR 61	OUTPUT 1 TOO LOW	Output current 1 > 3.8 mA
ERR 62	OUTPUT 1 TOO HIGH	Output current 1 > 20.5 mA
ERR 63	OUTPUT 2 TOO LOW	Output current 2 > 3.8 mA
ERR 64	OUTPUT 2 TOO HIGH	Output current 2 > 20.5 mA
ERR 71	I-INPUT	Current input limit value
ERR 72	FLOW TOO LOW	Flow too low
ERR 73	FLOW TOO HIGH	Flow too high

Error Messages

Error	Info text (is displayed in case of fault when the Info key is pressed)	Problem Possible causes
ERR 74	CATION EXCHANGER INVALID CALCULATION	Flow too low or no flow: Flow ≤ 4.00 l/h; calculated pH value: < 7.5 or > 10.5 ; conductivity values: $B \geq 3 \times A$
ERR 95	SYSTEM ERROR	System error Restart required. If error still persists, send in the device for repair.
ERR 96	WRONG MODULE	Wrong module Please have the module replaced at the factory.
ERR 97	NO MODULE INSTALLED	Supply voltage too low or no module installed
ERR 98	CONFIGURATION ERROR	Error in configuration or calibration data Memory error in device program Configuration or calibration data defective; completely reconfigure and recalibrate the device.
ERR 99	DEVICE FAILURE	Error in factory settings EEPROM or RAM defective This error message only occurs in the case of a total defect. The device must be repaired and recalibrated at the factory.
ERR 105	INVALID SPAN I-INPUT	I-Input configuration error
ERR 106	INVALID CHANNEL SELECTION	Configuration error
ERR 108	OUT1 INVALID CORNER X/Y	OUT1 bilinear, wrong characteristic
ERR 109	OUT2 INVALID CORNER X/Y	OUT2 bilinear, wrong characteristic
ERR 110	CATION EXCHANGER CAPACITY	Capacity of ion exchanger used up – replace
ERR 111	WARNING CATION EXCHANGER CAPACITY	Capacity of ion exchanger almost used up – replace soon.

Disposal

Local codes and regulations must be observed when disposing of the product.

Returns

If required, send the product in a clean condition and securely packed to your local contact. See www.knick.de.

Sensocheck and Sensoface

(Sensocheck must have been activated during configuration.)

The smiley in the display (Sensoface) alerts to sensor problems (defective sensor, defective cable, maintenance required).

The permissible calibration ranges and the conditions for a friendly, neutral, or sad Sensoface are summarized in the following table. Additional icons refer to the error cause.

Note:

The worsening of a Sensoface criterion leads to the devaluation of the Sensoface indicator (Smiley becomes “sad”). An improvement of the Sensoface indicator can only take place after calibration or removal of the sensor defect.

Sensocheck

Continuously monitors the sensor polarization and the sensor cable capacitance. Critical values make the Sensoface “sad” and the corresponding icon blinks:









The Sensocheck message is also output as error message Err 15.

The display backlighting turns red, output current 1 is set to 22 mA (when configured correspondingly).

Sensocheck can be switched off during configuration (then Sensoface is also disabled).

Exception:

After a calibration a smiley is always displayed for confirmation.

Display	Problem	Status
	Sensor defect	 Wrong or defective sensor, significant polarization of sensor or excessive cable capacitance (see also error message Err 15).
	Temperature	 Temperature outside measuring ranges
	Cell factor channel A, B	 Cell factor $< 0.005 \text{ cm}^{-1}$ or cell factor $> 1.9999 \text{ cm}^{-1}$

HART: Typical Applications

(SW-A001)

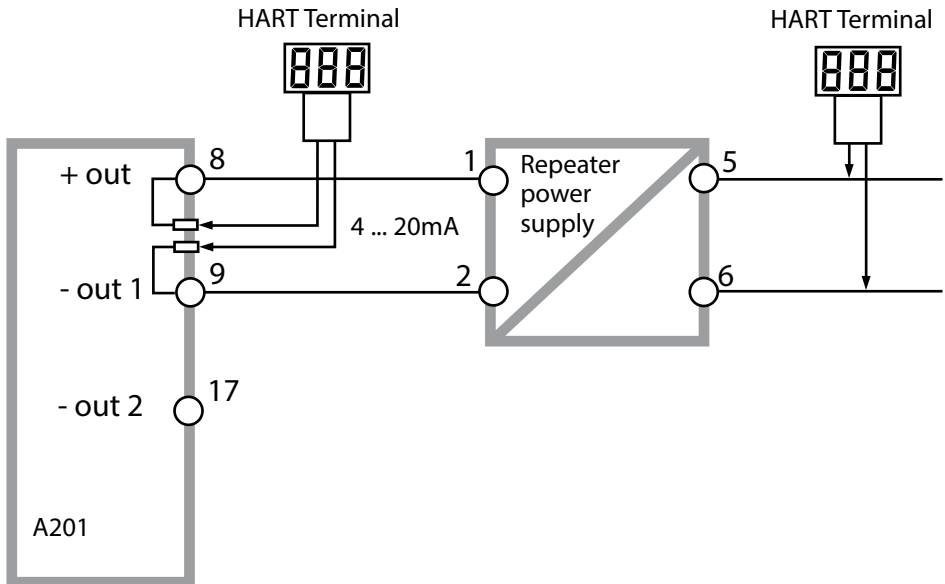
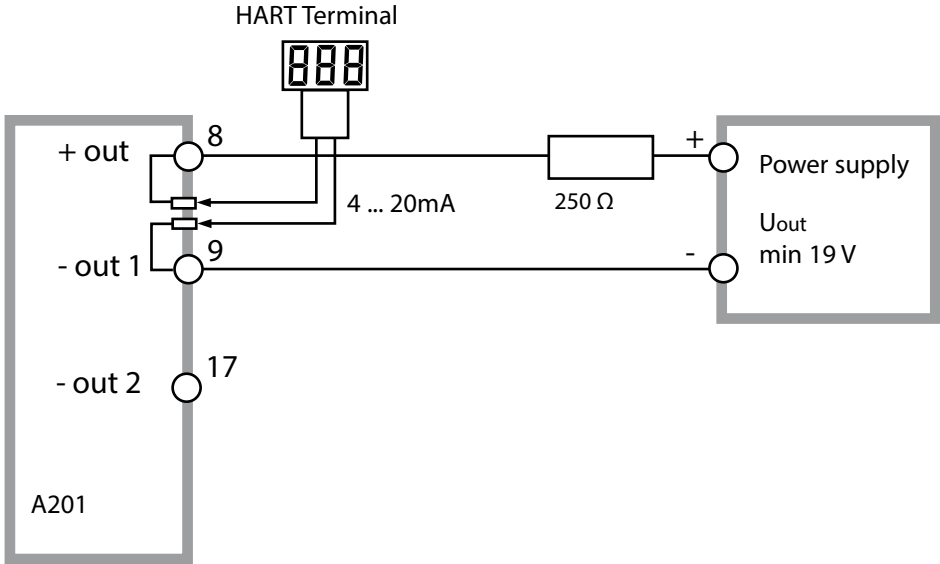

Conformity with FDA 21 CFR Part 11

In their directive “Title 21 Code of Federal Regulations, 21 CFR Part 11, Electronic Records; Electronic Signatures” the American health agency FDA (Food and Drug Administration) regulates the production and processing of electronic documents for pharmaceutical development and production. This results in requirements for measuring devices used for corresponding applications. The following features ensure that the measuring devices of this Series meet the demands of FDA 21 CFR Part 11:

Electronic Signature – Passcodes

Access to the device functions is regulated and limited by individually adjustable codes – “Passcodes” (see SERVICE). This prevents unauthorized modification of device settings or manipulation of the measurement results. Appropriate use of these passcodes makes them suitable as electronic signature.

Audit Trail

Every (manual) change of device settings can be automatically documented. Each change is tagged with a “Configuration Change Flag”, which can be interrogated and documented using HART communication. Altered device settings or parameters can also be retrieved and documented using HART communication.

Extended logbook (TAN SW-A003)

Audit Trail also records function activations (CAL, CONFIG, SERVICE), some Sensoface messages (cal timer, wear, SIP, CIP) and opening of the enclosure.

Index

A

Access code assignment 76
Accessories 79
Activating an option 76
Adjustable ranges, current outputs 41
Adjustable ranges, relay contacts 41
Alarm 30
Alarm and HOLD messages 31
Alarm settings 60
Ambulance TAN 76
Assembly 11
Audit Trail 91
Audit Trail, diagnostics 72
Autorange 49

B

Backlighting 22
Bilinear curve 51

C

Cable glands 15
Calculation of output parameters 46
Calculations (CALC) 34
Calibration 66
Calibration by input of cell factor 67
Calibration data 70
Calibration errors 84
Calibration, general 27
Cation exchanger, calculations 34
Cation exchanger replacement 75
Channel selection and display assignment (CC) 33
Commissioning 6
Configuration, alarm 60
Configuration (Cond-Cond) 37
Configuration (Cond-Cond), overview 37
Configuration, CONTROL input 58
Configuration, current output 1 48
Configuration, current output 2 56
Configuration, display backlighting 64
Configuration, general 27
Configuration, measuring point 64
Configuration, menu structure 32

- Configuration, sensor 44
- Configuration, time and date 62
- Connection length for sensors, maximum (CC) 33
- Connection to supply units 78
- Consumption calculation of ion exchanger 34
- Consumption calculation, reset 75
- CONTROL, alarm settings 61
- CONTROL, configuring the input 58
- CONTROL input 31
- Control inputs 9
- Current input 31
- Current outputs, adjustable ranges 41
- Current start/end 49

D

- Data logger, explanation 9
- Date and time (configuration) 62
- Date and time (usage) 63
- Date, display 68
- Decommissioning 87
- Device self-test 71
- Device type, display 73
- Diagnostics, calibration data 70
- Diagnostics, device self-test 71
- Diagnostics, general 27
- Diagnostics, logbook 72
- Diagnostics mode 69
- Diagnostics, sensor monitor 72
- Diagnostics, version 73
- Dimensions 12
- Display 22
- Display colors 22
- Display test 71
- Disposal 87
- Documentation: package contents 3
- Dual conductivity measurement, calculations (CALC) 34
- Dual conductivity measurement, pH value calculation 36

E

EEPROM test 71
Electrical installation 15
Electronic Signature 91
Enabling an option 76
Enclosure 12
Enclosure components 11
Entering values 24
Error handling 84
Error messages 85
Extended logbook, Audit Trail 91
Extended logbook, diagnostics 72

F

FDA 21 CFR Part 11 91
FLASH test 71
FLOW 59
Flow measurement 58

H

HART, typical applications 90
HOLD mode, description 29
HOLD mode, external activation 30
HOLD mode, manual activation 30
HOLD mode, output signal 29
HOLD mode, terminating 29
HOLD, output signal during HOLD 55

I

Info text 85
Installation, notices 15
Intended use 6
Ion exchanger, calculations 34
Ion exchanger consumption, measured value display 68
Ion exchanger replacement 75
Ion exchanger replacement, measuring mode 68

K

Keypad 21

L

Level, flow measurement 59
LIMIT I-IN 31
Logbook, diagnostics 72

M

- Measurement, general 23
- Measuring mode 68
- Measuring point, arrangement (CC) 33
- Measuring point (TAG) 65
- Measuring range, configuration 46
- Menu structure of configuration 32
- Message via CONTROL input 31
- Message via current input 31
- Module test 71
- Monitoring function of ion exchanger 41
- Mounting options 8
- Mounting plan 12

O

- Operating modes 27
- Operating mode, selection 24
- Operating states 77
- Option request 76
- Option request, requirements 73
- Options, overview 79
- Order code 79
- Output current curve 50
- Output current, specify value 75
- Output filter 52
- Output signal during HOLD 29, 55
- Overview 10
- Overview, device properties 8

P

- Package contents 11
- Package contents: documentation 3
- Panel mounting 14
- Parameter error 84
- pH value calculation 36
- Pipe mounting 13
- Point of measurement, arrangement (CC) 33
- Power supply units 78
- Product line 79
- Protective hood 13

Q

- Quickstart guides 3

R

- RAM test 71
- Rated operating conditions 83
- Rating plates 16
- Remaining capacity of ion exchanger 73
- Reset to factory settings 76
- Returns 87

S

- Safety 6
- Safety guide 3
- Selection menu 24
- Sensocheck, configuration 61
- Sensocheck, description 88
- Sensoface, description 88
- Sensoface, troubleshooting 84
- Sensor connection 17
- Sensor monitor, diagnostics 72
- Sensor monitor (Service) 75
- Serial number, display 73
- Service 74
- Service, factory setting 76
- Service, general 27
- Service, output current, specify value 75
- Service, passcode assignment 76
- Service passcode lost 76
- Service, sensor monitor 75
- Setting the passcodes 76
- Signal colors 22
- Signal outputs 9
- Software/hardware version, display 73
- Software version of HART interface, display 73
- Specifications 80
- Supplemental directives 2
- Supply units 78

T

- TAN input 76
- TAN options, activation 76
- TAN options, overview 79
- Technical data 80
- Terminal assignments 16
- Test report 2.2 3
- Time and date (configuration) 62
- Time and date (usage) 63
- Time averaging filter 53
- Time, display 68
- Transaction number (TAN) 76

U

- User interface 21

W

- Weather protector 13
- Wiring 17
- Wiring examples 18
- Wiring, power supply units 78



Knick
Elektronische Messgeräte
GmbH & Co. KG

Headquarters

Beuckestraße 22 • 14163 Berlin

Germany

Phone: +49 30 80191-0

Fax: +49 30 80191-200

info@knick.de

www.knick.de

Local Contacts

www.knick-international.com

Translation of the original instructions

Copyright 2022 • Subject to change

Version: 4 • This document was published on August 17, 2022.

The latest documents are available for download on our website under the corresponding product description.



099497

TA-212.165-KNEN04