

Subject to change without notice.

Return of Products Under Warranty

Please contact our Service Team before returning a defective device. Ship the cleaned device to the address you have been given. If the device has been in contact with process fluids, it must be decontaminated/disinfected before shipment. In that case, please attach a corresponding certificate, for the health and safety of our service personnel.

Disposal

Please observe the applicable local or national regulations concerning the disposal of "waste electrical and electronic equipment".

Knick

Elektronische Messgeräte GmbH & Co. KG

Beuckestraße 22

14163 Berlin

Germany

Phone: +49 30 80191-0

Fax: +49 30 80191-200

Web: www.knick.de

Email: info@knick.de

Table of Contents

Safety Information	5
Intended Use.....	7
Registered Trademarks.....	7
Provided Documentation	8
Overview of Stratos Eco 2405 pH.....	9
Assembly	10
Package Contents.....	10
Mounting Plan.....	11
Pipe Mounting, Panel Mounting.....	12
Installation and Connection.....	14
Installation Instructions	14
Terminal Assignments	14
VP Cable Connection	16
VP Cable Assignment.....	17
pH Wiring Examples	18
ORP Wiring Example.....	21
Protective Wiring of Relay Outputs	22
User Interface and Display	24
Operation: Keypad	26
Safety Functions	27
Sensocheck, Sensoface Sensor Monitoring.....	27
GainCheck Device Self-Test.....	27
Automatic Device Self-Test.....	27
Hold Mode	28
Configuration	30
Menu Structure of Configuration	31
Overview of Configuration Steps	32
Output 1	34
Output 2	42
Temperature Compensation	48
Calibration Mode.....	50
Alarm Settings.....	52

Table of Contents

Limit Function.....	54
Controlling a Rinsing Probe.....	56
Connecting a Rinsing System	57
Parameters.....	58
Factory Settings of Parameters	58
Parameters – Individual Settings.....	60
Calibration	62
pH Calibration.....	63
Automatic Calibration with Calimatic (BUF -xx-)	64
Manual Calibration	66
Data Entry of Premeasured Electrodes	68
Product Calibration	69
ORP Calibration	70
Temp Probe Adjustment	72
Measurement	72
Diagnostics Functions	73
Error Messages (Error Codes).....	75
Calibration Error Messages	77
Operating States.....	79
Sensoface	80
Appendix.....	83
Product Line and Accessories.....	83
Specifications.....	84
Buffer Tables	90
Glossary.....	98
Safe Operation.....	101
Index	103
Passcodes	107

Safety information –

Be sure to read and observe the following instructions!

The device has been manufactured using state of the art technology and it complies with applicable safety regulations.

When operating the device, certain conditions may nevertheless lead to danger for the operator or damage to the device.

CAUTION!

Commissioning must be carried out by trained experts.

Whenever it is likely that protection has been impaired, the device shall be made inoperative and secured against unintended operation.

The protection is likely to be impaired if, for example:

- the device shows visible damage
- the device fails to perform the intended measurements
- after prolonged storage at temperatures above 70°C / 158 °F
- after severe transport stresses

Before recommissioning the device, a professional routine test in accordance with EN 61010-1 must be performed. This test should be carried out at the manufacturer's factory.

CAUTION!

Before commissioning, make sure that the transmitter may be connected with the other equipment.

Intended Use

The Stratos Eco 2405 pH is used for pH/mV, ORP, and temperature measurement in industry, environment, food processing, and sewage treatment.

The sturdy molded enclosure can be fixed into a control panel or mounted on a wall or at a post.

The protective hood provides additional protection against direct weather exposure and mechanical damage.

The device has been designed for application with commercially available sensors with a nominal zero point at pH 7. It provides two current outputs (for transmission of measured value and temperature, for example), two contacts, and a universal power supply 24 ... 230 V AC/DC, AC: 45 ... 65 Hz.

Registered Trademarks

The following names are registered trademarks. For practical reasons they are shown without trademark symbol in this manual.

Stratos®

Sensocheck®

Sensoface®

Calimatic®

GainCheck®

Provided Documentation

Safety Instructions

In official EU languages and others.

Quickstart Guides

In German, English, French, Russian, Finnish, Swedish, Spanish, Portuguese, and Chinese.

- Installation and Commissioning
- Operation
- Menu structure
- Calibration
- Error messages and recommended actions

Test Report 2.2

according to EN 10204

Overview of Stratos Eco 2405 pH

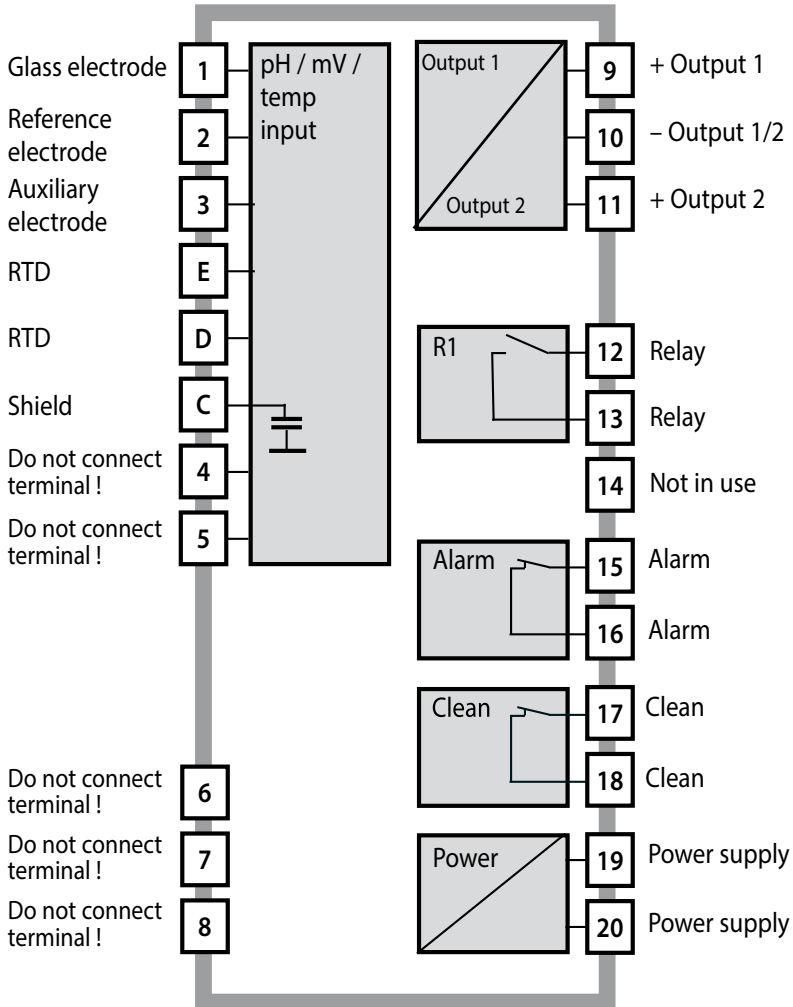

Assembly

Package Contents

Check the shipment for transport damage and completeness.
The package should contain:

- Front unit
- Rear unit
- Bag containing small parts
- Documentation
- Passcode sticker

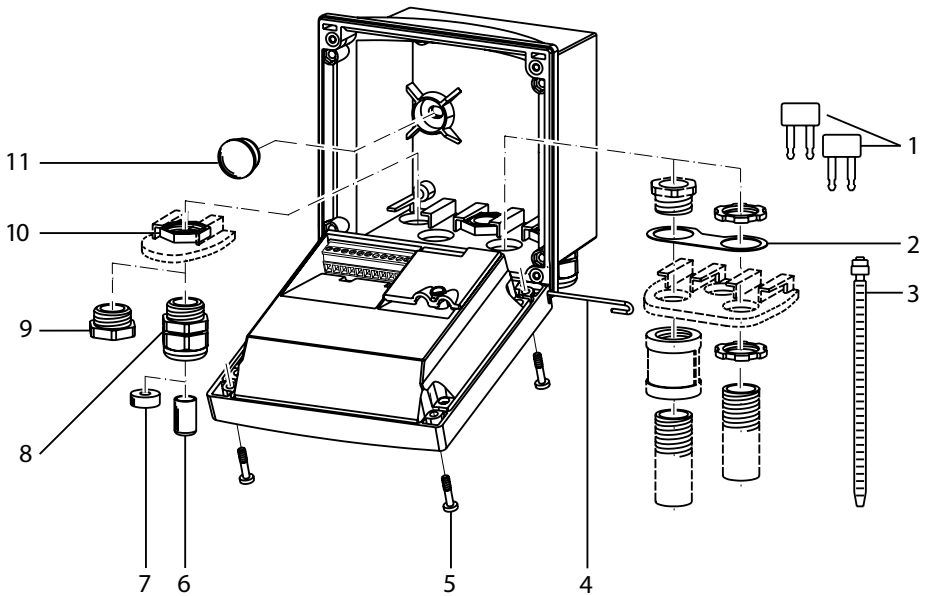

- | | |
|---|---|
| 1 Jumper (2 x) | 6 Sealing insert (1 x) |
| 2 Washer (1 x), for conduit mounting:
Place washer between enclosure and nut | 7 Rubber reducer (1 x) |
| 3 Cable tie (3 x) | 8 Cable gland (3 x) |
| 4 Hinge pin (1 x), insertable from either side | 9 Filler plug (3 x) |
| 5 Enclosure screw (4 x) | 10 Hexagon nut (5 x) |
| | 11 Sealing plug (2 x), for sealing in case of wall mounting |

Fig.: Assembling the enclosure

Mounting Plan

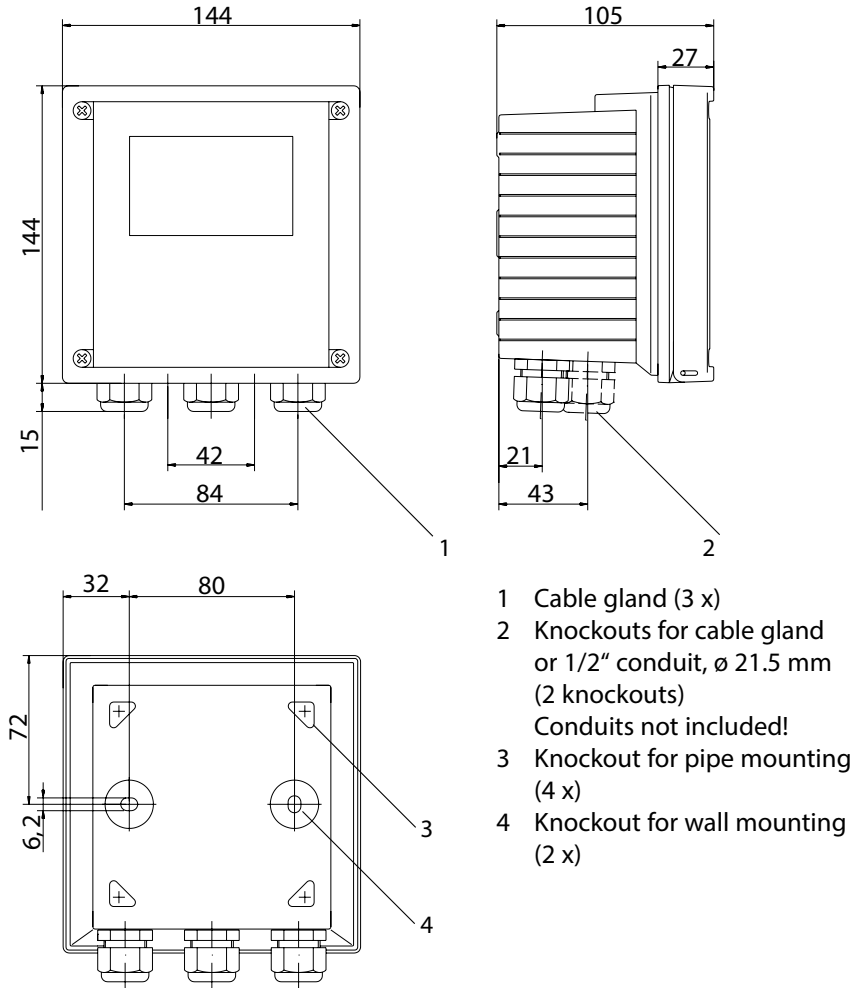
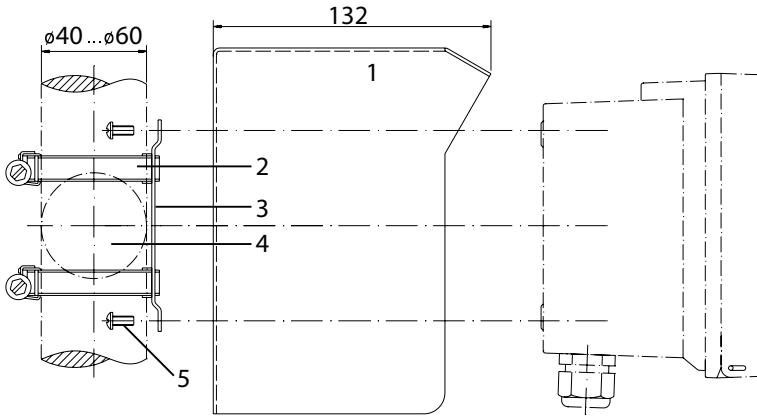

Fig.: Mounting plan (All dimensions in mm!)

Pipe Mounting, Panel Mounting



- 1 ZU 0276 protective hood (if required)
- 2 Hose clamp with worm gear drive to DIN 3017 (2 x)
- 3 Pipe-mount plate (1 x)
- 4 For vertical or horizontal posts or pipes
- 5 Self-tapping screw (4 x)

Fig.: ZU 0274 pipe-mount kit (All dimensions in mm!)

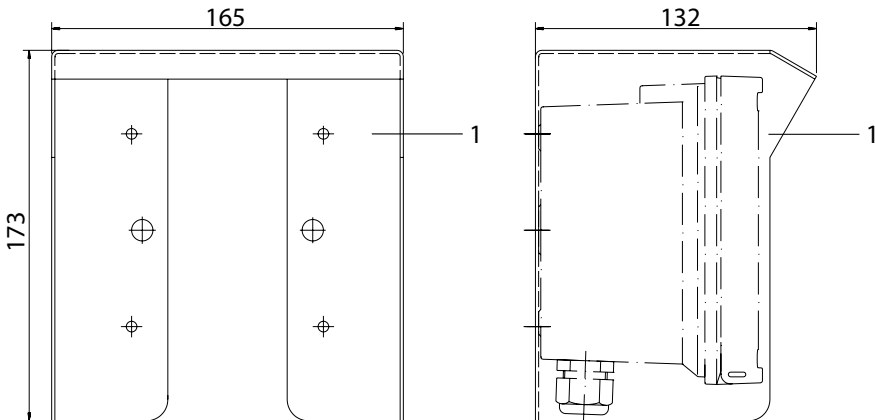
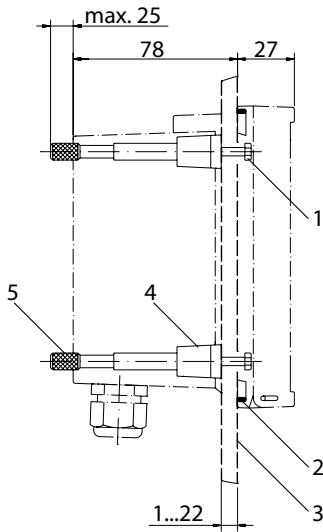

Fig.: ZU 0276 protective hood for wall and pipe mounting
(All dimensions in mm!)



- 1 Screw (4 x)
- 2 Gasket (1 x)
- 3 Control panel
- 4 Span piece (4 x)
- 5 Threaded sleeve (4 x)

Panel cut-out
138 x 138 mm (DIN 43700)

Fig.: ZU 0275 panel-mount kit (All dimensions in mm!)

Installation and Connection

Installation Instructions

CAUTION!

- Installation of the Stratos must be carried out by trained experts in accordance with this instruction manual and as per applicable local and national codes.
- Be sure to observe the technical specifications and input ratings during installation.
- Be sure not to notch the conductor when stripping the insulation.
- Before connecting the device to the power supply, make sure that its voltage lies within the range 20.5 ... 253 V AC/DC.
- All parameters must be set by a system administrator prior to commissioning.

The terminals are suitable for single wires and flexible leads up to 2.5 mm² (AWG 14).

Terminal Assignments

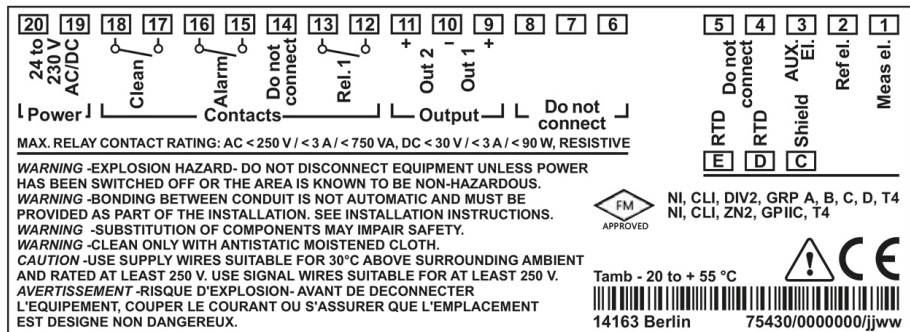
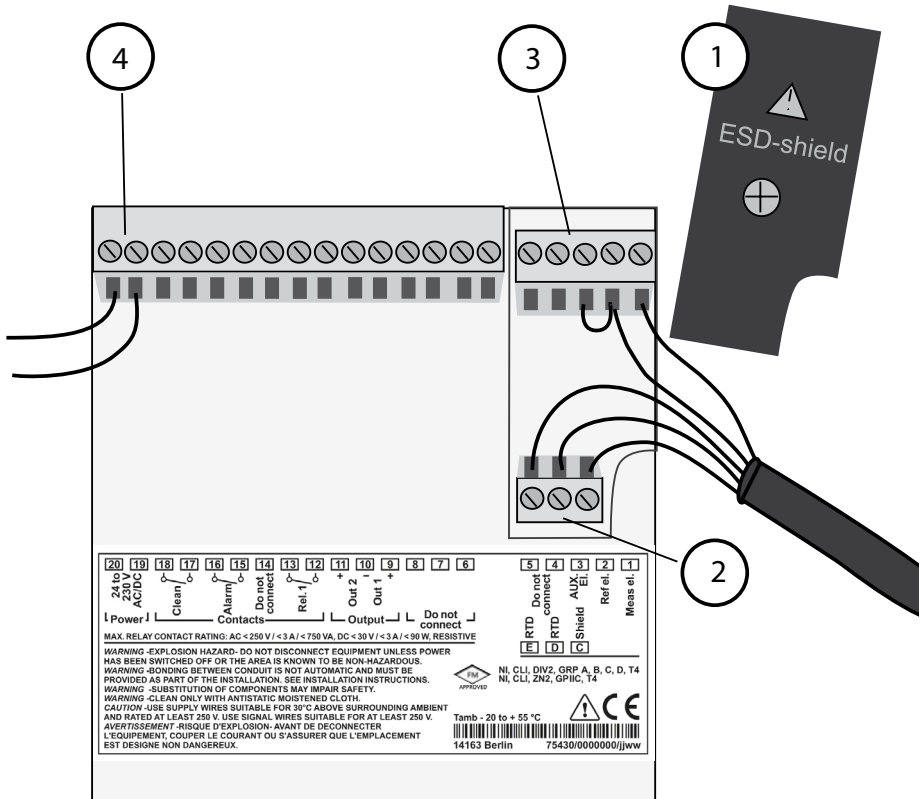

Fig.: Stratos Eco 2405 pH terminal assignments

Installation and Connection



- 1 ESD shield covering the signal inputs (Screw off for assembly)
Note: The cable shield must end under the ESD shield.
(Cut lines if required.)
- 2 Terminals for temperature probe and outer shield
- 3 Terminals for sensor
- 4 Power supply connection

Fig.: Information on installation, rear side of device

Division 2 Wiring



The connections to the device must be installed in accordance with the National Electric Code (ANSI NFPA 70) Division 2 hazardous (classified) location non-incendive wiring techniques.

Installation and Connection

VP Cable Connection

Connecting the sensor to the VP cable

ZU 0313: 3 m
ZU 0314: 5 m
ZU 0315: 10 m

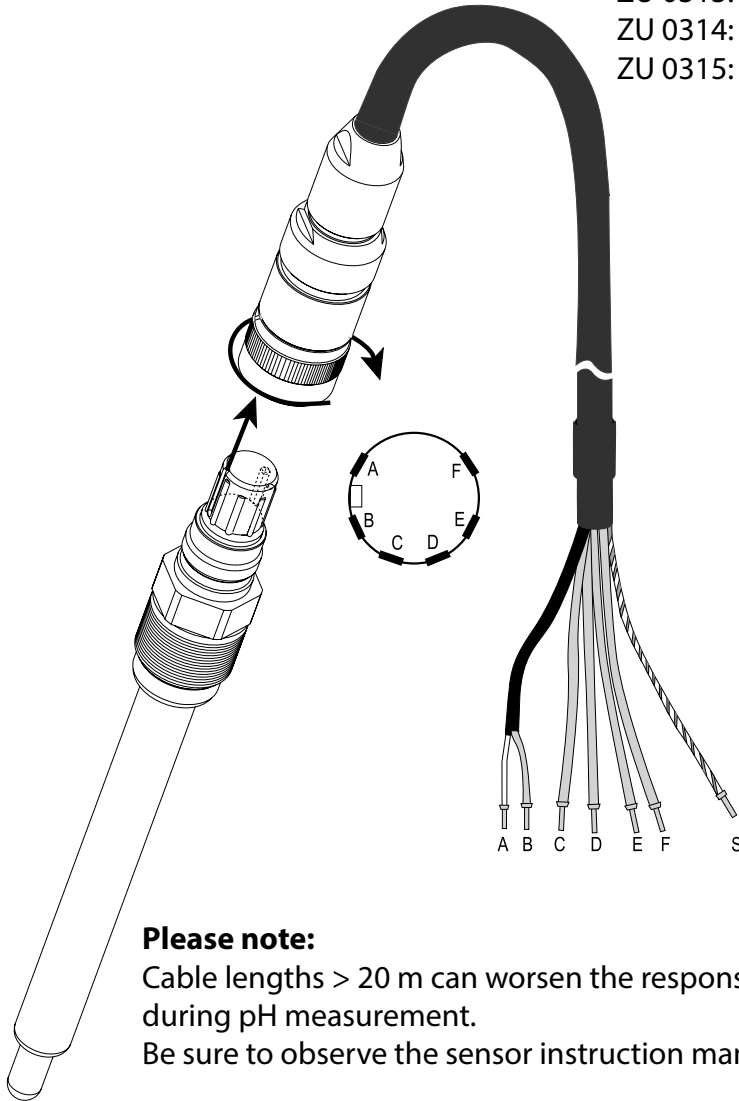

VP Cable Assignment

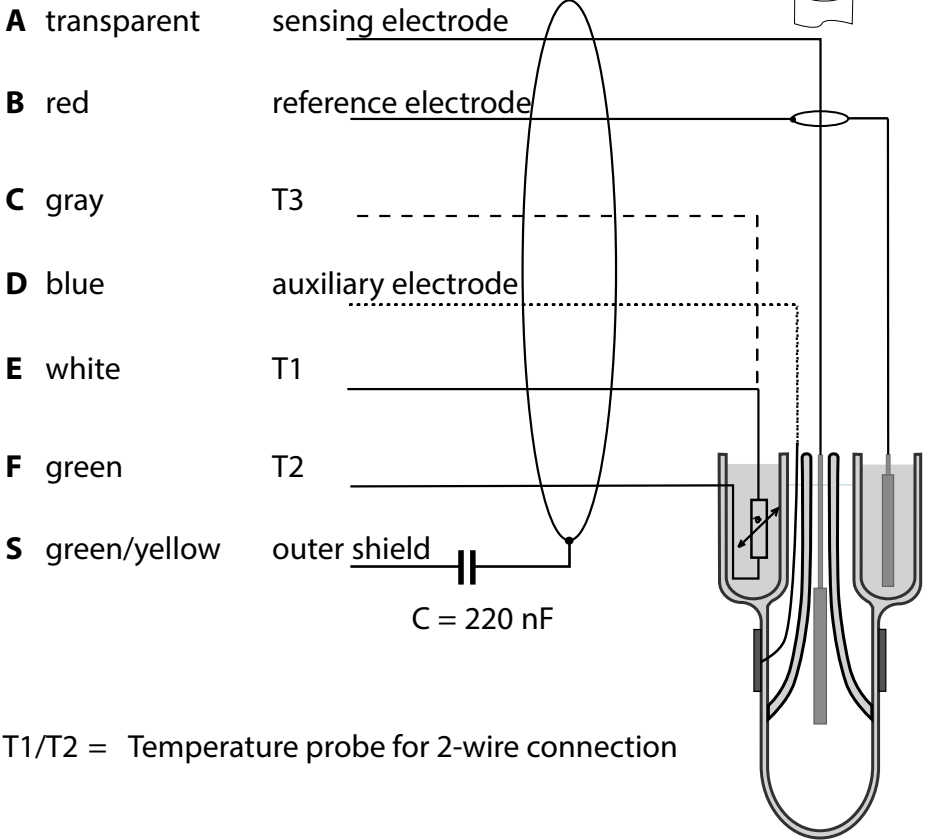
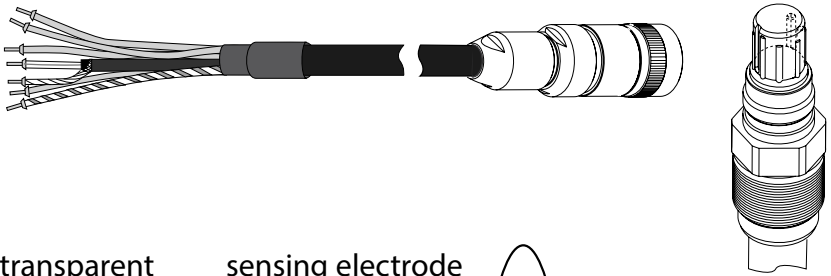

T1/T2 = Temperature probe for 2-wire connection

pH Wiring Examples

Example 1:

pH measurement with monitoring of glass electrode

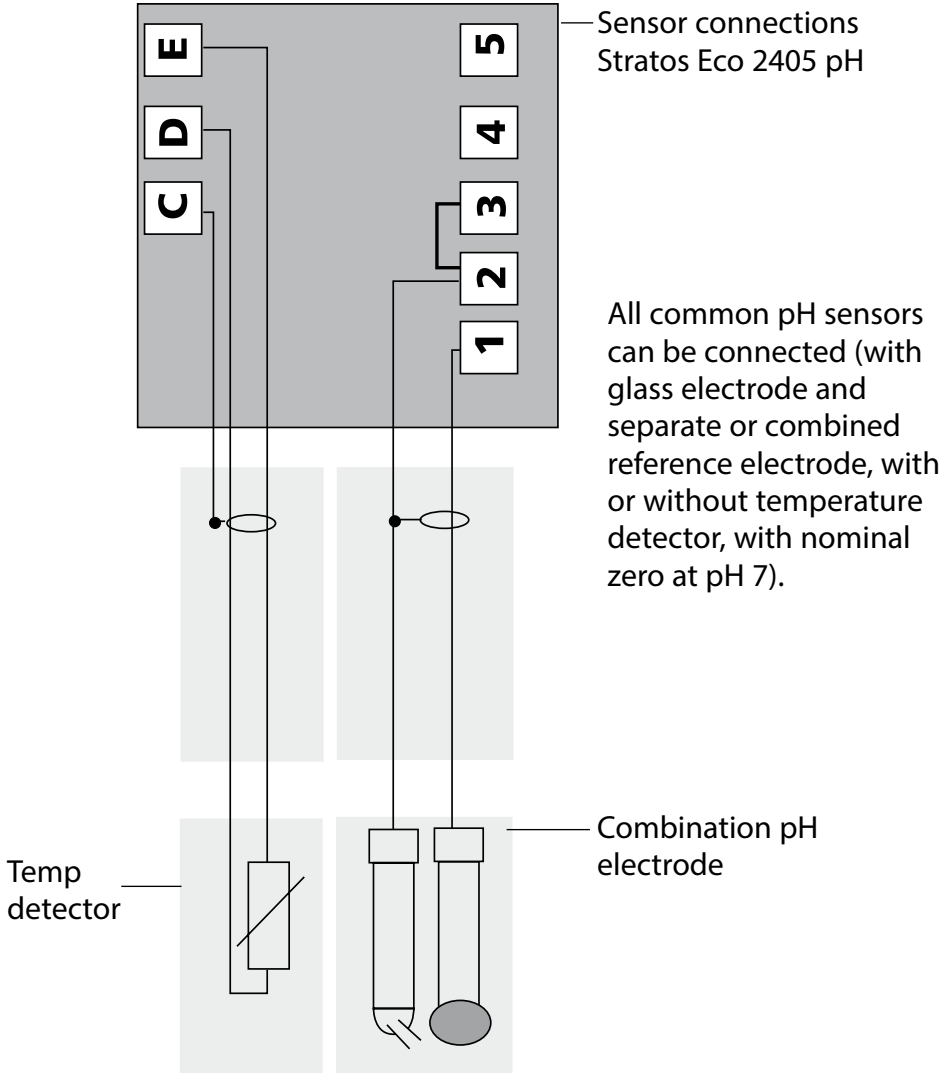

Example 2:

pH measurement with monitoring of glass electrode, without solution ground (SG), VP connection, e.g. SE531, SE532, SE551, SE553, SE538

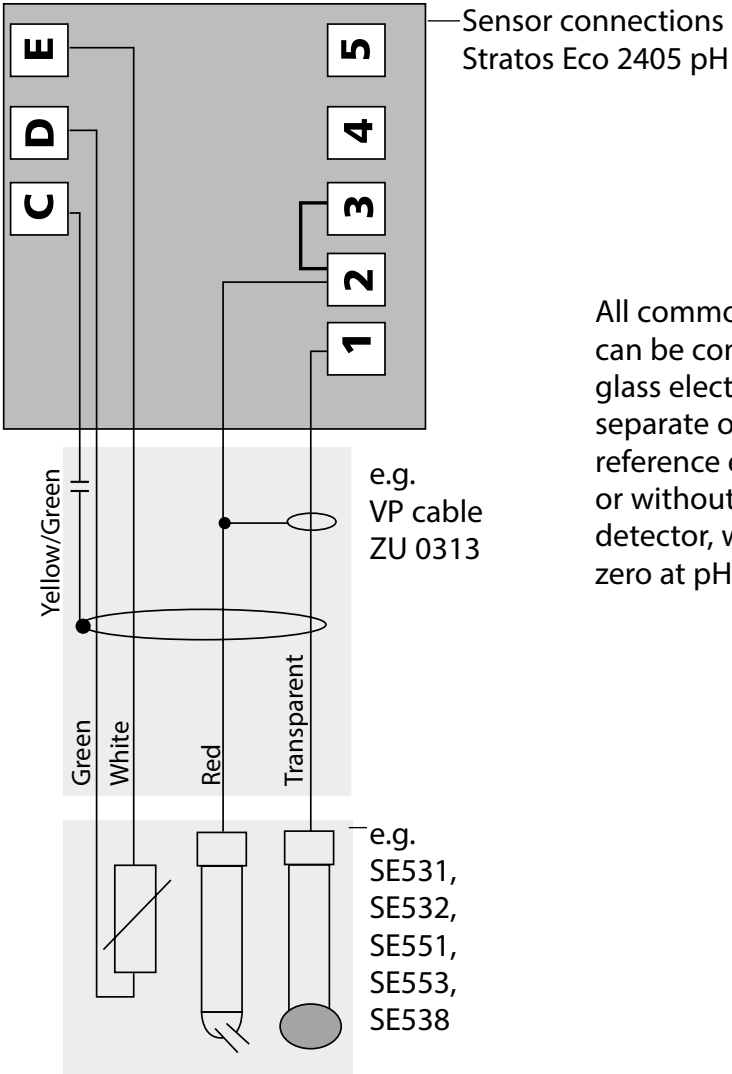

All common pH sensors can be connected (with glass electrode and separate or combined reference electrode, with or without temperature detector, with nominal zero at pH 7).

pH Wiring Examples

Example 3:

pH measurement with monitoring of glass electrode, sensors with solution ground (SG), VP connection, e.g. SE533, SE552

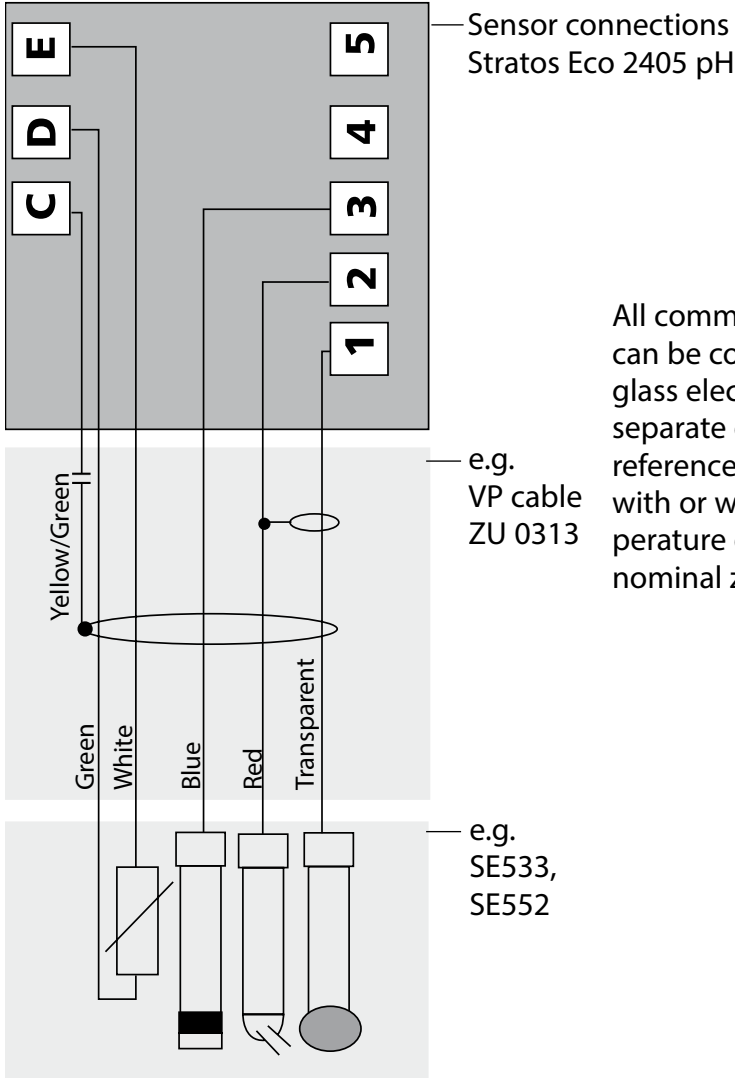

All common pH sensors can be connected (with glass electrode and separate or combined reference electrode, with or without temperature detector, with nominal zero at pH 7).

ORP Wiring Example

Example 4:

ORP measurement

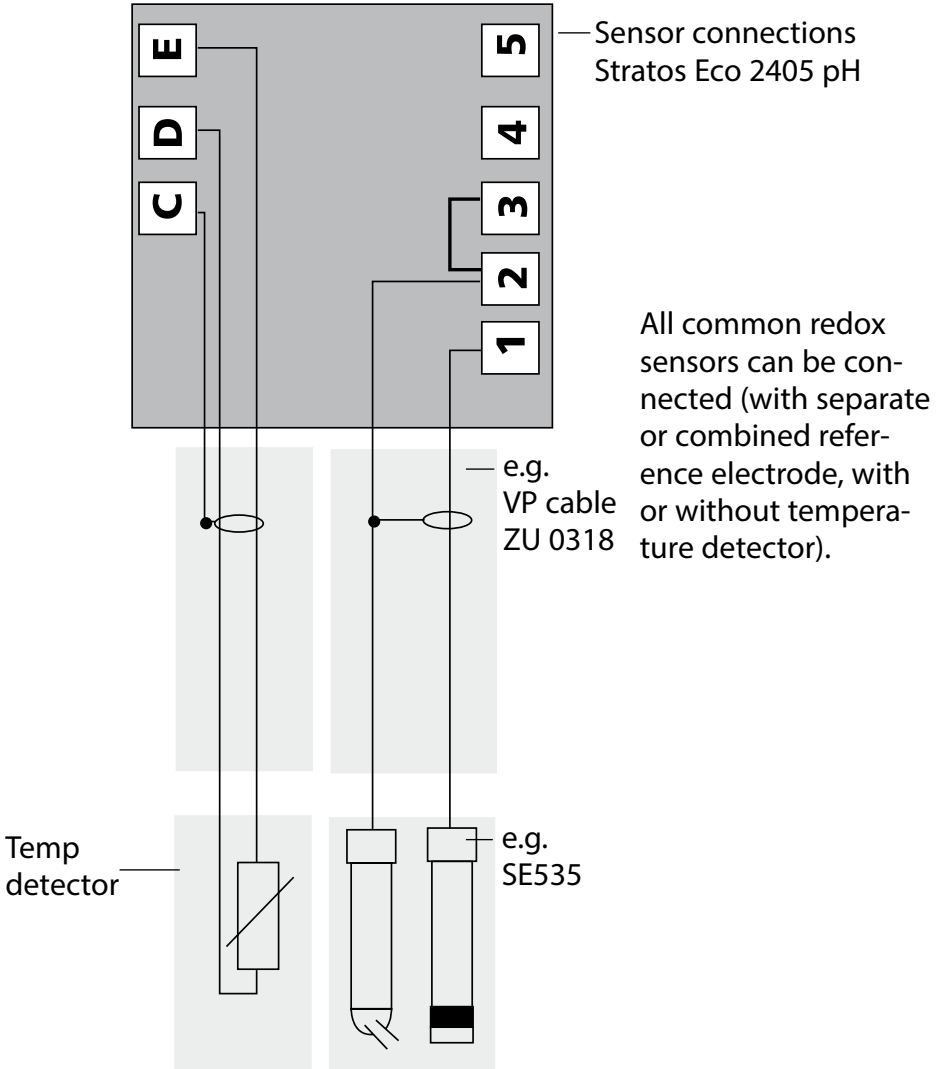

Protective Wiring of Relay Outputs

Protective Wiring of Relay Contacts

Relay contacts are subjected to electrical erosion. Especially with inductive and capacitive loads, the service life of the contacts will be reduced. For suppression of sparks and arcing, components such as RC combinations, nonlinear resistors, series resistors and diodes should be used.

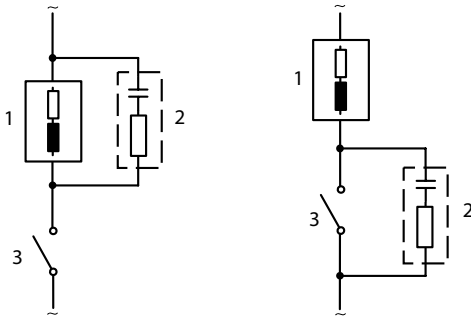

AC applications with inductive load

- 1 Load
- 2 RC combination, e.g. RIFA PMR 209
Typical RC combinations for 230 V AC:
Capacitor 0.1 μF / 630 V Resistor 100 ohms / 1 W
- 3 Contact

Typical Protective Wiring Measures

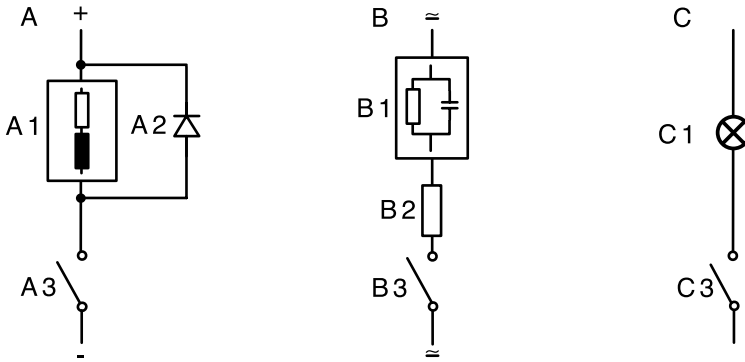

A: DC application with inductive load

B: AC/DC applications with capacitive load

C: Connection of incandescent lamps (resistive load)

A1 Inductive load

A2 Free-wheeling diode, e.g. 1N4007 (Observe polarity)

A3 Contact

B1 Capacitive load

B2 Resistor, e.g. $8 \Omega / 1 \text{ W}$ at $24 \text{ V} / 0.3 \text{ A}$

B3 Contact

C1 Incandescent lamp, max $60 \text{ W} / 230 \text{ V}$, $30 \text{ W} / 115 \text{ V}$

C3 Contact

WARNING!

Make sure that the maximum ratings of the relay contacts are not exceeded even during switching!

User Interface and Display

User Interface

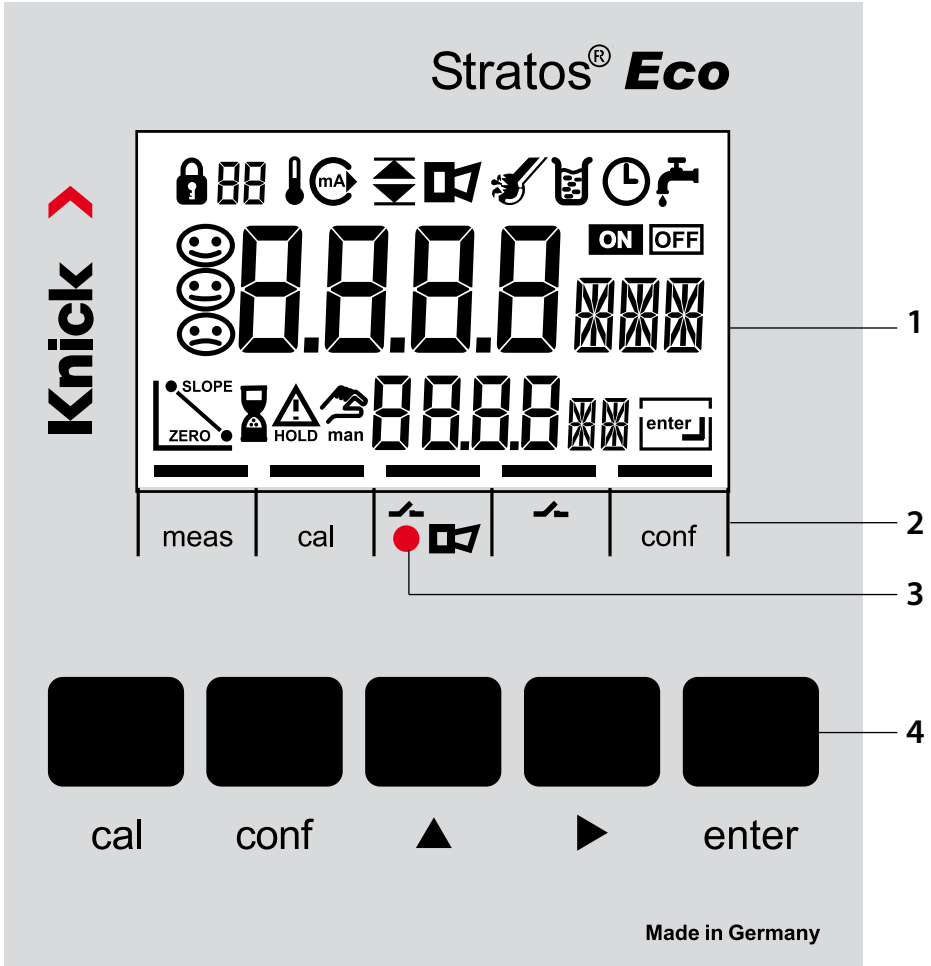

- 1 Display
Mode indicators (no keys),
from left to right:
- Measuring mode
 - Calibration mode
 - Alarm
 - Wash contact
 - Configuration mode

- 2 Alarm LED
3 Keypad

Display

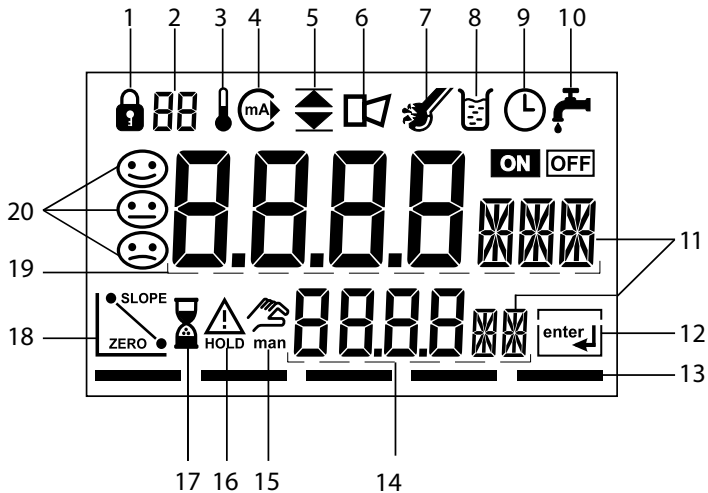

- | | | | |
|----|---|----|----------------------------------|
| 1 | Passcode entry | 14 | Secondary display |
| 2 | Not in use | 15 | Manual temperature specification |
| 3 | Temperature | 16 | Hold mode active |
| 4 | Current output | 17 | Waiting time running |
| 5 | Limit values | 18 | Sensor data |
| 6 | Alarm | 19 | Main display |
| 7 | Sensocheck | 20 | Sensoface |
| 8 | Calibration | | |
| 9 | Interval/response time | | |
| 10 | Wash contact | | |
| 11 | Measurement symbol | | |
| 12 | Press enter to proceed | | |
| 13 | Bar for identifying the device status, above mode indicators, from left to right: | | |
| | - Measuring mode | | |
| | - Calibration mode | | |
| | - Alarm | | |
| | - Not in use | | |
| | - Configuration mode | | |

User Interface and Display

Operation: Keypad

cal	Start, end calibration
conf	Start, end configuration
▶	<ul style="list-style-type: none">• Select digit position (selected position blinks)• Menu navigation
▲	<ul style="list-style-type: none">• Edit digit• Menu navigation
enter	<ul style="list-style-type: none">• Calibration: Continue in program sequence• Configuration: Confirm entries, next configuration step• Measuring mode: Display output current

cal → enter	Cal Info: Display of asymmetry potential (zero) and slope
conf → enter	Error Info: Display of last error message
▶ + ▲	Start GainCheck device self-test

Sensocheck, Sensoface Sensor Monitoring

Sensocheck continuously monitors the sensor and its wiring. Sensocheck can be switched off (Configuration, Pg 52).



Sensoface provides information on the sensor condition. The asymmetry potential (zero), slope and response time during calibration are evaluated. The three Sensoface indicators provide the user with information on wear and required maintenance of the sensor.

GainCheck Device Self-Test

A display test is carried out, the software version is displayed, and the memory and measured-value transfer are checked.

Start GainCheck device self-test: ▶ + ▲

Automatic Device Self-Test

The automatic device self-test checks the memory and measured-value transfer. It runs automatically in the background at fixed intervals.

Safety Functions

Hold Mode

Display: 

The Hold mode is a safety state during configuration and calibration. Output current is frozen (Last) or set to a fixed value (Fix).

Alarm and limit contacts are disabled.

If the calibration or configuration mode is exited, the device remains in the Hold mode for safety reasons. This prevents undesirable reactions of the connected peripherals due to incorrect configuration or calibration. The measured value and "HOLD" are displayed alternately.

The device only returns to measuring mode after **enter** is pressed and 20 seconds have passed.

Configuration mode is also exited automatically 20 minutes (timeout) after the last keystroke. The device returns to measuring mode.

Timeout is not active during calibration.

Behavior of output signal:

Last: The output current is frozen at its last value.
Recommended for short configuration procedures.
The process should not change decisively during configuration.
Changes are not noticed with this setting!

Fix: The output current is set to a value that is noticeably different from the process value in order to signal the control system that the device is being worked at.

See Configuration Pg 40.

Alarm

Alarm delay is 10 seconds.



During an error message the alarm LED blinks.

Error messages can also be signaled by a 22 mA output current.

The alarm contact is activated by alarm or power failure, see also Pg 53.

Configuration

In the Configuration mode you set the device parameters.

<p>Activation</p>	<p>conf</p> 	<p>Activate by pressing conf</p> <p>Enter passcode "1200" Edit parameter using ▶ and ▲, confirm/proceed using enter. (End by pressing conf, then enter.)</p>
<p>HOLD</p> <p>During configuration the device remains in the Hold mode.</p>	 <p>↑ HOLD icon</p>	<p>The output current is frozen (at its last value or at a preset fixed value, depending on the configuration), limit and alarm contacts are inactive. Sensoface is off, "Configuration" mode indicator is on.</p>
<p>Input errors</p>		<p>The configuration parameters are checked during the input. In the case of an incorrect input "Err" is displayed for approx. 2 sec. The incorrect parameters cannot be stored. Input must be repeated.</p>
<p>End</p>	<p>conf</p> <p>enter</p>	<p>End by pressing conf. The measured value and Hold are displayed alternately, "enter" blinks.</p> <p>Press enter key to end the Hold mode. The measured value is displayed. The output current remains frozen for another 20 sec (HOLD icon on, "hourglass" blinks).</p>

Menu Structure of Configuration

The configuration steps are assigned to different menu groups. Using the arrow keys, you can jump between the individual menu groups.

Each menu group contains menu items for setting the parameters. Pressing **enter** opens a menu item.

The values are edited using the arrow keys. Pressing **enter** confirms/saves the settings.

Return to measurement: Press **conf**.

Select menu group	Menu group	Code	Display	Select menu item
▶	Output 1	o1.		enter
		Menu item 1		enter
		Menu item 2		enter
		⋮		enter
		Menu item ...		enter
▶	Output 2	o2.		
▶	Temperature compensation	tc.		
▶	Calibration mode	CA.		
▶	Alarm settings	AL.		
▶	Relay	rL.		
▶	Rinsing probes	Pb.		Previous menu group:

Configuration

Overview of Configuration Steps

Code	Menu	Selection / Default
out1	Output 1	
o1.UnIT	Select process variable	pH / ORP
o1. rNG	Select current range	0-20 mA / 4-20 mA
o1. 4mA	Enter current start	xxxx
o1.20mA	Enter current end	xxxx
o1.FtME	Time constant of output filter	xxxx SEC
o1.FAIL	22 mA signal in the case of error	ON / OFF
o1.HoLD	Signal behavior during HOLD	Last / Fix
o1.FIX	Enter fixed value	xxx.x mA
out2	Output 2	
o2.UnIT	Select temperature unit	°C / °F
o2. rTD	Select temperature probe	Pt100/Pt1000/NTC30/ NTC8.55/Balco3000
o2.rNG	Select current range	0-20 mA / 4-20 mA
o2. 4mA	Enter current start	xxx.x
o2.20mA	Enter current end	xxx.x
o2.FtME	Time constant of output filter	xxxx SEC
o2.FAIL	22 mA signal for temp error	ON / OFF
o2.HoLD	Signal behavior during HOLD	Last / Fix
o2.FIX	Enter fixed value	xxx.x mA
tc.	Temperature compensation	
tc. MEAS	Temp detection during meas	Auto/man (man: xxx.x °C)
tc. CAL	Temp detection during cal	Auto/man (man: xxx.x °C)
tc. LIN	Enter TC process medium	xx.xx %/K
CAL	Calibration mode	
CA. SOL	Select calibration mode	BUF/MAN/DAT
CA.time	Enter cal timer interval	xxxx h

Code	Menu	Selection / Default
ALrt	Alarm settings	
AL.SnSO	Select Sensocheck	ON / OFF
rLAY	Relay 1: Limit	
L1.FCT	Select contact function	Lo / Hi
L1.tYP	Select contact response	N/O / N/C
L1.LEVL	Enter setpoint	xxxx
L1.HYS	Enter hysteresis	xxxx
L1.dLY	Enter delay	xxxx SEC
PrbE	Cleaning probes	
Pb.InTV	Rinse interval	000.0 h
Pb.rins	Rinse duration	xxxx SEC
Pb.typ	Contact response	N/C / N/O

Configuration

Output 1

Process variable (pH/ORP)

1 **conf**



2

Output 1:

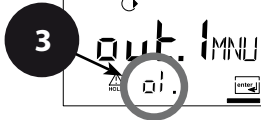

3

enter

4

o1.UnIT	Select process variable
o1. rNG	Select 0-20 / 4-20 mA
o1. 4mA	Enter current start
o1.20mA	Enter current end
o1.FtME	Set output filter
o1.FAIL	22 mA for error
o1.HoLD	HOLD mode

- 1 Press **conf** key.
- 2 Enter passcode **1200**.
- 3 **Output 1** menu group is displayed. All items of this menu group are indicated by the "o1." code.
- 4 Press **enter** to select menu, edit using arrow keys (see Pg 35). Confirm (and proceed) using **enter**.
- 5 End: Press **conf**, then **enter**.

5

conf enter

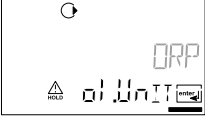
Code	Display	Action	Choices
o1.	 A screenshot of a device's LCD display. At the top, there is a circular arrow icon. Below it, the text 'ORP' is displayed in a large font. Underneath 'ORP', the number '01.0000' is shown. The '01' is in a larger font and has a small vertical bar to its right, indicating it is the active selection. At the bottom of the screen, there are several small icons: a triangle with 'pH', a square with 'ORP', and a square with 'TEMP'. The 'ORP' icon is highlighted with a black bar.	Select variable pH/ORP Select using ▶ arrow key. Press enter to proceed.	pH/ORP

Note: Characters represented in gray are blinking and can be edited.

Configuration

Output 1

Output current range, current start, current end

1 **conf**



2

Output 1:

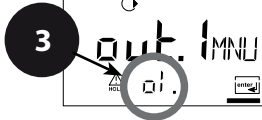

3

enter

- 1 Press **conf** key.
- 2 Enter passcode **1200**.
- 3 **Output 1** menu group is displayed. All items of this menu group are indicated by the "o1." code.
- 4 Press **enter** to select menu, edit using arrow keys (see Pg 37). Confirm (and proceed) using **enter**.
- 5 End: Press **conf**, then **enter**.



4

o1.UnIT	Select process variable
o1. rNG	Select 0-20 / 4-20 mA
o1. 4mA	Enter current start
o1.20mA	Enter current end
o1.FtME	Set output filter
o1.FAIL	22 mA for error
o1.HoLD	HOLD mode

enter

5

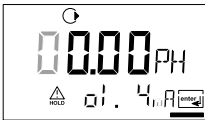
conf enter

Code	Display	Action	Choices
o1.		Set output current range Select using ▶ key, press enter to proceed.	4 - 20 mA (0 - 20 mA)
		Current start Enter lower end of scale, depending on process variable selected (pH or ORP) Select using ▶ key, edit number using ▲ key, press enter to proceed.	pH -2 ... 16 (-1500 mV ... +1500 mV)
		Current end Enter upper end of scale, depending on measured variable selected (pH or ORP) Select using ▶ key, edit number using ▲ key, press enter to proceed.	pH -2 ... 16 (-1500 mV ... +1500 mV)

Assignment of Measured Values: Current Start and Current End

Example 1: Range pH 0 ... 14

Example 2: Range pH 5 ... 7

Advantage: Higher resolution in
range of interest

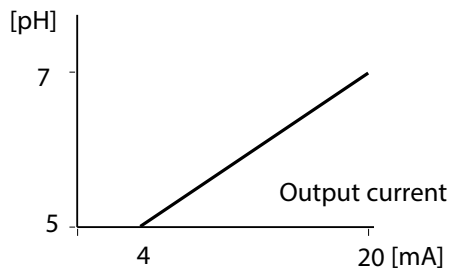
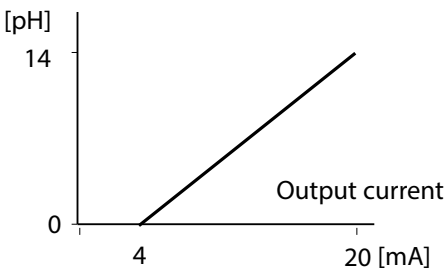

Configuration

Output 1

Time constant of output filter

1 **conf**



2

Output 1:

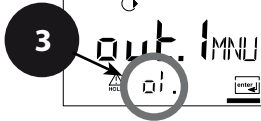

3

enter

o1.UnIT	Select process variable
o1. rNG	Select 0-20 / 4-20 mA
o1. 4mA	Enter current start
o1.20mA	Enter current end
o1.FtME	Set output filter
o1.FAIL	22 mA for error
o1.HoLD	HOLD mode

4

enter



5

conf enter

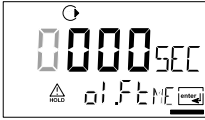
Code	Display	Action	Choices
o1.		Time constant of output filter, default setting: 0 s (inactive). To specify a time constant: Select using ▶ key, edit number using ▲ key, press enter to proceed.	0 sec 0 ... 120 sec

Time Constant of Output Filter (Attenuation)

To smoothen the current output, a low-pass filter with adjustable filter time constant can be switched on. When there is a jump at the input (100 %), the output level is at 63 % after the time constant has been reached.

The time constant can be set from 0 to 120 sec.

If the time constant is set to 0 sec, the current output follows the input.

Please note:

The filter only acts on the current output, not on the display or the limit value!

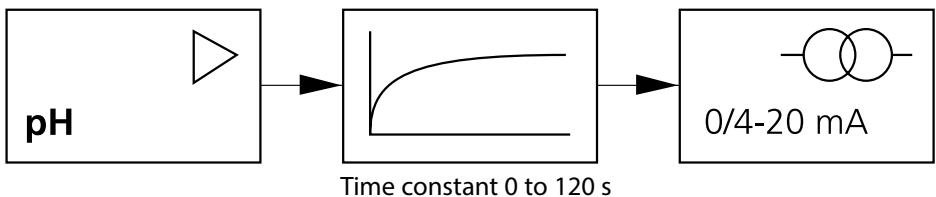

Configuration

Output 1

Output current during Error and HOLD

1 **conf**



2

Output 1:

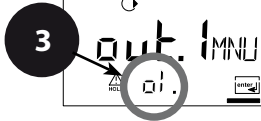

3

enter



- 1 Press **conf** key.
- 2 Enter passcode **1200**.
- 3 **Output 1** menu group is displayed. All items of this menu group are indicated by the "o1." code.
- 4 Press **enter** to select menu, edit using arrow keys (see Pg 41). Confirm (and proceed) using **enter**.
- 5 End: Press **conf**, then **enter**.

4





o1.UnIT	Select process variable
o1. rNG	Select 0-20 / 4-20 mA
o1. 4mA	Enter current start
o1.20mA	Enter current end
o1.FtME	Set output filter
o1.FAIL	22 mA for error
o1.HoLD	HOLD mode

enter



5

conf enter

Code	Display	Action	Choices
o1.		22 mA signal for error message Select using ▶ key, press enter to proceed.	OFF (ON)
		Output signal during HOLD LAST: During HOLD the last measured value is maintained at the output FIX: During HOLD a value (to be entered) is maintained at the output Select using ▶ key, press enter to proceed.	LAST (FIX)
		Only with FIX selected: Enter current which is to flow at the output during HOLD Select position using ▶ key and edit number using ▲ key. Press enter to proceed.	21.0 mA (00.0 ... 21.0 mA)
			

Output Signal During HOLD:

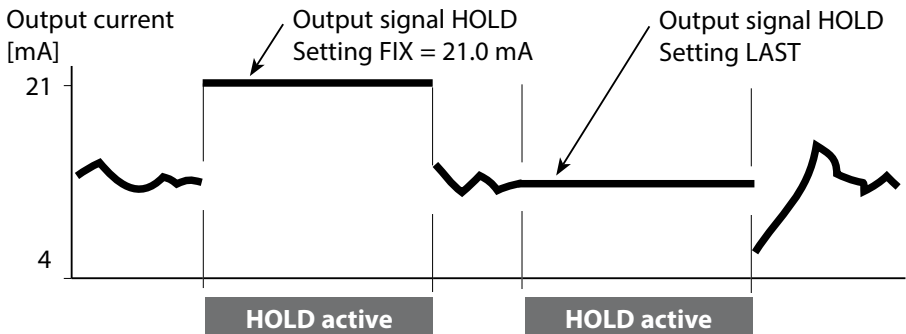

Configuration

Output 2

Temperature unit and probe, output current

1 **conf**

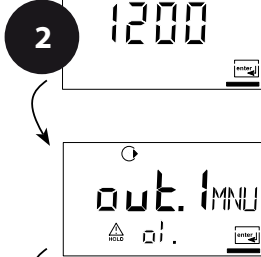

Output 2:

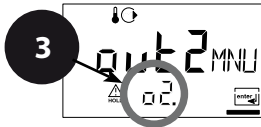

enter





o2.UnIT	Select °C/°F
o2. rTD	Select temp probe
o2.rNG	Select 0-20 / 4-20 mA
o2. 4mA	Enter current start
o2.20mA	Enter current end
o2.FtME	Set output filter
o2.FAIL	22 mA for temp error
o2.HoLD	HOLD mode

enter

- 1 Press **conf** key.
- 2 Enter passcode **1200**.
- 3 Select **Output 2** menu group using arrow keys. All items of this menu group are indicated by the "o2." code.
- 4 Press **enter** to select menu, edit using arrow keys (see Pg 43). Confirm (and proceed) using **enter**.
- 5 End: Press **conf**, then **enter**.

5

conf enter

Code	Display	Action	Choices
o2.		Specify temperature unit Select using ▶ key, press enter to proceed.	°C (°F)
		Select temperature probe Select using ▶ key, press enter to proceed.	Pt1000 (Pt100, NTC30, NTC8.55, Bco3000)
		Select output current range Select using ▶ key, press enter to proceed.	4 - 20 mA (0 - 20 mA)
		Current start: Enter lower end of scale. Select using ▶ key, edit number using ▲ key, press enter to proceed.	000.0 °C
		Current start: Enter upper end of scale. Select using ▶ key, edit number using ▲ key, press enter to proceed.	100.0 °C

Process Temperature: Current Start and Current End

Example 1: Range 0 ... 100 °C

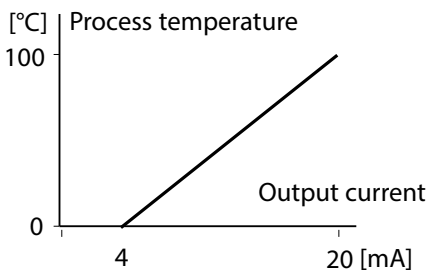

Example 2: Range 50 ... 70 °C
Advantage: Higher resolution in
range of interest

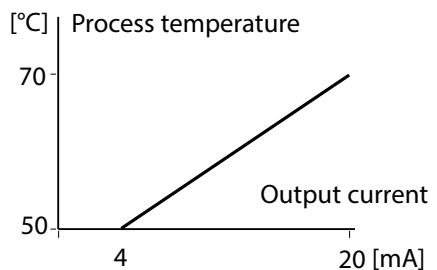

Configuration

Output 2

Time constant of output filter

1 **conf**

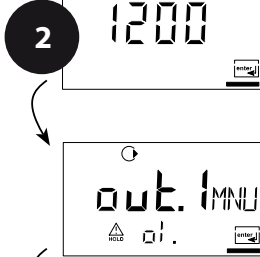

Output 2:

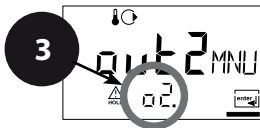

- 1 Press **conf** key.
- 2 Enter passcode **1200**.
- 3 Select **Output 2** menu group using arrow keys. All items of this menu group are indicated by the "o2." code.
- 4 Press **enter** to select menu, edit using arrow keys (see Pg 45). Confirm (and proceed) using **enter**.
- 5 End: Press **conf**, then **enter**.

3	enter	o2.UnIT	Select °C/°F	4	enter
		o2. rTD	Select temp probe		enter
		o2.rNG	Select 0-20 / 4-20 mA		enter
		o2. 4mA	Enter current start		
		o2.20mA	Enter current end		
		o2.FtME	Set output filter		
		o2.FAIL	22 mA for temp error		
		o2.HoLD	HOLD mode		

5 **conf enter**

Code	Display	Action	Choices
o2.		Time constant of output filter Default setting: 0 sec (inactive). To specify a time constant: Select using ▶ key, edit number using ▲ key, press enter to proceed.	0 sec (0 ... 120 sec)

Time Constant of Output Filter

To smoothen the current output, a low-pass filter with adjustable filter time constant can be switched on. When there is a jump at the input (100 %), the output level is at 63 % after the time constant has been reached.

The time constant can be set from 0 to 120 sec.

If the time constant is set to 0 sec, the current output follows the input.

Please note:

The filter only acts on the current output, not on the display!

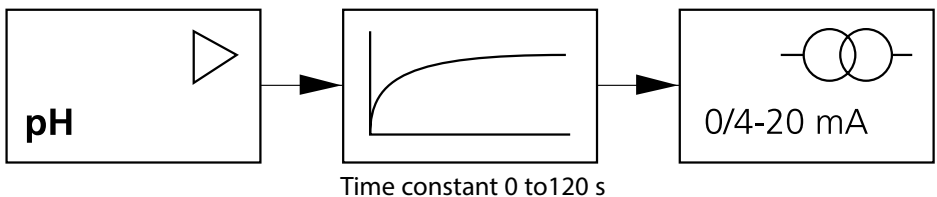

Configuration

Output 2

Temperature error, output current during HOLD

1 **conf**

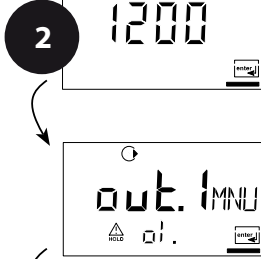

Output 2:

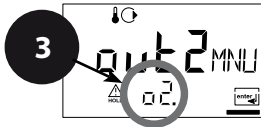

enter

o2.UnIT	Select °C/°F
o2. rTD	Select temp probe
o2.rNG	Select 0-20 / 4-20 mA
o2. 4mA	Enter current start
o2.20mA	Enter current end
o2.FtME	Set output filter
o2.FAIL	22 mA for temp error
o2.HoLD	HOLD mode

enter

- 1 Press **conf** key.
- 2 Enter passcode **1200**.
- 3 Select **Output 2** menu group using arrow keys. All items of this menu group are indicated by the "o1." code.
- 4 Press **enter** to select menu, edit using arrow keys (see Pg 47). Confirm (and proceed) using **enter**.
- 5 End: Press **conf**, then **enter**.

5

conf enter

Code	Display	Action	Choices
o2.		22 mA signal for error message Select using ▶ key, press enter to proceed.	OFF (ON)
		Output signal during HOLD LAST: During HOLD the last measured value is maintained at the output FIX: During HOLD a value (to be entered) is maintained at the output Select using ▶ key, press enter to proceed.	LAST (FIX)
	 	Only with FIX selected: Enter current which is to flow at the output during HOLD Select position using ▶ key and edit number using ▲ key. Press enter to proceed.	21.0 mA (00.0 ... 21.0 mA)

Output Signal During HOLD:

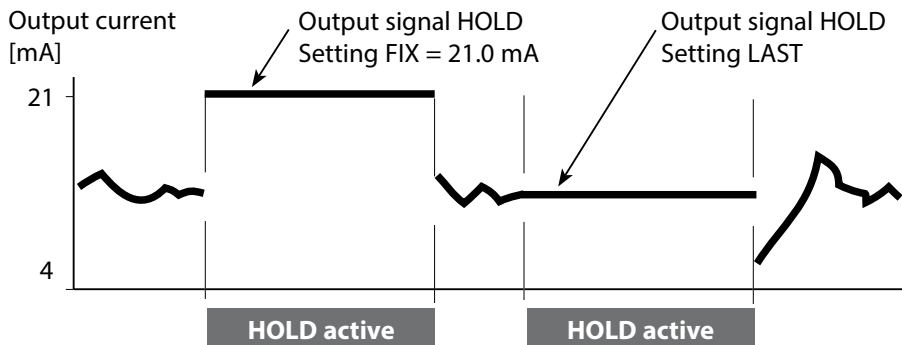



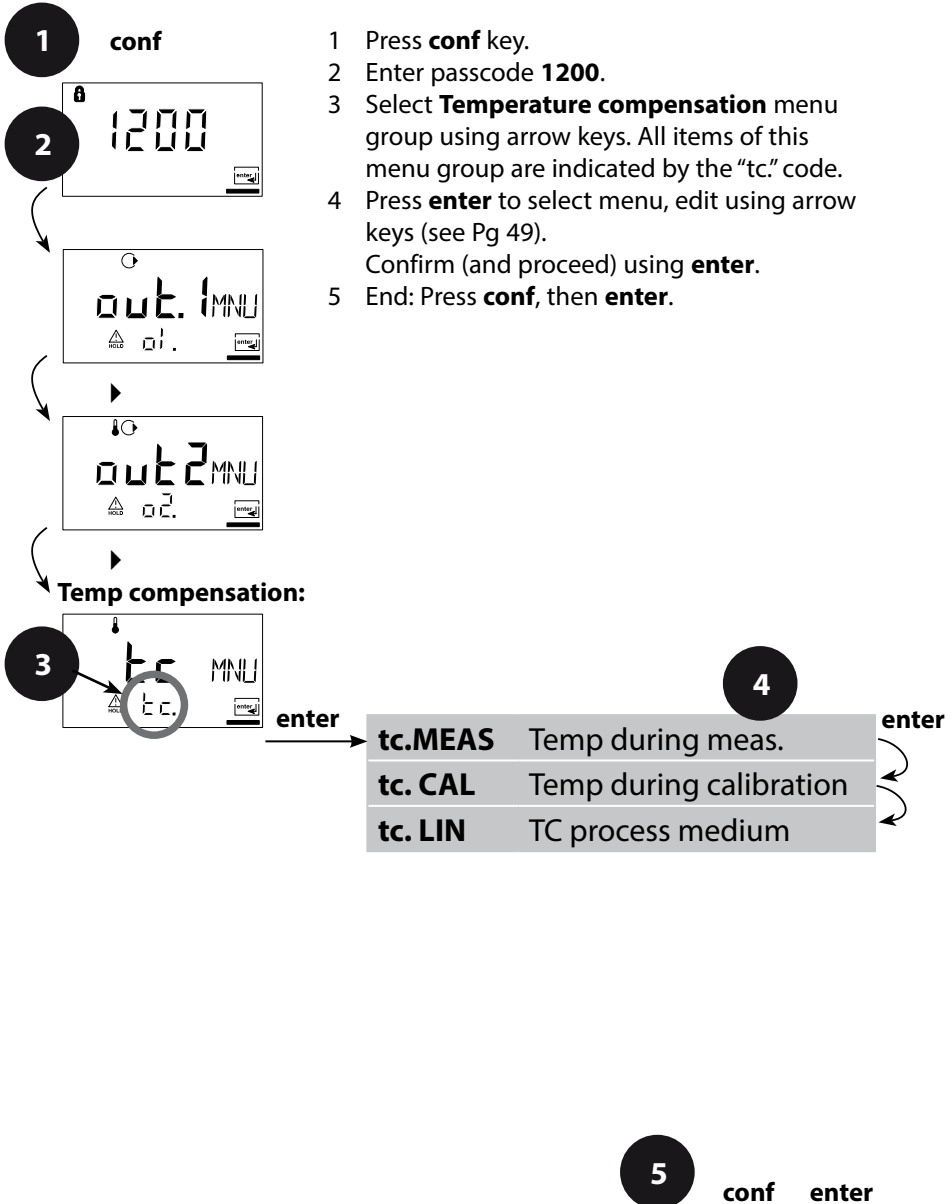

Configuration

Temperature Compensation

Temp detection for meas/cal, TC process medium



Code	Display	Action	Choices
tc.		Select temp detection during measurement (Auto/MAN) AUTO: Temp detection with temperature probe MAN: Manual temperature input Select using ▶ key, press enter to proceed.	AUT (MAN)
		Only with manual temp detection selected (MAN): Enter temperature. Select position using ▶ key and edit number using ▲ key. Press enter to proceed.	25.0 °C (xxx.x °C)
		Select temp detection during calibration (Auto/MAN) Select using ▶ key, press enter to proceed.	AUT (MAN)
		Only with manual temp detection selected (MAN): Enter temperature. Select position using ▶ key and edit number using ▲ key. Press enter to proceed.	25.0 °C (xxx.x °C)
		For pH measurement only: Enter temperature compensation of the process medium Select position using ▶ key and edit number using ▲ key. Press enter to proceed.	00.00 %/K (-19.99 ... 19.99 %/K)

Configuration



Calibration Mode

- 1 Press **conf** key.
- 2 Enter passcode **1200**.
- 3 Select **Calibration mode** menu group using arrow keys. All items of this menu group are indicated by the "CA." code.
- 4 Press **enter** to select menu, edit using arrow keys (see Pg 51). Confirm (and proceed) using **enter**.
- 5 End: Press **conf**, then **enter**.



Calibration mode:

CA. SOL	Calibration mode
CA. tiME	Cal timer interval

5 **conf** **enter**

Code	Display	Action	Choices
CA.		<p>For pH measurement only: Select calibration mode BUF: Calibration with Calimatic automatic buffer selection. To do so, you must select your buffer set:</p> <ul style="list-style-type: none"> -01- BUF: Mettler-Toledo -02-BUF: Knick CaliMat (Merck Titrisols, Riedel Fixanals) -03- BUF: Ciba (94) -04-BUF: NIST technical buffers -05-BUF: NIST standard buffers -06-BUF: HACH buffers -07-BUF: WTW technical buffers -08- BUF: Hamilton Duracal 	<ul style="list-style-type: none"> -01-BUF -02-BUF/ -03-BUF/ -04-BUF/ -05-BUF/ -06-BUF/ -07-BUF/ -08-BUF/ MAN/ DAT)
		<p>MAN: Calibration with manual buffer entry DAT: Entry of asymmetry potential and slope of pre- measured electrodes. Select using ► key, press enter to proceed.</p>	<p>0000 h (0000 ... 9999 h)</p>
		<p>Enter calibration interval: Entry of time interval within which the device is to be calibrated. With a time interval of 0000 hrs, the calibration timer is not active. Select using ► key, edit number using ▲ key, press enter to proceed.</p>	

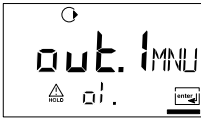
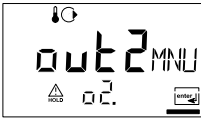
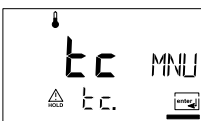
Alarm Settings

- 1 **conf**
- 2 
- 3 

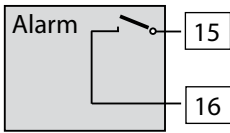

Alarm settings:
 **enter** → **AL. SnSO** Select Sensocheck
- 4
- 5 **conf enter**

Code	Display	Action	Choices
AL.		Select Sensocheck (continuous monitoring of glass and reference electrode) Select using ► key, press enter to proceed.	ON/OFF



Alarm Contact

The alarm contact is closed during normal operation (N/C). It opens in the case of alarm or power outage. As a result, a failure message is provided even in the case of line breakage (fail-safe behavior).

For contact ratings, see Specifications.

Error messages can also be signaled by a 22 mA output current (see Pg 40, 46, 75).

The operating behavior of the alarm contact is shown on Pg 79.

The **alarm delay** acts on the LED, the 22 mA signal and the alarm contact.

Configuration

Limit Function Relay

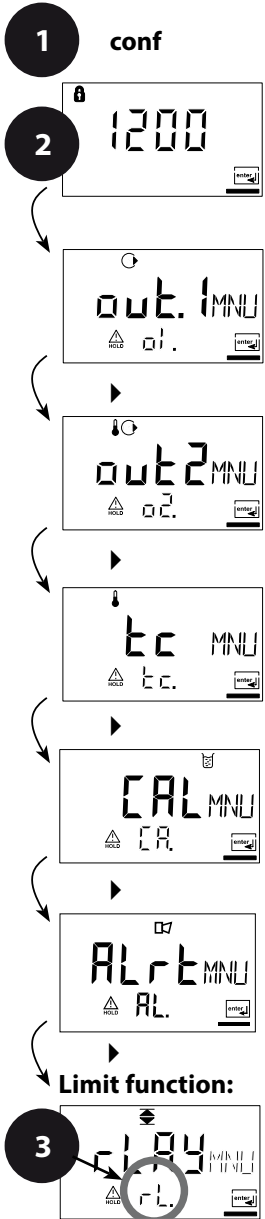

- 1 Press **conf** key.
- 2 Enter passcode **1200**.
- 3 Select **Limit function** menu group using arrow keys. All items of this menu group are indicated by the "L1." code.
- 4 Press **enter** to select menu, edit using arrow keys (see Pg 54). Confirm (and proceed) using **enter**.
- 5 End: Press **conf**, then **enter**.

4

L1.FCT	Contact function	enter
L1.tYP	Contact response	enter
L1.LEVL	Enter setpoint	enter
L1.HYS	Enter hysteresis	
L1.dLY	Delay	

5 conf enter

Code	Display	Action	Choices
L1.		Contact function (see below for function principle) Select using ▶ key, press enter to proceed.	Lo (HI)
		Contact response N/C: normally closed contact N/O: normally open contact Select using ▶ key, press enter to proceed.	N/C (N/O)
		Setpoint Select using ▶ key, edit number using ▲ key, press enter to proceed.	00.00 pH (xx.xx pH)
		Hysteresis Select using ▶ key, edit number using ▲ key, press enter to proceed.	00.50 pH (xx.xx pH)
		Delay The contact is activated with delay (deactivated without delay) Select using ▶ key, edit number using ▲ key, press enter to proceed.	0010 sec (0 ... 9999 sec)

Limit Lo

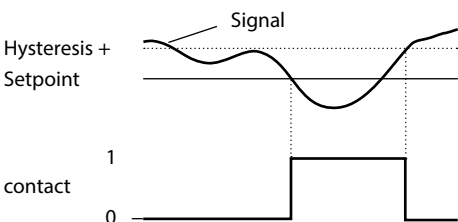

Limit Hi

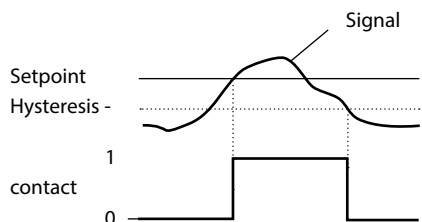

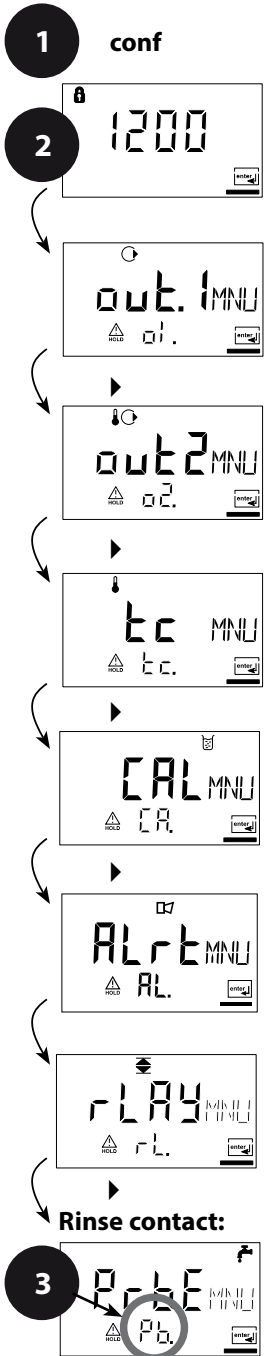

Controlling a Rinsing Probe “Clean” contact



- 1 Press **conf** key.
- 2 Enter passcode **1200**.
- 3 Select **Rinsing probes** menu group using arrow keys. All items of this menu group are indicated by the “Pb.” code.
- 4 Press **enter** to select menu, edit using arrow keys (see next page). Confirm (and proceed) using **enter**.
- 5 End: Press **conf**, then **enter**.

4	Pb.InTV	Rinsing interval	enter ↙ ↘ ↘
	Pb.rins	Rinse duration	
	Pb.typ	Contact response	

Code	Display	Action	Choices
Pb.		Rinsing interval Select using ▶ key, enter number using ▲ , press enter to proceed.	0.000 h (x.xxx h)
		Rinse duration Select using ▶ key, enter number using ▲ , press enter to proceed.	0060 s (xxxx s)
		Contact response N/C: normally closed contact N/O: normally open contact Select using ▶ , press enter to proceed.	N/C (N/O)

Connecting a Rinsing System

The "Clean" contact can be used to connect a simple spray cleaning system. Rinse duration and rinsing interval are defined during configuration.

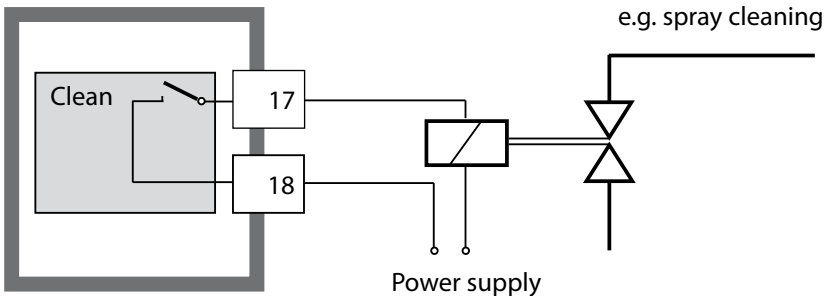

Parameters

Factory Settings of Parameters

Activation:

Simultaneously press **conf** + right arrow key and enter passcode "4321".

The lower display line reads "Clear". To prevent accidental resetting, "NO" is set as default (blinking in the main display). Press one of the arrow keys to select "YES" and confirm by pressing **enter**.

CAUTION!

Your data (also calibration data) will be overwritten by the factory settings!

Code	Parameters	Factory setting
o1.UnIT	pH/ORP unit	pH
o1. rNG	0/4 ... 20 mA	4-20 mA
o1. 4mA	Current start	00.00 pH
o1.20mA	Current end	14.00 pH
o1.FtME	Filter time	0 s
o1.FAIL	22mA signal	OFF
o1.HoLD	HOLD response	Last
o1.FIX	Fix current	021.0 mA
o2.UnIT	Unit °C / °F	°C
o2.rTD	Temp probe	Pt1000
o2.rNG	0/4 ... 20mA	4-20 mA
o2. 4mA	Current start	000.0 °C
o2.20mA	Current end	100.0 °C
o2.FtME	Filter time	0 s
o2.FAIL	22mA signal	OFF
o2.HoLD	HOLD response	Last
o2.FIX	Fix current	021.0 mA

Code	Parameters	Factory setting
tc.MEAS	TC measurement	Auto
tc.MEAS	Measuring temp	025.0 °C
tc. CAL	Calibration	Auto
tc. CAL	Calibration temp	025.0 °C
tc. LIN	TC medium	00.00 %/K
CA. SOL	Cal solution	-01-BUF
CA.tiME	Calibration interval	0000 h
AL.SnSO	Sensocheck	OFF
L1.FCT	Contact function	Lo
L1.tYP	Contact response	N/C
L1.LEVL	Setpoint	00.00 pH
L1.HYS	Hysteresis	00.50 pH
L1.dLY	Delay	0010 sec
Pb.InTV	Rinsing interval	000.0 h
Pb.rins	Rinse duration	0060 s
Pb.typ	Contact type	N/C

Please note:

Fill in your configuration data on the following pages.

Please note:

Factory settings for the calibration data are 98 % (slope) and 0 mV (asymmetry potential).

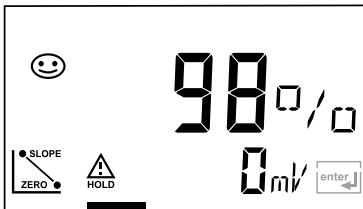

Parameters



Parameters – Individual Settings

Code	Parameter	Setting
o1.UnIT	pH/ORP unit	
o1. rNG	0/4 ... 20 mA	
o1. 4mA	Current start	
o1.20mA	Current end	
o1.FtME	Filter time	
o1.FAIL	22mA signal	
o1.HoLD	HOLD response	
o1.FIX	Fix current	
o2.UnIT	Unit °C / °F	
o2.rTD	Temp probe	
o2.rNG	0/4 ... 20mA	
o2. 4mA	Current start	
o2.20mA	Current end	
o2.FtME	Filter time	
o2.FAIL	22mA signal	

Code	Parameter	Setting
o2.HoLD	HOLD response	
o2.FIX	Fix current	
tc.MEAS	TC measurement	
tc.MEAS	Measuring temp	
tc. CAL	Calibration	
tc. CAL	Calibration temp	
tc. LIN	TC medium	
CA. SOL	Cal solution	
CA.tiME	Cal interval	
AL.SnSO	Sensocheck	
L1.FCT	Contact function	
L1.tYP	Contact response	
L1.LEVL	Setpoint	
L1.HYS	Hysteresis	
L1.dLY	Delay	
Pb.InTV	Rinsing interval	
Pb.rins	Rinse duration	
Pb.typ	Contact type	

Calibration

Calibration adjusts the device to the sensor.

Activation	cal	Activate by pressing cal
		<p>Enter passcode "1100" or "1105" Select using ▲ key. Edit parameter using ▶ . Press enter to proceed. (End by pressing cal, then enter.)</p>
<p>HOLD</p> <p>During calibration the device remains in the Hold mode.</p>	 <p>HOLD icon</p>	<p>During calibration the device remains in the Hold mode for reasons of safety. The output current is frozen (at its last value or at a preset fixed value, depending on the configuration), limit and alarm contacts are inactive. Sensoface is off, "Calibration" mode indicator is on.</p>
Input errors		<p>The calibration parameters are checked during the input. In the case of an incorrect input "Err" is displayed for approx. 2 sec. The incorrect parameters cannot be stored. Input must be repeated.</p>
End	<p>enter</p> <p>enter</p>	<p>End by pressing enter (abort using cal). The measured value and Hold are displayed alternately, "enter" blinks. Sensoface is active. Press enter key to end the Hold mode. The measured value is displayed. The output current remains frozen for another 20 sec (HOLD icon on, "hourglass" blinks).</p>

pH Calibration

Calibration is used to adapt the device to the individual sensor characteristics, namely asymmetry potential and slope. Calibration can be performed with Calimatic automatic buffer recognition, with manual buffer input, by entering premeasured electrode data, or by sampling the product.



CAUTION!



- All calibration procedures must be performed by trained personnel. Incorrectly set parameters may go unnoticed, but change the measuring properties.
- The response time of the sensor and temperature probe is considerably reduced when the sensor is first moved about in the buffer solution and then held still.
- The device can only operate properly when the buffer solutions used correspond to the configured set. Other buffer solutions, even those with the same nominal values, may demonstrate a different temperature response. This leads to measurement errors.
- For calibration without buffer solutions, refer to “Product Calibration”.

Automatic Calibration with Calimatic (BUF -xx-)

Automatic or manual temperature detection

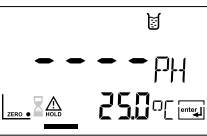
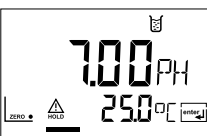
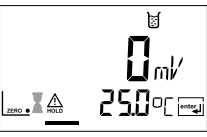
The device can only operate properly when the buffer solutions used correspond to the configured set. Other buffer solutions, even those with the same nominal values, may demonstrate a different temperature response. This leads to measurement errors.

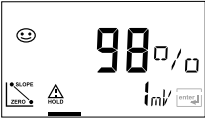
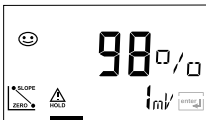



Display	Action	Remark
	Press cal key, enter code 1100. Select using ▶ key, edit number using ▲ key. Press enter to proceed.	If an invalid code is entered, the device returns to measuring mode.
	Remove the sensor and temperature probe, clean them, and immerse them in the first buffer solution (in any order). When "Manual temp detection" has been configured, enter value in the secondary display using the arrow keys. Press enter to start.	Device in Hold mode, measured value frozen. Sensoface inactive.
	Buffer recognition While the "hourglass" icon is blinking, the sensor and temperature probe remain in the first buffer solution.	The response time of the sensor and temperature probe is considerably reduced when the sensor is first moved about in the buffer solution and then held still.
	Buffer recognition terminated, the nominal buffer value is displayed.	
	Stability check: The measured mV value is displayed.	To abort stability check: Press cal . (accuracy reduced)



Display	Action	Remark
	<p>Calibration with the first buffer is terminated. Remove the sensor and temp probe from the first buffer solution and rinse them thoroughly.</p>	
	<ul style="list-style-type: none"> • One-point calibration: End by pressing cal. Slope [%] and asymmetry potential [mV] of the sensor are displayed. Press enter to proceed. 	<p>For one-point calibration only:</p> 
	<ul style="list-style-type: none"> • Two-point calibration: Immerse sensor and temperature probe in the second buffer solution. Press enter to start. 	<p>The calibration process runs again as for the first buffer.</p>
	<p>Retract sensor and temp probe out of second buffer, rinse off, re-install. Repeat calibration: press cal End calibration: press enter</p>	<p>The slope and asymmetry potential of the sensor (based on 25 °C) are displayed.</p>
	<p>pH value and "Hold" are displayed alternately. Sensoface active, "enter" blinks. Press enter to proceed. Hold is deactivated after 20 s.</p>	<p>Confirmation prompt.</p>

Manual Calibration

Automatic or manual temperature detection

For calibration with manual buffer specification, you must enter the pH value of the buffer solution used in the device for the proper temperature. This presetting enables calibration with any desired buffer solution. The MAN calibration mode and the type of temperature detection are selected in the configuration mode.

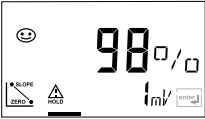
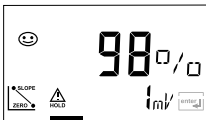





Display	Action	Remark
	Press cal key, enter code 1100. Select using ▶ key, edit number using ▲ key. Press enter to proceed.	If an invalid code is entered, the device returns to measuring mode.
	Remove the sensor and temperature probe, clean them, and immerse them in the first buffer solution (in any order). When "Manual temp detection" has been configured, enter value in the secondary display using the arrow keys. Press enter to start.	Device in Hold mode, measured value frozen. Sensoface inactive.
	Enter the pH value of your buffer solution for the proper temperature. While the "hourglass" icon is blinking, the sensor and temperature probe remain in the buffer solution.	The response time of the sensor and temperature probe is considerably reduced when the sensor is first moved about in the buffer solution and then held still.
	Stability check: The measured mV value is displayed.	To abort stability check: Press cal (accuracy reduced)

Display	Action	Remark
	<p>Calibration with the first buffer is terminated. Remove the sensor and temp probe from the first buffer solution and rinse them thoroughly.</p>	
	<ul style="list-style-type: none"> • One-point calibration: End by pressing cal. Slope [%] and asymmetry potential [mV] of the sensor are displayed. Press enter to proceed. 	<p>For one-point calibration only:</p> 
	<ul style="list-style-type: none"> • Two-point calibration: Immerse sensor and temperature probe in the second buffer solution. Enter pH value of second buffer solution. Press enter to start. 	<p>The calibration process runs again as for the first buffer.</p>
	<p>Retract sensor and temp probe out of second buffer, rinse off, re-install. Repeat calibration: press cal End calibration: press enter</p>	<p>The slope and asymmetry potential of the sensor (based on 25 °C) are displayed.</p>
	<p>pH value and "Hold" are displayed alternately. Sensoface active, "enter" blinks. Press enter to proceed. Hold is deactivated after 20 s.</p>	<p>Confirmation prompt.</p>

Data Entry of Premeasured Electrodes

You can directly enter the values for slope and asymmetry potential of a sensor. The values must be known, e.g. determined beforehand in the laboratory.

The DAT calibration mode must have been preset during configuration.

Display	Action	Remark
	Press cal key, enter code 1100. Select using ▶ key, edit number using ▲ key. Press enter to proceed.	If an invalid code is entered, the device returns to measuring mode.
	Ready for calibration Press enter to start.	Device in Hold mode, measured value frozen. Sensoface inactive.
	Enter asymmetry potential [mV]. Select using ▶ key, edit number using ▲ key. Press enter to proceed.	
	Enter slope [%]. Select using ▶ key, edit number using ▲ key. Press enter to proceed.	
	The device displays the new slope and asymmetry potential (at 25 °C). Press enter to proceed.	
	pH value and "Hold" are displayed alternately. Sensoface active, "enter" blinks. Press enter to proceed. Hold is deactivated after 20 s.	Confirmation prompt.

Product Calibration





Calibration by comparison

Product calibration is a 1-point calibration. During product calibration the sensor remains in the process.

Procedure: Open the product calibration menu. Measure the pH value of the process using a reference meter – e.g. in a bypass or in a sample taken from the process. Then enter this reference value in the analyzer (upper display). The analyzer calculates the new zero point.

Please note:

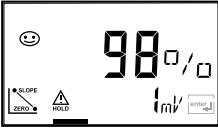
The slope remains unchanged, e.g. 98 % (factory setting).

Display	Action	Remark
	Press cal key, enter code 1105. Press ▶ key to select position, enter number using ▲ key, confirm by pressing enter .	If an invalid code is entered, the device returns to measuring mode.
	The lower display shows the process pH value measured by the device. Enter the measured reference value in the upper line. Press enter to proceed.	The pH value should not change between the reference measurement and enter . Otherwise, you would have to repeat the calibration.
	Display of slope and new zero point. End calibration by pressing enter .	New calibration: Press cal .
	The new value is shown in the main display alternately with "Hold". Sensoface is active, "enter" blinks. End by pressing enter .	After end of calibration, the outputs remain in Hold mode for approx. 20 sec.

Calibration

ORP Calibration

ORP calibration mode is automatically preset when ORP measurement is configured. The potential of a redox (ORP) sensor is calibrated using a redox buffer solution. In the course of that, the difference between the measured potential and the potential of the calibration solution is determined according to the following equation. During measurement the Stratos adds this difference to the measured potential.





$mV_{\text{ORP}} = mV_{\text{meas}} + \Delta mV$	mV_{ORP} = displayed ORP
	mV_{meas} = direct sensor potential
	ΔmV = delta value, determined during calibration

The sensor potential can also be related to another reference system – e.g. the standard hydrogen electrode. In that case the temperature-corrected potential (see table) of the reference electrode used must be entered during calibration. During measurement, this value is then added to the ORP measured.

Please make sure that measurement and calibration temperature are the same, since the temperature response of the reference electrode is not automatically taken into account.

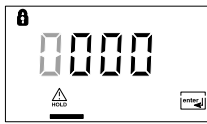
Temperature dependence of commonly used reference systems



Temperature	Ag/AgCl/KCl 1 mol/l [ΔmV]	Ag/AgCl/KCl 3 mol/l [ΔmV]	Thalamid [ΔmV]	Mercury sul- fate [ΔmV]
0	249	224	-559	672
10	244	217	-564	664
20	240	211	-569	655
25	236	207	-571	651
30	233	203	-574	647
40	227	196	-580	639
50	221	188	-585	631
60	214	180	-592	623
70	207	172	-598	613
80	200	163	-605	603

Display	Action	Remark
	Select calibration Press cal key, enter code 1100. Press ▶ key to select position, enter number using ▲ key, confirm by pressing enter .	If an invalid code is entered, the device returns to measuring mode.
	Remove the sensor and temperature probe, clean them and immerse them in the redox buffer.	Welcome (2 sec) Device is in Hold mode.
	Enter setpoint value for redox buffer (secondary display: sensor potential displayed for approx. 6 sec) Select using ▶ key, edit number using ▲ key, confirm by pressing enter .	After approx. 6 sec the secondary display shows the measured temperature.
	Display of sensor data (delta value) Press enter to proceed. Rinse sensor and temperature probe and reinstall them.	"Zero" and "enter" icons are blinking, Sensoface is active.
	The measured ORP value [mV] is shown in the main display alternately with "Hold", Sensoface is active, "enter" blinks. End by pressing enter .	After end of calibration, the outputs remain in Hold mode for approx. 20 sec.

Please note:

Like pH measurement, ORP measurement permits product calibration without using a redox buffer solution. It is performed as described for pH measurement under "Product Calibration" (see Pg 69).

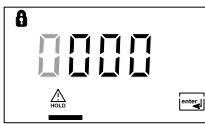



Temp Probe Adjustment

Display	Action	Remark
	<p>Select calibration Press cal key, enter code 1015. Select position usingkey, edit number usingkey, confirm by pressing enter.</p>	<p>Wrong settings change the measure- ment properties! If an invalid code is entered, the device returns to measuring mode.</p>
	<p>Measure the temperature of the process medium using an exter- nal thermometer</p>	<p>Device is in the Hold mode.</p>
	<p>Enter measured temperature value. Select usingkey, edit number using key. Press enter to proceed. Press enter to end adjustment. HOLD will be deactivated after 20 sec.</p>	<p>Default: Value of secondary display.</p>

Measurement





Display	Action
	<p>In the measuring mode the main display shows the configured process variable (pH or ORP [mV]) and the lower display shows the temperature. The device is switched to measuring mode by pressing cal during calibration or by pressing conf during configuration (waiting time for signal stabilization approx. 20 sec).</p>

Diagnostics Functions

Display	Action
 The display shows a main reading of 13.2 mA and a secondary reading of 12.5 mA. A small circular icon is visible in the top left corner.	Display of output currents Press enter while in measuring mode. The current at output 1 is shown in the main display, the current at output 2 in the secondary display. After 5 sec the device returns to measuring mode.
 The display shows a main reading of 98 and a secondary reading of 1 mV. A smiley face icon is in the top left. On the left side, there are icons for SLOPE, ZERO, and HOLD. On the right side, there is an icon for output.	Display of calibration data (Cal Info) Press cal while in measuring mode and confirm code 0000. The slope is shown in the main display, the asymmetry potential in the secondary display. After 20 sec the device returns to measuring mode (immediate return at pressing enter).
 The display shows a main reading of 0 mV and a secondary reading of 25.0 °C. A triangle icon is in the bottom left.	Display of sensor potential (Sensor Monitor) Press conf while in measuring mode and enter code 2222. The (uncompensated) sensor potential is shown in the main display, the measuring temperature in the secondary display. Press enter to return to measurement.
 The display shows the text 'LAST' in large letters and 'Error' in smaller letters below it. A smiley face icon is in the top left.	Display of last error message (Error Info) Press conf while in measuring mode and confirm code 0000. The last error message is displayed for approx. 20 sec. After that the message will be deleted (immediate return to measurement at pressing enter).

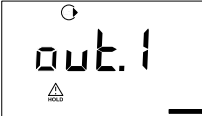
Diagnosics Functions















These functions are used for testing the connected peripherals.

Display	Action
	Specify current at output 1 Press conf while in measuring mode and enter code 5555. The current indicated in the main display for output 1 can be edited.
	Select using ▶ key, edit number using ▲ key. Confirm entry by pressing enter . The entered value will be shown in the secondary display. The device is in Hold mode. Press conf , then enter to return to measurement (Hold remains active for another 20 sec).
	Specify current at output 2 Press conf while in measuring mode and enter code 5556. The current indicated in the main display for output 2 can be edited.
	Select using ▶ key, edit number using ▲ key. Confirm entry by pressing enter . The entered value will be shown in the secondary display. The device is in Hold mode. Press conf , then enter to return to measurement (Hold remains active for another 20 sec).



Error Messages (Error Codes)

Error	Display	Problem Possible causes	Alarm contact	Red LED	Out 1 (22 mA)	Out 2 (22 mA)
ERR 01	Measured value blinks	pH sensor <ul style="list-style-type: none"> • Sensor defective • Not enough electrolyte in sensor • Sensor not connected • Break in sensor cable • Wrong sensor connected • Measured pH value < -2 or > 16 • Measured ORP value < -1999 mV or > 1999 mV 	x	x	x	
ERR 02	Measured value blinks	ORP sensor <ul style="list-style-type: none"> • Sensor defective • Sensor not connected • Break in sensor cable • Wrong sensor connected • Sensor potential < -1500 mV • Sensor potential > 1500 mV 	x	x	x	
ERR 98	“Conf” blinks	System error Configuration or calibration data defective; completely reconfigure the device using the factory settings. Then calibrate. Memory error in device program	x	x	x	x
ERR 99	“FAIL” blinks	Factory settings EEPROM or RAM defective This error message only occurs in the case of a total defect. The device must be repaired and recalibrated at the factory.	x	x	x	x

Error Messages (Error Codes)

Error	Icon (blinks)	Problem Possible causes	Alarm contact	Red LED	Out 1 (22 mA)	Out 2 (22 mA)
ERR 03		Temperature probe Open or short circuit Temperature range exceeded	x	x	x	x
ERR 11		Current output 1 Current below 0 (3.8) mA	x	x	x	
ERR 12		Current output 1 Current above 20.5 mA	x	x	x	
ERR 13		Current output 1 Current span too small / too large	x	x	x	
ERR 21		Current output 2 Current below 0 (3.8) mA	x	x		x
ERR 22	 	Current output 2 Current above 20.5 mA	x	x		x
ERR 23	 	Current output 2 Current span too small / too large	x	x		x
ERR 33		Sensocheck Glass electrode	x	x	x	
		• Zero error, Sensoface active, see Pg 81				
		• Slope error, Sensoface active, see Pg 81				
		• Response time exceeded, Sensoface active, see Pg 81				
		• Calibration interval expired, Sensoface active, see Pg 81				

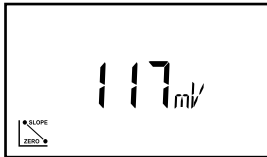





























Calibration Error Messages

Icon blinks:	Problem Possible causes
 <p>The icon displays the value '117 mV' in a digital font. To the left of the value is a small graph showing a downward-sloping line with a point labeled 'ZERO' at the bottom left and a point labeled 'SLOPE' at the top right.</p>	<p>Asymmetry potential out of range (± 60 mV)</p> <ul style="list-style-type: none">• Sensor worn out• Buffer solutions unusable or contaminated• Buffer does not belong to configured buffer set• Temperature probe not immersed in buffer solution (for automatic temperature compensation)• Wrong buffer temperature set (for manual temperature specification)• Nominal sensor zero point \neq pH 7
 <p>The icon displays the value '120 %' in a digital font. To the left of the value is a small graph showing a downward-sloping line with a point labeled 'ZERO' at the bottom left and a point labeled 'SLOPE' at the top right.</p>	<p>Sensor slope out of range (80...103 %)</p> <ul style="list-style-type: none">• Sensor worn out• Buffer solutions unusable or contaminated• Buffer does not belong to configured buffer set• Temperature probe not immersed in buffer solution (for automatic temperature compensation)• Wrong buffer temperature set (for manual temperature specification)• Sensor used has different nominal slope
 <p>The icon displays the text 'CAL ERR' in a digital font. Above the 'A' in 'CAL' is a small warning symbol (a triangle with an exclamation mark).</p>	<p>Problems during recognition of the buffer solution</p> <ul style="list-style-type: none">• Same or similar buffer solution was used for both calibration steps• Buffer solution used does not belong to buffer set currently configured in the device• During manual calibration the buffer solutions were not used in the specified order• Buffer solutions unusable or contaminated• Wrong buffer temperature set (for manual temperature specification)• Sensor defective• Sensor not connected• Sensor cable defective

Calibration Error Messages

Icon blinks:	Problem Possible causes
 The icon shows the text 'CAL ERR' in a digital font. Above the 'A' in 'CAL' is a small clock icon. The entire icon is enclosed in a rectangular border.	<p>Calibration was canceled after approx. 2 minutes because the sensor drift was too large.</p> <ul style="list-style-type: none">• Sensor defective• Sensor dirty• No electrolyte in the sensor• Sensor cable insufficiently shielded or defective• Strong electric fields influence the measurement• Major temperature fluctuation of the buffer solution• No buffer solution or extremely diluted

Operating States

Operating status	Out 1	Out 2	Relay 1 limit value	Alarm contact	Cleaning contact	Timeout
Measure						
Cal Info (cal) 0000						20 s
Error Info (conf) 0000						20 s
Calibration (cal) 1100						
Temp adjustment (cal) 1015						
Product calibration (cal) 1105						
Configuration (conf) 1200						20 min
Sensor monitor (conf) 2222						20 min
Current source 1 (conf) 5555						20 min
Current source 2 (conf) 5556						20 min
Rinsing function						

 active

 as configured (Last/Fix or Last/Off)

Sensoface

(Sensocheck must have been activated during configuration.)

The smiley in the display (Sensoface) alerts to sensor problems (defective sensor, defective cable, maintenance required). The permitted calibration ranges and the conditions for a friendly, neutral, or sad Sensoface are summarized in the following table. Additional icons refer to the error cause.

Sensocheck









Continuously monitors the sensor and leads for short circuits or open circuits. Critical values make the Sensoface “sad” and the corresponding icon blinks:



The Sensocheck message is also output as error message Err 33. The alarm contact is active, the red LED is lit, output current 1 is set to 22 mA (when configured correspondingly). Sensocheck can be switched off during configuration (then Sensoface is also disabled). Exception: After a calibration a smiley is always displayed for confirmation.

Notice

The worsening of a Sensoface criterion leads to the devaluation of the Sensoface indicator (Smiley becomes “sad”). An improvement of the Sensoface indicator can only take place after calibration or removal of the sensor defect.

Display	Problem	Status
	Asymmetry potential and slope	<p>  Asymmetry potential (zero) and slope of the sensor are still okay. The sensor should be replaced soon. </p> <p>  Asymmetry potential and slope of the sensor have reached values which no longer ensure proper calibration. Replace the sensor. </p>
	Calibration timer	<p>  Over 80 % of the calibration interval has already past. </p> <p>  The calibration interval has been exceeded. </p>
	Sensor defect	<p>  Check the sensor and its connections (see also Err 33, Error Messages on Pg 76). </p>

Product Line and Accessories

Devices

Stratos Eco 2405 pH

Order No.

2405 pH

Mounting Accessories

Pipe-mount kit

ZU 0274

Panel-mount kit

ZU 0275

Protective hood

ZU 0276

For more information concerning our sensors and fittings product line,
please refer to our website:
www.knick.de

Specifications

pH/mV input	Input for pH or ORP sensors	
Measuring range	-1500 ... +1500 mV	
Display range	pH value	-2.00 ... 16.00
	ORP	-1999 ... +1999 mV
Glass electrode input ¹⁾		
Input resistance	> 0.5 x 10 ¹² ohms	
Input current	< 2 x 10 ⁻¹² A	
Reference electrode input ¹⁾		
Input resistance	> 1 x 10 ¹⁰ ohms	
Input current	< 1 x 10 ⁻¹⁰ A	
Meas. error ^{1,2,3)}		
pH value	< 0.02	TC: 0.002 pH/K (display)
mV value	< 1 mV	TC: 0.1 mV/K
pH sensor standardization *	pH calibration	
Operating modes	BUF	Calibration with automatic buffer recognition Calimatic:
	Buffer sets	
	-01-	Knick / Mettler-Toledo 2.00/4.01/7.00/9.21
	-02-	Merck/Riedel de Haen 2.00/4.00/7.00/9.00/12.00
	-03-	Ciba (94) 2.06/4.00/7.00/10.00
	-04-	NIST technical 1.68/4.00/7.00/10.01/12.46
	-05-	NIST standard 1.680/4.008/6.865/9.184
	-06-	HACH 4.00/7.00/10.01
	-07-	WTW technical buffers 2.00/4.01/7.00/10.00
	-08-	Hamilton 4.01/7.00/10.01

	MAN	Calibration with manual entry of individual buffer values
	DAT	Data entry of pre-measured electrodes
Max. calibration range		Asymmetry potential: ± 60 mV Slope: 80 ... 103 % (47.5 ... 61 mV/pH)
ORP sensor standardization*		ORP calibration
Max. calibration range		-700 ... +700 Δ mV
Calibration timer		0000 ... 9999 h
Sensocheck		Automatic monitoring of glass electrode (can be disabled)
Sensoface		Provides information on the sensor condition Evaluation of zero/slope, response, calibration interval, Sensocheck
Temperature input*		Pt100/Pt1000/NTC 30 k Ω /NTC 8.55 k Ω /Balco 3k Ω 2-wire connection, adjustable
Measuring range	Pt 100/Pt 1000	-20.0 ... +200.0 $^{\circ}$ C (-4 ... +392 $^{\circ}$ F)
	NTC 30 kohms	-20.0 ... +150.0 $^{\circ}$ C (-4 ... +302 $^{\circ}$ F)
	NTC 8.55 kohms	-10.0 ... +130.0 $^{\circ}$ C (14 ... +266 $^{\circ}$ F)
	Balco 3 kohms	0.0 ... +100.0 $^{\circ}$ C (+32 ... +212 $^{\circ}$ F)
Adjustment range		10 K
Resolution		0.1 $^{\circ}$ C / 1 $^{\circ}$ F
Meas. error ^{1,2,3)}		< 0.5 K (< 1K for Pt100; < 1K for NTC > 100 $^{\circ}$ C)
Temperature compensation of process medium		Linear -19.99 ... +19.99 %/K (reference temp 25 $^{\circ}$ C)

Specifications

Output 1	0/4 ... 20 mA, max. 10 V, floating (galvanically connected to output 2)
Process variable*	pH or mV value
Overrange *	22 mA in the case of error messages
Output filter *	Low-pass, filter time constant 0 ... 120 s
Measurement error ¹⁾	< 0.3% current value + 0.05 mA
Start/end of scale	Configurable within the measuring range for pH or mV
Admissible span	pH 2.00 ... 18.00 / 200 ... 3000 mV
Output 2	0/4 ... 20 mA, max. 10 V, floating (galvanically connected to output 1)
Process variable	Temperature
Overrange *	22 mA in case of temp error messages
Output filter *	Low-pass, filter time constant 0 ... 120 s
Measurement error ¹⁾	< 0.3% current value + 0.05 mA
Start/end of scale *	-20 ... 200 °C / -4 ... 392 °F
Admissible span	20 ... 220 K / 36 ... 396 °F
Alarm contact	Relay contact, floating
Contact ratings	AC < 250 V / < 3 A / < 750 VA DC < 30 V / < 3 A / < 90 W
Contact response	N/C (fail-safe type)
Alarm delay	10 s
Limit values	Output via relay contact
Contact ratings	AC < 250 V / < 3 A / < 750 VA DC < 30 V / < 3 A / < 90 W
Contact response*	N/C or N/O
Delay *	0000 ... 9999 s
Switching points*	As desired within range
Hysteresis*	00.00 ... 05.00 pH / 0000 ... 0500 mV

Cleaning function	Relay contact, floating, for controlling a simple rinsing system or an automatic cleaning system
Contact ratings	AC < 250 V / < 3 A / < 750 VA DC < 30 V / < 3 A / < 90 W
Contact response	N/C or N/O
Rinse interval	000.0 ... 999.9 h (000.0 h = cleaning function switched off)
Rinse duration	0000 ... 1999 s
Display	LC display, 7-segment with icons
Main display	Character height 17 mm, unit symbols 10 mm
Secondary display	Character height 10 mm, unit symbols 7 mm
Sensoface	3 status indicators (friendly, neutral, sad face)
Mode indication	4 mode indicators "meas", "cal", "alarm", "config" Further icons for configuration and messages
Alarm indication	Red LED in case of alarm
Keypad	5 keys: [cal] [conf] [▶] [▲] [enter]
Service functions	
Current source	Current specifiable for output 1 and 2 (00.00 ... 22.00 mA)
Device self-test	Automatic memory test (RAM, FLASH, EEPROM)
Display test	Display of all segments
Last Error	Display of last error occurred
Sensor monitor	Display of direct, uncorrected sensor signal
Data retention	Parameters and calibration data > 10 years (EEPROM)
Protection against electric shock	Safe electrical isolation of all extra-low-voltage circuits against mains by double insulation to EN 61010-1

Specifications

Power supply 24 (-15%) ... 230 V AC/DC (+10%); approx. 5 VA, 2.5 W,
AC: 45 ... 65 Hz
Overvoltage category II, protection class II

Nominal operating conditions

Ambient temperature -20 ... +55 °C / -4 ... +131 °F
Transport/Storage temp -20 ... +70 °C / -4 ... +158 °F
Relative humidity 10...95 % not condensing,
maximum operating height 2000 m
Power supply 24 (-15%) ... 230 V AC/DC (+10%)
Frequency for AC 45 ... 65 Hz

EMC

EN 61326-1, EN 61326-2-3
Emitted interference Class B (residential area)
Class A for mains > 60 V DC
Immunity to interference Industry

Explosion protection

FM NI Class I Div 2 Group A, B, C & D, T4
Ta = 55 °C; Type 2
NI Class I Zone 2 Group IIC, T4 Ta = 55°C; Type 2

Enclosure

Molded enclosure made of PBT,
glass bead reinforced
Color Black
Mounting

- Wall mounting
- Pipe mounting: Ø 40 ... 60 mm □ 30 ... 45 mm
- Panel mounting,
cutout to DIN 43 700,
sealed against panel

Dimensions H 144 mm, W 144 mm, D 105 mm
Ingress protection IP 65 / NEMA 4X

Cable glands	3 knockouts for cable glands M20x1.5 2 knockouts for NPT 1/2" or rigid metallic conduit
Weight	Approx.1 kg

* User-defined

1) To IEC 746 Part 1, at nominal operating conditions

2) ± 1 count

3) Plus sensor error

Buffer Tables

-01- Mettler-Toledo technical buffers

°C	pH			
0	2.03	4.01	7.12	9.52
5	2.02	4.01	7.09	9.45
10	2.01	4.00	7.06	9.38
15	2.00	4.00	7.04	9.32
20	2.00	4.00	7.02	9.26
25	2.00	4.01	7.00	9.21
30	1.99	4.01	6.99	9.16
35	1.99	4.02	6.98	9.11
40	1.98	4.03	6.97	9.06
45	1.98	4.04	6.97	9.03
50	1.98	4.06	6.97	8.99
55	1.98	4.08	6.98	8.96
60	1.98	4.10	6.98	8.93
65	1.99	4.13	6.99	8.90
70	1.99	4.16	7.00	8.88
75	2.00	4.19	7.02	8.85
80	2.00	4.22	7.04	8.83
85	2.00	4.26	7.06	8.81
90	2.00	4.30	7.09	8.79
95	2.00	4.35	7.12	8.77

-02- Knick CaliMat
(Merck Titrisols, Riedel-de-Haen Fixanals)

°C	pH				
Order No.	CS-P0200A/...	CS-P0400A/...	CS-P0700A/...	CS-P0900A/...	CS-P1200A/...
0	2.01	4.05	7.09	9.24	12.58
5	2.01	4.04	7.07	9.16	12.39
10	2.01	4.02	7.04	9.11	12.26
15	2.00	4.01	7.02	9.05	12.13
20	2.00	4.00	7.00	9.00	12.00
25	2.00	4.01	6.99	8.95	11.87
30	2.00	4.01	6.98	8.91	11.75
35	2.00	4.01	6.96	8.88	11.64
40	2.00	4.01	6.96	8.85	11.53
50	2.00	4.01	6.96	8.79	11.31
60	2.00	4.00	6.96	8,73	11.09
70	2.00	4.00	6.96	8,70	10.88
80	2.00	4.00	6.98	8,66	10.68
90	2.00	4.00	7.00	8,64	10.48

Buffer Tables

-03- Ciba (94) buffers
Nominal values: 2.06, 4.00, 7.00, 10.00

°C	pH			
0	2.04	4.00	7.10	10.30
5	2.09	4.02	7.08	10.21
10	2.07	4.00	7.05	10.14
15	2.08	4.00	7.02	10.06
20	2.09	4.01	6.98	9.99
25	2.08	4.02	6.98	9.95
30	2.06	4.00	6.96	9.89
35	2.06	4.01	6.95	9.85
40	2.07	4.02	6.94	9.81
45	2.06	4.03	6.93	9.77
50	2.06	4.04	6.93	9.73
55	2.05	4.05	6.91	9.68
60	2.08	4.10	6.93	9.66
65	2.07 *	4.10 *	6.92 *	9.61 *
70	2.07	4.11	6.92	9.57
75	2.04 *	4.13 *	6.92 *	9.54 *
80	2.02	4.15	6.93	9.52
85	2.03 *	4.17 *	6.95 *	9.47 *
90	2.04	4.20	6.97	9.43
95	2.05 *	4.22 *	6.99 *	9.38 *

* extrapolated

-04- NIST technical buffers

°C	pH				
0	1.67	4.00	7.11 ₅	10.32	13.42
5	1.67	4.00	7.08 ₅	10.25	13.21
10	1.67	4.00	7.06	10.18	13.01
15	1.67	4.00	7.04	10.12	12.80
20	1.67 ₅	4.00	7.01 ₅	10.06	12.64
25	1.68	4.00₅	7.00	10.01	12.46
30	1.68	4.01 ₅	6.98 ₅	9.97	12.30
35	1.69	4.02 ₅	6.98	9.93	12.13
40	1.69	4.03	6.97 ₅	9.89	11.99
45	1.70	4.04 ₅	6.97 ₅	9.86	11.84
50	1.70 ₅	4.06	6.97	9.83	11.71
55	1.71 ₅	4.07 ₅	6.97	9.83 *	11.57
60	1.72	4.08 ₅	6.97	9.83 *	11.45
65	1.73	4.10	6.98	9.83 *	11.45 *
70	1.74	4.13	6.99	9.83 *	11.45 *
75	1.75	4.14	7.01	9.83 *	11.45 *
80	1.76 ₅	4.16	7.03	9.83 *	11.45 *
85	1.78	4.18	7.05	9.83 *	11.45 *
90	1.79	4.21	7.08	9.83 *	11.45 *
95	1.80 ₅	4.23	7.11	9.83 *	11.45 *

* Values complemented

Buffer Tables

-05- NIST standard buffers
NIST Standard (DIN 19266 : 2000-01)

°C	pH			
0				
5	1.668	4.004	6.950	9.392
10	1.670	4.001	6.922	9.331
15	1.672	4.001	6.900	9.277
20	1.676	4.003	6.880	9.228
25	1.680	4.008	6.865	9.184
30	1.685	4.015	6.853	9.144
37	1.694	4.028	6.841	9.095
40	1.697	4.036	6.837	9.076
45	1.704	4.049	6.834	9.046
50	1.712	4.064	6.833	9.018
55	1.715	4.075	6.834	9.985
60	1.723	4.091	6.836	8.962
70	1.743	4.126	6.845	8.921
80	1.766	4.164	6.859	8.885
90	1.792	4.205	6.877	8.850
95	1.806	4.227	6.886	8.833

Please note:

The actual pH values of the individual batches of the reference materials are documented in a certificate of an accredited laboratory. This certificate is supplied with the respective buffers. Only these pH(S) values shall be used as standard values for the secondary reference buffer materials. Correspondingly, this standard does not include a table with standard pH values for practical use. The table above only provides examples of pH(PS) values for orientation.

-06- HACH buffers
Nominal values: 4.01, 7.00, 10.01

°C	pH		
0	4.00	7.14	10.30
5	4.00	7.10	10.23
10	4.00	7.04	10.11
15	4.00	7.04	10.11
20	4.00	7.02	10.05
25	4.01	7.00	10.00
30	4.01	6.99	9.96
35	4.02	6.98	9.92
40	4.03	6.98	9.88
45	4.05	6.98	9.85
50	4.06	6.98	9.82
55	4.07	6.98	9.79
60	4.09	6.99	9.76
65	4.09 *	6.99 *	9.76 *
70	4.09 *	6.99 *	9.76 *
75	4.09 *	6.99 *	9.76 *
80	4.09 *	6.99 *	9.76 *
85	4.09 *	6.99 *	9.76 *
90	4.09 *	6.99 *	9.76 *
95	4.09 *	6.99 *	9.76 *

* Values complemented

Buffer Tables

-07-

WTW buffers

°C	pH			
0	2.03	4.01	7.12	10.65
5	2.02	4.01	7.09	10.52
10	2.01	4.00	7.06	10.39
15	2.00	4.00	7.04	10.26
20	2.00	4.00	7.02	10.13
25	2.00	4.01	7.00	10.00
30	1.99	4.01	6.99	9.87
37	1.99	4.02	6.98	9.74
40	1.98	4.03	6.97	9.61
45	1.98	4.04	6.97	9.48
50	1.98	4.06	6.97	9.35
55	1.98	4.08	6.98	
60	1.98	4.10	6.98	
65	1.99	4.13	6.99	
70	2.00	4.16	7.00	
75	2.00	4.19	7.02	
80	2.00	4.22	7.04	
85	2.00	4.26	7.06	
90	2.00	4.30	7.09	
95	2.00	4.35	7.12	

-08-

Hamilton Duracal buffers

°C	pH		
0	4.01	7.12	10.19
5	4.01	7.09	10.19
10	4.00	7.06	10.15
15	4.00	7.04	10.11
20	4.00	7.02	10.06
25	4.01	7.00	10.01
30	4.01	6.99	9.97
35	4.02	6.98	9.92
40	4.03	6.97	9.86
45	4.04	6.97	9.83
50	4.06	6.97	9.79
55	4.08 *	6.98 *	9.77 *
60	4.10 *	6.98 *	9.75 *
65	4.13 *	6.99 *	9.74 *
70	4.16 *	7.00 *	9.73 *
75	4.19 *	7.02 *	9.73 *
80	4.22 *	7.04 *	9.73 *
85	4.26 *	7.06 *	9.74 *
90	4.30 *	7.09 *	9.75 *
95	4.35 *	7.09 *	9.75 *

* extrapolated

The values above 50°C are not traceable to NIST.

Glossary

Asymmetry potential	The voltage which a pH sensor provides at a pH of 7. The asymmetry potential is different for each sensor and changes with age and wear.
Buffer set	Contains selected buffer solutions which can be used for automatic calibration with the Calimatic. The buffer set must be selected prior to the first calibration.
Buffer solution	Solution with an exactly defined pH value for calibrating a pH meter.
Calibration	Adjustment of the pH meter to the current sensor characteristics. The asymmetry potential and slope are adjusted. Either a one- or two-point calibration can be carried out. With one-point calibration only the asymmetry potential (zero point) is adjusted.
Calimatic	Automatic buffer recognition. Before the first calibration, the buffer set used must be activated once. The patented Calimatic then automatically recognizes the buffer solutions used during calibration.
Combination electrode	Combination of glass and reference electrode in one body.
GainCheck	Device self-test which runs automatically in the background at fixed intervals. The memory and measured-value transmission are checked. You can also start the GainCheck manually. Then a display test is also conducted and the software version displayed.

One-point calibration	Calibration with which only the asymmetry potential (zero point) is taken into account. The previous slope value is retained. Only one buffer solution is required for a one-point calibration.
Passcode	Preset four-digit number to select certain functions.
pH electrode system	A pH electrode system (pH sensor) consists of a glass and a reference electrode. If they are combined in one body, they are referred to as combination electrode.
Response time	Time from the start of a calibration step to the stabilization of the sensor potential.
Sensocheck	Sensocheck continuously monitors the glass and reference electrodes. The resulting information is indicated by the Sensoface smileys. Sensocheck can be switched off.
Sensoface	Provides information on the sensor condition. The zero point, slope, and response time are evaluated. In addition, the Sensocheck information is indicated.
Sensor slope	Is indicated in % of the theoretical slope (59.2 mV/pH at 25 °C). The sensor slope is different for each sensor and changes with age and wear.
Sensor zero point	See asymmetry potential

Glossary

Two-point calibration Calibration with which the sensor asymmetry potential (zero point) and slope are determined. Two buffer solutions are required for two-point calibration.

Zero See asymmetry potential

Warnings and Notes to Ensure Safe Operation

WARNING!

Do not disconnect equipment unless power has been switched off.

CAUTION!

Clean only with antistatic moistened cloth.

CAUTION!

Substitution of components may impair suitability for hazardous locations.

- The equipment shall be installed and protected from mechanical impact and ultraviolet (UV) sources.
- Clean only with a moistened antistatic cloth as potential electrostatic hazard may exist. Service equipment only with conductive clothing, footwear and personal grounding devices to prevent electrostatic accumulation.
- Internal grounding provisions shall be provided for field wiring. Bonding between conduit shall be provided during installation, and all exposed non-current carrying metallic parts shall be bonded and grounded.
- The equipment shall have a switch or circuit breaker in the building installation (that is in close proximity to the equipment) that is marked as the disconnect switch.
- The enclosure Type 2 is only for indoor use.
- The mains supply voltage fluctuations should not exceed -15/+10 percent of the nominal supply voltage.
- The device shall not be used in a manner not specified by this manual.

Approvals – Canada

CAUTION!

Use supply wires suitable for 30 °C / 86 °F above ambient and rated at least 250 V.

CAUTION!

Use signal wires suitable for at least 250V.

22 mA signal for error message 41, 47

A

Accessories 83

Alarm contact 53

Alarm settings 29, 52

Assembly 10

B

Buffer set selection 51

Buffer tables 90

C

Calibration 62

 Automatic calibration 64

 Calibration mode selection 50

 Cal timer interval 50

 Data entry of pre-measured electrodes 68

 Error messages 77

 Manual calibration 66

 ORP calibration 70

 Product calibration 69

Calimatic 64

Cal Info 73

“Clean” contact 56

Configuration 30

 Menu structure 31

Configuration: Alarm settings 52

Configuration: Calibration mode 50

Configuration: Limit function 54

Configuration: Output 1 34

 Output current during Error and HOLD 40

 Output current range 36

 Process variable (pH/ORP) 34

 Time constant of output filter 38

Configuration: Output 2 42

 Output current 42

 Output current during HOLD 46

 Temperature 42

- Temperature error 46
- Time constant of output filter 44
- Configuration: Rinsing probes 56
- Configuration: Temperature compensation 48
- Connection 14
- Current start / end 37, 43

D

- Device self-test 27
- Diagnostics functions 73
 - Display of calibration data 73
 - Display of last error message 73
 - Display of output currents 73
 - Display of sensor potential 73
 - Specifying the output current 74
- Display 25
- Disposal 2
- Division 2 wiring 15
- Documentation 8

E

- Error Info 73
- Error messages 75
 - Display of last error message 73
- Explosion protection 88

F

- Factory settings of parameters 58
- Front panel 24

G

- Glossary 98

H

- HOLD mode 28
 - Output signal during HOLD 41, 47
- Hysteresis 55

I

Installation 14
Intended use 7

K

Keypad 26

M

Measurement 72
Mounting plan 11

O

Operating states 79
ORP measurement
 Calibration 70
 Wiring example 21
Output filter 38, 44
Overview 9
Overview of configuration steps 32

P

Package contents 10
Panel mounting 13
Panel-mount kit 13
Parameters
 Factory settings 58
 Individual settings 60
Passcodes 107
Pipe mounting 12
Pipe-mount kit 12
Product calibration 69
Product line 83
Protective hood 12
Protective wiring 22

Q

Quickstart guides 8

R

Relay 54, 56
Relay contacts 22
Rinse contact 56
Rinsing interval 57
Rinsing probes 56
Rinsing system 57

S

Safe Operation 101
Safety information 5, 101
Self-test 27
Sensocheck 27, 52, 80
 Configuration 53
Sensoface 27, 80
Sensor connection
 VP cable 16
Sensor monitor 73
Short instructions 8
Specifications 84

T

Temperature compensation 48
Temperature measurement, configuration 43
Temperature probe adjustment 72
Terminal assignments 14
Time constant of output filter 39, 45
Trademarks 7

U

User interface 24

V

VP cable connection 16

W

Wiring examples
 ORP measurement 21
 pH measurement 18, 19, 20
 VP cable 16
 VP connection 19, 20

Calibration

Key + passcode	Menu item	Page
cal + 0000	CAL info (display of zero,slope)	73
cal + 1100	Calibration (with buffer solution)	64
cal + 1105	Product calibration	69
cal + 1015	Temp probe adjustment	72

Configuration

Key + passcode	Menu item	Page
conf + 0000	Error info (display of last error, erase)	73
conf + 1200	Configuration	30
conf + 2222	Sensor monitor (sensor potential)	73
conf + 5555	Current source 1 (specify output current)	74
conf + 5556	Current source 2 (specify output current)	74
conf + ▶ + 4321	Factory setting	58



Knick
Elektronische Messgeräte
GmbH & Co. KG

Headquarters

Beuckestraße 22 • 14163 Berlin

Germany

Phone: +49 30 80191-0

Fax: +49 30 80191-200

info@knick.de

www.knick.de

Local Contacts

www.knick-international.com

Copyright 2020 • Subject to change

This document was last updated on Nov. 16, 2020

The latest documents are available for download on our website
under the corresponding product description.

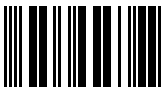

097813

TA-194.132-KNEN05

Software version: 2.x