

# P43000 TRMS

## AC High Voltage Transducer

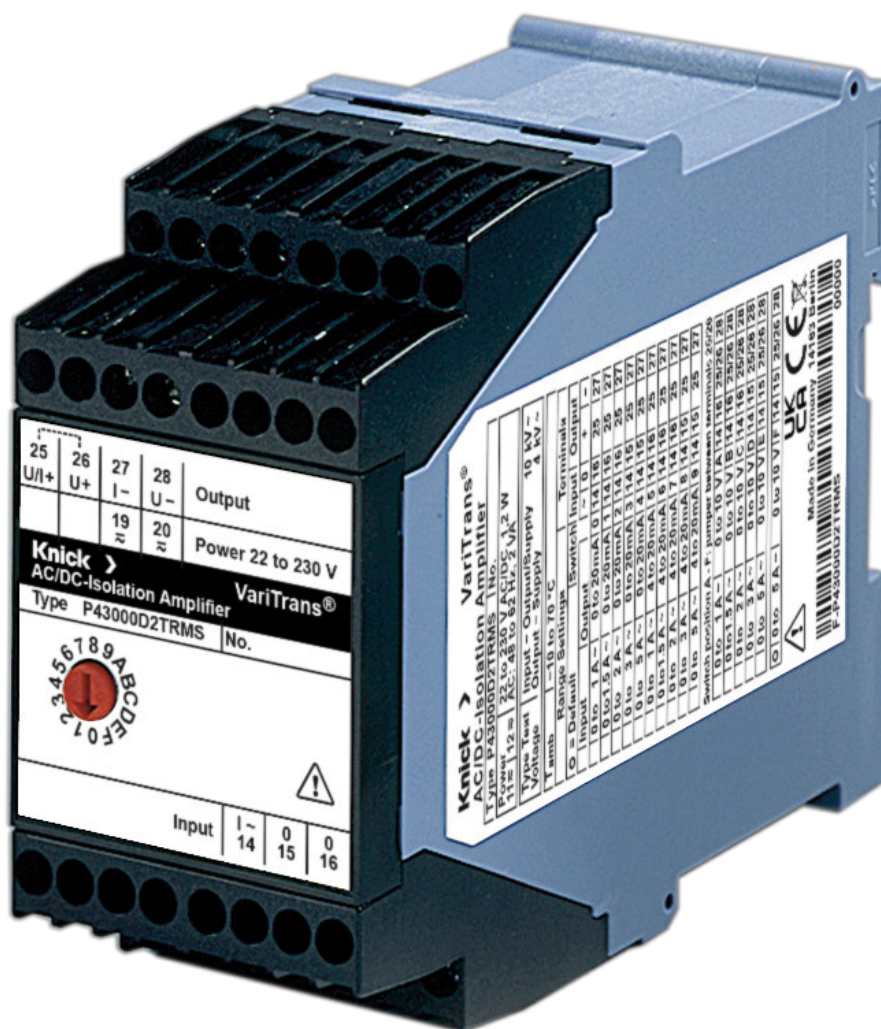

Read before installation.  
Keep for future use.



## Supplemental Directives

READ AND SAVE THIS DOCUMENT FOR FUTURE REFERENCE. BEFORE ATTEMPTING TO ASSEMBLE, INSTALL, OPERATE OR MAINTAIN THE PRODUCT, PLEASE ENSURE A COMPLETE UNDERSTANDING OF THE INSTRUCTIONS AND RISKS DESCRIBED HEREIN. ALWAYS OBSERVE ALL SAFETY INFORMATION. FAILURE TO COMPLY WITH INSTRUCTIONS IN THIS DOCUMENT COULD RESULT IN SERIOUS INJURY AND/OR PROPERTY DAMAGE. THIS DOCUMENT IS SUBJECT TO CHANGE WITHOUT NOTICE.



These supplemental directives explain how safety information is laid out in this document and what content it covers.

### Safety Chapter

This document's safety chapter is designed to give the reader a basic understanding of safety. It illustrates general hazards and gives strategies on how to avoid them.

### Warnings

This document uses the following warnings to indicate hazardous situations:

Symbol	Category	Meaning	Remark
	<b>WARNING</b>	Designates a situation that can lead to death or serious (irreversible) injury.	The warnings contain information on how to avoid the hazard.
	<b>CAUTION</b>	Designates a situation that can lead to slight or moderate (reversible) injury.	
<i>None</i>	<b>NOTICE</b>	Designates a situation that can lead to property or environmental damage.	

## Table of Contents

<b>1 Safety</b> .....	<b>4</b>
1.1 Intended Use .....	4
1.2 Personnel Requirements .....	4
1.3 Isolation .....	4
<b>2 Product</b> .....	<b>5</b>
2.1 Package Contents .....	5
2.2 Product Identification.....	5
2.3 Nameplates .....	6
2.4 Symbols and Markings.....	7
2.5 Function .....	7
2.5.1 Functional Description .....	7
2.5.2 Block Diagram .....	7
2.5.3 Application Example .....	8
2.6 Terminal assignments.....	8
2.7 Installation and Commissioning.....	9
2.8 Operation.....	10
2.9 Maintenance .....	10
2.10 Troubleshooting .....	10
2.11 Decommissioning.....	11
2.11.1 Removal .....	11
2.11.2 Return .....	11
2.11.3 Disposal.....	11
2.12 Dimension Drawings .....	12
2.13 Specifications .....	13
<b>Abbreviations</b> .....	<b>16</b>
<b>Index</b> .....	<b>17</b>

# 1 Safety

This document contains important instructions for the use of the product. Always follow all instructions and operate the product with caution. If you have any questions, please contact Knick Elektronische Messgeräte GmbH & Co. KG (sometimes hereafter referred to as “Knick”) using the information provided on the back page of this document.

## 1.1 Intended Use

The P43000 TRMS is a high voltage transducer for measuring sinusoidal and non-sinusoidal AC input currents in the range of 0 ... 100 mV to 0 ... 5 V AC. → *Application Example, p. 8*

The AC input signals are detected, galvanically isolated, and converted into standardized analog DC output signals 0 ... 20 mA, 4 ... 20 mA, or 0 ... 10 V).

The DC output signal represents the true RMS value of the AC input signal.

The P43000 TRMS is available in different versions:

- Versions with up to 16 calibrated and switchable input and output ranges. The input and output ranges are switched via an isolated rotary switch and the corresponding connection of the outputs. → *Terminal assignments, p. 8*
- Versions that are permanently set to an input and output range (without rotary switch).

The specific version of the product is stated on the nameplates attached to the product. Different properties for special versions are indicated on the nameplates. The information on the nameplates is binding.

The defined operating conditions must be observed when using this product. → *Specifications, p. 13*

**USE CAUTION AT ALL TIMES WHEN INSTALLING, USING, OR OTHERWISE INTERACTING WITH THE PRODUCT. ANY USE OF THE PRODUCT EXCEPT AS SET FORTH HEREIN IS PROHIBITED, AND MAY RESULT IN SERIOUS INJURY OR DEATH, AS WELL AS DAMAGE TO PROPERTY. THE OPERATING COMPANY SHALL BE SOLELY RESPONSIBLE FOR ANY DAMAGES RESULTING FROM OR ARISING OUT OF AN UNINTENDED USE OF THE PRODUCT.**

Comply with the information on proper storage. → *Specifications, p. 13*

See also

→ *Product Identification, p. 5*

→ *Nameplates, p. 6*

## 1.2 Personnel Requirements

The operating company shall ensure that any personnel using or otherwise interacting with the product is adequately trained and has been properly instructed.

The operating company shall comply and cause its personnel to comply with all applicable laws, regulations, codes, ordinances and relevant industry qualification standards related to product. Failure to comply with the foregoing shall constitute a violation of operating company's obligations concerning the product, including but not limited to an unintended use as described in this document.

## 1.3 Isolation

Distances to slave devices and conductive parts in the vicinity of the device must be measured according to the applied standard. The operating company must carry out, evaluate, and safeguard isolation coordination with the clearance and creepage distances and the relevant standards (e.g., EN 50124-1).

See also

→ *Insulation, p. 14*

## 2 Product

### 2.1 Package Contents

- P43000 TRMS in the version ordered
- Insertable jumper, as applicable<sup>1)</sup>
- Test Report 2.2 according to EN 10204
- Installation Guide with safety instructions

**Note:** The User Manual (this document) is published in electronic form. → *knick.de*

### 2.2 Product Identification

The different versions of the P43000 TRMS are encoded in a model designation.

The model designation can be found on the nameplate and the delivery note. → *Nameplates, p. 6*

Input	Output	Model Designation	
		Working Voltage ≤ 2.2 kV AC/DC Test Voltage 10 kV AC	Working Voltage ≤ 3.6 kV AC/DC Test Voltage 15 kV AC
0 ... 100 mA to 0 ... 5 A AC 1 to 16 ranges to customer requirements, calibrated switching	0 ... 20 mA, 4 ... 20 mA and/ or 0 ... 10 V To customer requirements, calibrated switching	P43000D2 TRMS-nnnn	–
0 ... 100 mA to 0 ... 5 A AC To customer requirements, fixed setting	0 ... 20 mA, 4 ... 20 mA and/ or 0 ... 10 V To customer requirements, fixed setting	P43000D2 TRMS-nnnn	P43100D2 TRMS-nnnn

<sup>1)</sup> Dependent on the ordered version → *Product Identification, p. 5*

### 2.3 Nameplates

The P43000 TRMS is identified by nameplates on the side and front of its housing. The information on the nameplates varies depending on the version of the product.

→ *Product Identification, p. 5*

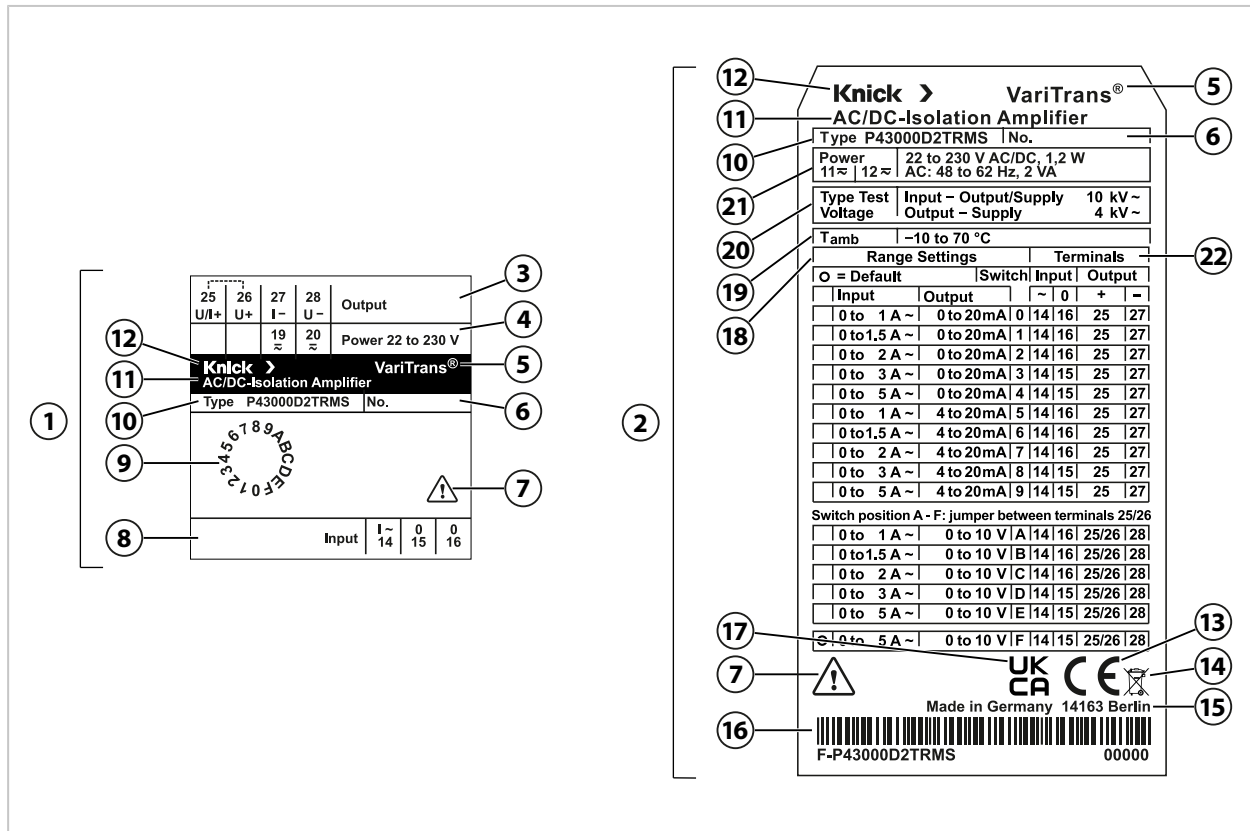

1 Nameplate, device front	12 Manufacturer
2 Nameplate, right side	13 CE mark
3 Output terminal assignments	14 WEEE mark
4 Power supply terminal assignments	15 Manufacturer's address with designation of origin
5 Product line	16 Barcode: product number, serial number, check digit
6 Product number, serial number	17 UKCA mark
7 Special conditions and danger points	18 Input and output ranges
8 Input terminal assignments	19 Permissible ambient temperature
9 Rotary encoder switch position marking	20 Type test voltage
10 Model designation	21 Power supply <sup>1)</sup>
11 Product name	22 Terminal assignments

<sup>1)</sup> The device is supplied with power from a broad-range power supply (DC or AC). → *Power Supply, p. 13*

## 2.4 Symbols and Markings



Special conditions and danger points! Observe the safety information and instructions on safe use of the product as outlined in the product documentation.



CE marking.



UK Conformity Assessed: Conformity mark for the United Kingdom (England, Scotland, and Wales)



The symbol on Knick products means that the waste devices must be disposed of separately from unsorted municipal waste.

## 2.5 Function

### 2.5.1 Functional Description

The P43000 TRMS is available in different versions. The product properties vary depending on the version. → *Product Identification, p. 5*

The sinusoidal and non-sinusoidal AC input signals are detected by the P43000 TRMS; the TRMS value is formed continuously. The TRMS value is transmitted, galvanically isolated, to the output, where it is converted into a normalized analog DC output signal. → *Block Diagram, p. 7*

An example application is directly measuring the current at high input potential.

→ *Application Example, p. 8*

The high potential of the input circuit is isolated by 3-port isolation between input, output, and power supply. → *Insulation, p. 14*

The electronic components of the P43000 TRMS are protected from environmental influences, shock, and vibration by vacuum encapsulation. → *Standards and Approvals, p. 14*

The power supply to operate the P43000 TRMS is provided by an integrated broad-range power supply. → *Power Supply, p. 13*

See also

→ *Intended Use, p. 4*

→ *Specifications, p. 13*

### 2.5.2 Block Diagram

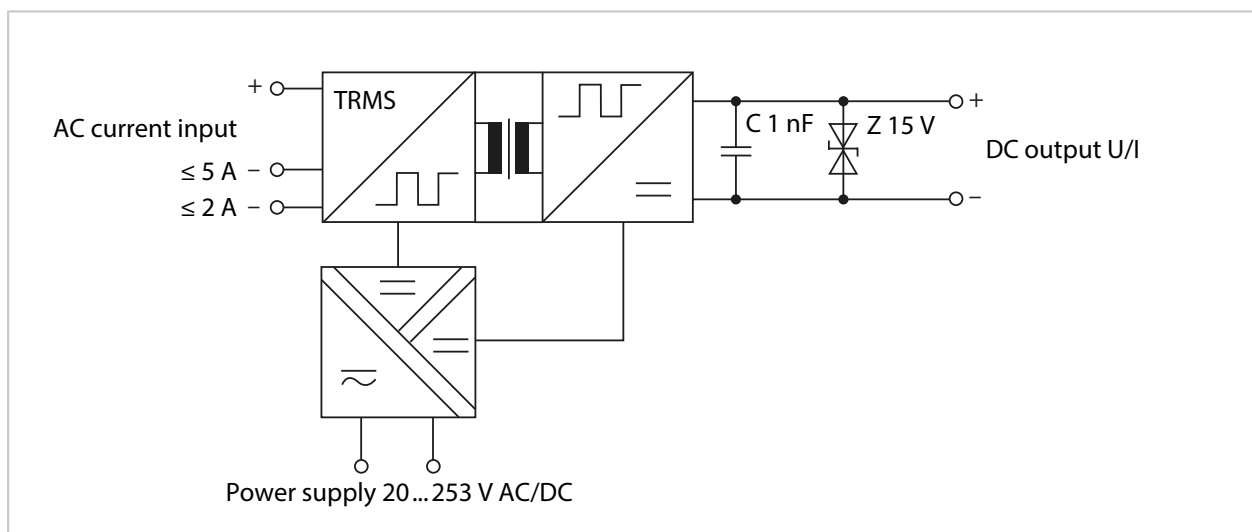

### 2.5.3 Application Example

**Note:** The figure shows an example of direct current measurement at high input potential. The specified values refer to the P43100D2 TRMS-nnnn version.

**Note:** In the figure, *Control* is used as an umbrella term for any form of further processing of the output signal.

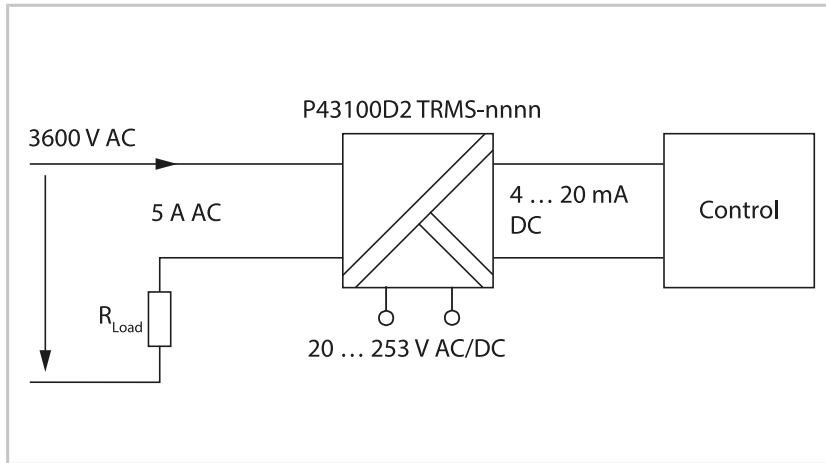

See also

→ *Product Identification, p. 5*

### 2.6 Terminal assignments

**Note:** The insertable jumper must be installed in terminals 25 and 26 for voltage output. No insertable jumper must be installed for current output. → *Installation and Commissioning, p. 9*

**Note:** The terminal assignments for the current input are dependent on the version of the P43000 TRMS. The assignments are specified on the nameplate and are available on request. → [info@knick.de](mailto:info@knick.de)

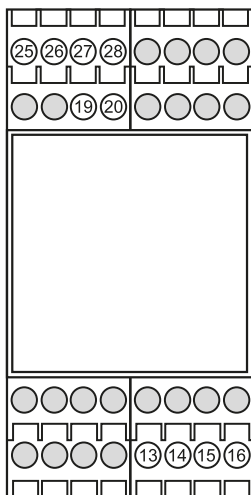

13 or 14	Input	Current AC	
<i>See information on nameplate</i>			
15 or 16	Input	Current 0	
<i>See information on nameplate</i>			
19	Power supply	AC/DC	
20	Power supply	AC/DC	
25	DC output	Current/voltage	(+)
26	DC output	Voltage	(+)
27	DC output	Current	(-)
28	DC output	Voltage	(-)

See also

→ *Nameplates, p. 6*



## 2.7 Installation and Commissioning

**⚠ WARNING! Shock potential.** Do not install the product live.

**NOTICE!** Product damage due to electrostatic discharge (ESD). Take protective measures against electrostatic discharge.

**NOTICE!** Damage to the screw terminals due to excessive tightening torque. Tighten the screw terminals with a max. torque of 0.8 Nm.

**Note:** P43000 TRMS may only be operated in a (lockable) control cabinet.

01. Disconnect the electrical system from live parts.
02. Secure the electrical system against restart.
03. Verify that the electrical system is dead.
04. Ground and short-circuit the electrical system.
05. Cover or isolate adjacent live parts with insulating materials.
06. For switchable versions: Position the rotary switch.
 

**Note:** The available input and output ranges, and the factory settings, are indicated on the nameplate on the side.
07. For current output: As necessary, remove the pre-installed insertable jumper.
 

→ *Terminal assignments, p. 8*

**Note:** Switchable versions are delivered from the factory with an installed insertable jumper (= voltage output). When switching to current output, the installed insertable jumper must be removed. Fixed-range versions are delivered with an installed insertable jumper for voltage output and without an insertable jumper for current output.
08. Snap the P43000 TRMS on to the 35 mm DIN rail.
09. Strip 8 mm of insulation from the cable ends, fit ferrules to the stranded wires. Twist pairs of cables to a point close to the connection.

Maximum cable cross-section	1 x 2.5 mm <sup>2</sup> stranded wire with ferrule
	1 x 4 mm <sup>2</sup> solid
	2 x 1.5 mm <sup>2</sup> stranded wire with ferrule
	2 x 2.5 mm <sup>2</sup> solid
Minimum cable cross-section	1 x 0.5 mm <sup>2</sup> solid or stranded wire with ferrule

10. Connect the cables for the output.
11. Connect the power supply cables.
 

**Note:** The polarity of the auxiliary power can be freely selected during connection.
12. Connect the cables for the input. The terminal assignments are specified on the nameplate.
13. Reset the electrical system to its initial state. Reverse the steps taken to ensure voltage-free operation.
14. Switch on the power supply.

**Note:** The power supply to operate the P43000 TRMS is provided by an integrated broad-range power supply (20 ... 253 V AC/DC).

See also

→ *Nameplates, p. 6*

→ *Terminal assignments, p. 8*

→ *Troubleshooting, p. 10*

## 2.8 Operation

The P43000 TRMS is designed for continuous operation. The product must be operated inside a lockable control cabinet.

The defined operating conditions must be observed when using this product. → *Specifications, p. 13*

**Note:** With switchable versions, do not switch the input and output ranges using the rotary encoder switch during operation. → *Installation and Commissioning, p. 9*

See also

→ *Product Identification, p. 5*

→ *Nameplates, p. 6*

## 2.9 Maintenance

The P43000 TRMS does not require any maintenance. Because it is fully encapsulated, it is not possible to repair the product.

## 2.10 Troubleshooting

**USE CAUTION WHEN CONDUCTING ANY TROUBLESHOOTING. FAILURE TO ABIDE BY THE REQUIREMENTS SET FORTH HEREIN MAY RESULT IN SERIOUS INJURY OR DEATH, AS WELL AS DAMAGE TO PROPERTY.**

Malfunction State	Possible Causes	Remedy
Wrong signal at output	Inputs/outputs not correctly connected, e.g., polarity reversed.	Connect inputs/outputs as specified on the nameplate.
	Selectable versions: Rotary switch not correctly positioned.	Position the rotary switch as specified on the nameplate.
	Selectable versions: For voltage output, insertable jumper not present or not correctly mounted.	Position the insertable jumper as specified on the nameplate.
No output current	P43000 TRMS is not connected to the power supply.	Check the installation and switch on the power supply.

Further troubleshooting support can be obtained from → [support@knick.de](mailto:support@knick.de).

See also

→ *Terminal assignments, p. 8*

→ *Installation and Commissioning, p. 9*

## 2.11 Decommissioning

### 2.11.1 Removal

**⚠ WARNING! Shock potential.** Do not uninstall the product live.

01. Disconnect the electrical system from live parts.
02. Secure the electrical system against restart.
03. Verify that the electrical system is dead.
04. Ground and short-circuit the electrical system.
05. Cover or isolate adjacent live parts with insulating materials.
06. Check the input of the P43000 TRMS to ensure it is dead.
07. Switch off the power supply.
08. Open the screw terminals with a screwdriver and remove the cables.
09. Pull down the housing's base latch using a screwdriver. Lift the P43000 TRMS up and off the 35 mm DIN rail.

### 2.11.2 Return

If required, send the product in a clean condition and securely packed to your local contact.

→ [knick.de](http://knick.de)

### 2.11.3 Disposal

Local codes and regulations must be observed when disposing of the product.

Customers can return their waste electrical and electronic devices.

Details on the return and environmentally friendly disposal of electrical and electronic equipment can be found in the manufacturer's declaration on our website. If you have any queries, suggestions, or questions regarding the recycling of waste electrical and electronic equipment from Knick, please send an email to → [support@knick.de](mailto:support@knick.de)

## 2.12 Dimension Drawings

**Note:** All dimensions are given in millimeters [inches].

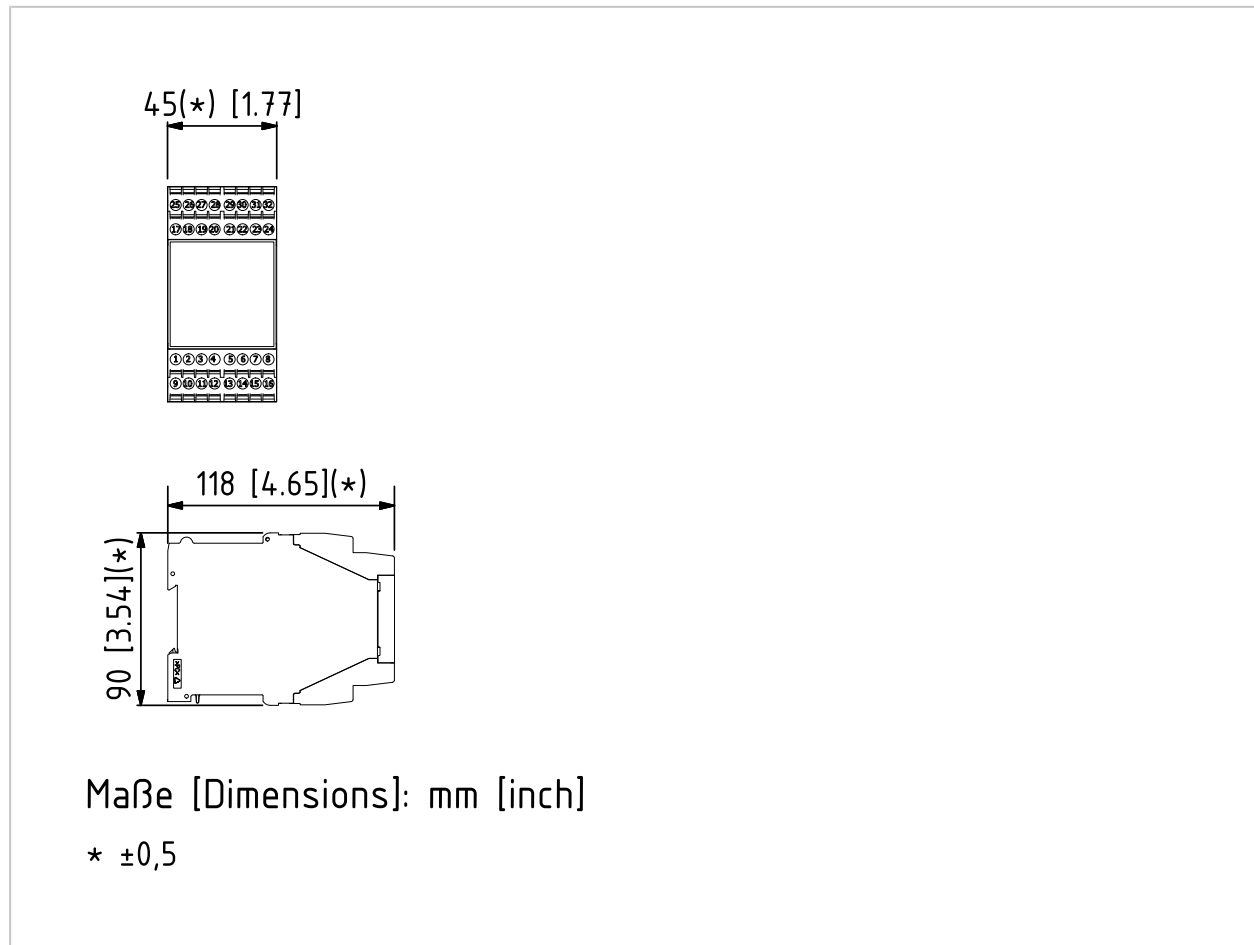

## 2.13 Specifications

### Input

Input	P43000D2 TRMS-nnnn	0 ... 100 mA to 0 ... 5 A AC 1 to 16 ranges to customer requirements, calibrated switching
	P43100D2 TRMS-nnnn	0 ... 100 mA to 0 ... 5 A AC To customer requirements, fixed setting
Rated frequency	50/60 Hz	
Frequency range	40 ... 1000 Hz (frequency $\leq$ 40 Hz on request)	
Input resistance	$< 0.6 \Omega$	
Input capacitance	Approx. 1 nF	
Overload capacity	20 % full scale (max. crest factor 8)	

### Output

Output	P43000D2 TRMS-nnnn	0 ... 20 mA, 4 ... 20 mA and/or 0 ... 10 V To customer requirements, calibrated switching
	P43100D2 TRMS-nnnn	0 ... 20 mA, 4 ... 20 mA and/or 0 ... 10 V To customer requirements, fixed setting
Offset	Up to 100 % by default	
Load	With output current:	$\leq 12 \text{ V}$ (600 $\Omega$ at 20 mA)
	With output voltage:	$\leq 10 \text{ mA}$ (1000 $\Omega$ at 10 V)
Ripple	$< 10 \text{ mV}_{\text{rms}}$	

### Transmission Behavior

Gain error	$< 0.5 \%$ full scale	
	Gain error for sinusoidal input signals (crest factor $\sqrt{2}$ ) over the frequency range of 45 ... 65 Hz	
Response time $T_{90}$	$< 150 \text{ ms}$ rising $< 300 \text{ ms}$ falling	
Influence effects (additional error)	Frequency 40 ... 1000 Hz	$< 1 \%$ of measured value (typ. 0.5 %)
	Crest factor 1 ... 3 (non-sinusoidal signals)	$< 0.5 \%$ of measured value
	Crest factor $< 3 \dots 5$	$< 1 \%$ of measured value
Common-mode rejection ratio	CMRR <sup>1)</sup> DC: approx. 150 dB AC 50 Hz: approx. 120 dB	
Temperature coefficient <sup>2)</sup>	$< 0.005 \%$ /K full scale	

### Power Supply

Power supply	22 ... 230 V AC, $\pm 10 \%$ , 48 ... 62 Hz, approx. 2 VA
	22 ... 230 V DC, $\pm 10 \%$ , approx. 1.2 W

<sup>1)</sup> Common-mode rejection ratio = differential voltage gain / common-mode voltage gain

<sup>2)</sup> Reference temperature for temperature coefficient specifications = 23 °C (73.4 °F) The average temperature coefficient is stated.

## Insulation

Galvanic isolation	3-port isolation between input, output, and power supply	
Test voltage	Calibrated switching	10 kV AC across input and output/power supply
	Fixed (P430**D2 TRMS-nnnn)	10 kV AC across input and output/power supply
	Fixed (P431**D2 TRMS-nnnn)	15 kV AC across input and output/power supply
	All types	4 kV AC across output and power supply
Insulation coordination:	For applications with high working voltages, take measures to prevent accidental contact and make sure that there is sufficient distance or insulation between adjacent devices.	
Working voltage (basic insulation) according to EN 61010-1	Calibrated switching or fixed (P430**D2 TRMS-nnnn)	Up to 2200 V AC/DC across input and output/power supply with overvoltage category III and pollution degree 2 (transient overvoltage: max. 13.5 kV)
	Fixed (P431**D2 TRMS-nnnn)	Up to 3600 V AC/DC across input and output/power supply with overvoltage category III and pollution degree 2 (transient overvoltage: max. 20 kV)
Rated insulation voltage according to EN 50124-1	Calibrated switching or fixed (P430**D2 TRMS-nnnn)	Up to 2200 V AC/DC across input and output/power supply with overvoltage category III and pollution degree 2
	Fixed (P431**D2 TRMS-nnnn)	Up to 3600 V AC/DC across input and output/power supply with overvoltage category III and pollution degree 2
Protection against electric shock	Calibrated switching or fixed (P430**D2 TRMS-nnnn)	Protective separation according to EN 61140 by reinforced insulation according to EN 61010-1. Working voltages at overvoltage category III and pollution degree 2: <ul style="list-style-type: none"> <li>• Up to 1100 V AC/DC across input and output/power supply</li> <li>• Up to 300 V AC/DC across output and power supply</li> </ul>
	Fixed (P431**D2 TRMS-nnnn)	Protective separation according to EN 61140 by reinforced insulation according to EN 61010-1. Working voltages at overvoltage category III and pollution degree 2: <ul style="list-style-type: none"> <li>• Up to 1800 V AC/DC across input and output/power supply</li> <li>• Up to 300 V AC/DC across output and power supply</li> </ul>

## Standards and Approvals

EMC <sup>1)</sup>	Product standard	EN 61326-1
	Emitted interference	Class B
	Immunity to interference	Industrial applications
Mechanical strength	IEC 61373	
RoHS conformity	According to Directive 2011/65/EU	

<sup>1)</sup> Slight deviations are possible during interference.

**Device**

MTBF <sup>1)</sup>	Approx. 96 years	
Ambient temperature	Operating <sup>2)</sup>	-10 ... 70 °C (14 ... 158 °F)
	Transport and storage	-40 ... 85 °C (-40 ... 185 °F)
Ambient conditions	Indoor use <sup>3)</sup>	
	Relative humidity 5 ... 95 %, no condensation	
	Altitude up to 2000 m (6500 ft), air pressure: 790 ... 1060 hPa <sup>4)</sup>	
Design	Modular housing with screw terminals (max. tightening torque 0.8 Nm)	
	Housing width	P43***D2 TRMS 45 mm
	Other dimensions → <i>Dimension Drawings</i> , p. 12	
Connection	M3.5 connecting screws with self-lifting terminal clamps	
	Maximum cable cross-section	1 x 2.5 mm <sup>2</sup> stranded wire with ferrule
		1 x 4 mm <sup>2</sup> solid
		2 x 1.5 mm <sup>2</sup> stranded wire with ferrule
		2 x 2.5 mm <sup>2</sup> solid
Minimum cable cross-section	1 x 0.5 mm <sup>2</sup> solid or stranded wire with ferrule	
Degree of protection	Housing IP40, terminals IP20	
Mounting	35 mm DIN rail for snap-on mounting according to EN 60715	
Weight	Approx. 350 g	

<sup>1)</sup> Mean time between failures (MTBF) according to EN 61709 (SN 29500). Requirements: stationary operation in well-kept spaces, average ambient temperature 40 °C, no aeration, continuous operation.

<sup>2)</sup> Extended operating temperature range -40 ... 75 °C (-40 ... 167 °F), short-time 85 °C (185 °F) on request

<sup>3)</sup> In enclosed areas, protected from the weather; not permissible are: water or wind-driven precipitation (rain, snow, hail etc.)

<sup>4)</sup> At low air pressure, the permissible working voltages are reduced.

## Abbreviations

CE	Conformité Européenne (European conformity)
EMC	Electromagnetic compatibility
EN	European standard
ESD	Electrostatic discharge
IP	International Protection / Ingress Protection
MTBF	Mean time between failures
TRMS	True root mean square
UKCA	United Kingdom Conformity Assessed
WEEE	Waste from electrical and electronic equipment



## Index

35 mm DIN rail 15

### A

Application example 8  
Approvals 14

### B

Base latch 11

### C

Causes, malfunctions 10  
Conformity 14

### D

Dimension drawing 12  
DIN rail 15  
Disposal 11

### E

Electrical installation 9  
Electromagnetic compatibility 14  
Electrostatic discharge 9  
Environmental damage 4  
Error elimination 10

### F

Factory setting 9

### G

Galvanic isolation 14

### I

Input 13  
Insertable jumper 9  
Insulation 14  
Introductory safety chapter 2

### J

Jumper 9

### M

M3.5 connecting screw 15  
Malfunction states 10  
Markings 7  
Model designation  
    Coding 5  
    Versions 5  
Mounting 15

### N

Nameplate  
    Device front 6  
    Side 6  
Notes on safety information 2

### O

Order code 5  
Output 13

### P

Package contents 5  
Personnel 4  
Personnel requirements 4  
Power supply 13  
Product code 5  
Property damage 4

### Q

Qualified personnel 4

### R

Range selection 9  
Recycling 11  
Remedies, malfunctions 10  
Return of waste equipment 11  
Returns 11  
Rotary switch 9

### S

Safety chapter 4  
Safety instructions 2  
Standards 14  
Supplemental directives 2  
Supply voltage 13  
Symbols and markings 7

### T

Terminal assignments 8  
Terminals 8  
Test voltage 14  
Transmission behavior 13  
Troubleshooting 10  
Type designation 5  
Typical application 8

### V

Variants 5  
Versions 5

### W

Warnings 2



**Knick**  
**Elektronische Messgeräte**  
**GmbH & Co. KG**

**Headquarters**

Beuckestraße 22 • 14163 Berlin  
Germany  
Phone: +49 30 80191-0  
Fax: +49 30 80191-200  
info@knick.de  
www.knick.de

**Local Contacts**

www.knick-international.com

Translation of the original instructions  
Copyright 2023 • Subject to change  
Version 6 • This document was published on April 20, 2023.  
The latest documents are available for download on our  
website under the corresponding product description.

TA-253.114-KNEN06



100461