

PROCESS ANALYTICS FOR POWER PLANTS



**THE ART
OF MEASURING**

PROCESS ANALYTICS FOR POWER PLANTS

In today's energy market green and renewable power is on the rise such like solar power and wind energy. Nevertheless, thermal power plants are still the backbone for the production of electricity and process steam in many countries and industries. The fuel for these power plants can be coal, oil, gas, nuclear energy or green energy such like biomass and geothermal heat. Thermal power plants operate a thermodynamic cycle where pure boiler feedwater is transformed into steam and driving turbines to produce electricity. The steam can also directly be used to heat buildings or industrial processes.

Used steam will be cooled down to form liquid condensate. Condensate is sent back to the boiler to restart the thermodynamic cycle.

Besides the boiler feedwater circuit as the core process, a thermal power plant also needs feedwater makeup systems (reverse osmosis, ion exchangers), a cooling water system, a flue gas scrubbing system and of course a waste water monitoring system.

In this brochure we describe the liquid analytic technology which is required to run a thermal power plant effectively and safely.

WHY KNICK ?

Based on high-performance and sophisticated analytical solutions for parameters pH, conductivity and DO and long-term experience in the power industry, Knick fulfills the customer's requirements with suitable products, adapted to the measurement points worldwide.

Knick's transmitters are particularly known for their reliability, longevity and intuitive operation.

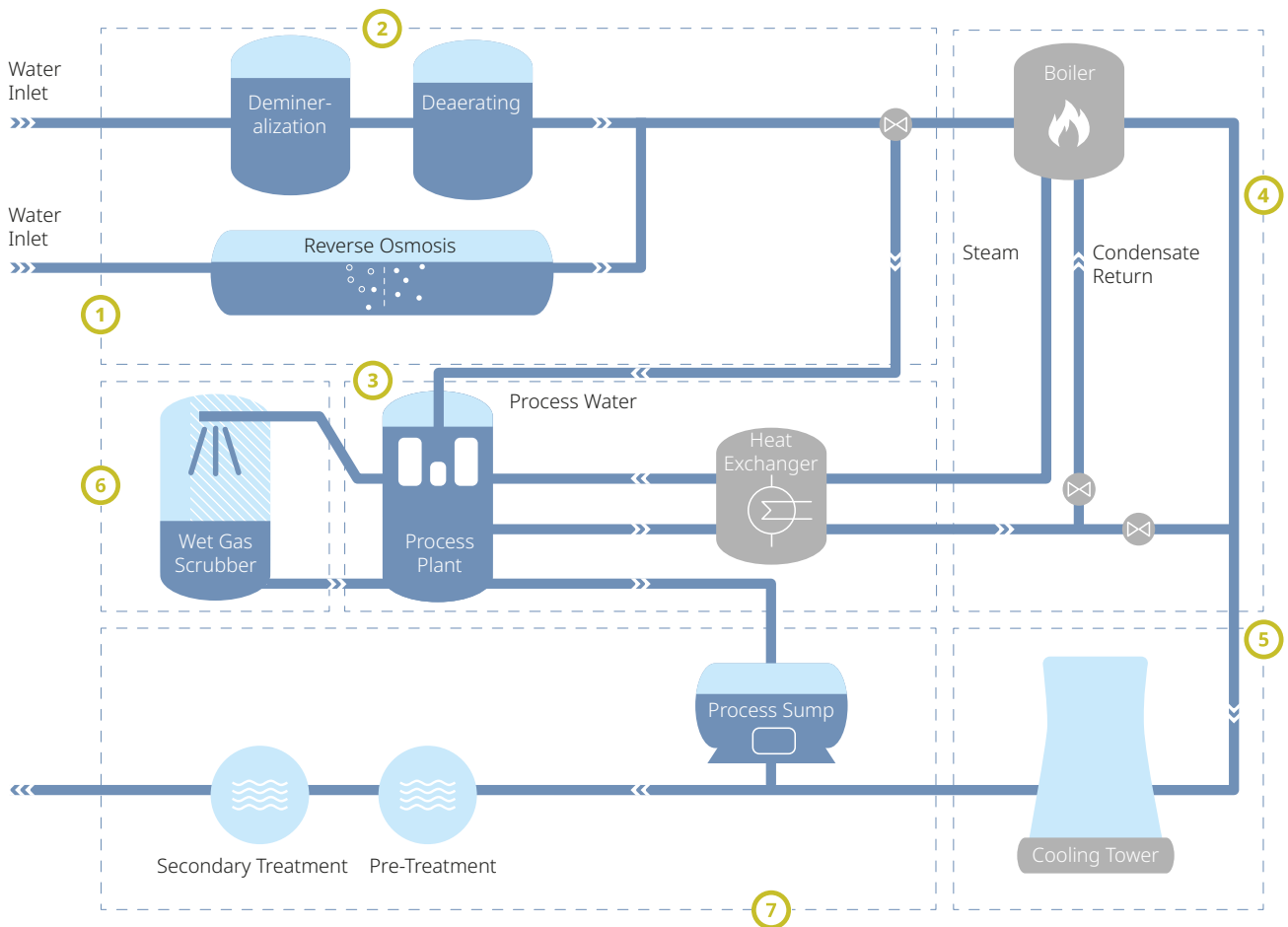

PROCESS ANALYTICS FOR POWER PLANTS PROCESSES



1

REVERSE OSMOSIS SYSTEMS

Reverse osmosis systems are used in a wide range of industrial applications for water treatment. Reverse osmosis not only filters dissolved salts from the water, but also removes contaminants and even nanoparticles (bacteria and viruses).

MORE ON PAGE 4



2

ION EXCHANGE SYSTEMS

To produce pure boiler feedwater, alternatively to a RO system, an ion exchange system can be used comprising of cation and anion vessels and a mixed bed for final polishing.

MORE ON PAGE 8



3

COMBINED CYCLE GAS TURBINES (CCGT)

Many modern power plants are operated in the combined cycle mode. In the first step, a gas fired turbine produces electricity by driving a generator.

MORE ON PAGE 10



4

BOILER FEEDWATER CIRCUITS

Boiler feedwater is the essential medium for all steam turbines. The feedwater is prepared by reverse osmosis and ion exchangers. Within the boiler it is transferred to water steam to drive the turbines.

MORE ON PAGE 14



5

COOLING WATER SYSTEMS

In a thermal power plant, an effective cooling system is needed to transform the used steam after turbine into liquid condensate (condenser)

MORE ON PAGE 18



6

FLUE GAS DESULFURIZATION

To remove the corrosive SO_2 -gas from fossil fuel or waste power plant offgas, a wet scrubber process is used. Limestone, quicklime or calcium hydroxide is used to absorb the SO_2 by forming gypsum which can be reused in building materials.

MORE ON PAGE 22



7

WATER TREATMENT SYSTEMS

Thermal power plants consume high volumes of water and they need to discharge waste water.

MORE ON PAGE 24



REVERSE OSMOSIS SYSTEMS

Reverse osmosis (RO) systems are used in a wide range of industrial applications for water treatment. Reverse osmosis not only filters dissolved salts from the water, but also removes contaminants and even nanoparticles (bacteria and viruses). The process is used to derive ultrapure water for power plants and pharmaceutical production, as well as for treating potable water and for desalination.

Monitoring reverse osmosis systems requires inline measurement of the pH value, ORP and conductivity. Adding a variety of chemicals during the process prevents organic or inorganic deposits from building up on the osmosis membrane. Imprecise dosing can lead to membrane damage and biological growth as well.

As a consequence, systems must be shut down and cleaned extensively. The ability to measure micro conductivity values and the setpoint deviation of ORP and pH values is a key prerequisite for extending membrane service life and saving the cost of premature replacement. The amount of chemicals such as chlorine and sodium bisulfite used can be significantly reduced when conductivity, pH and ORP are precisely recorded.

Memosens sensors are precalibrated in the laboratory, eliminating the need for complicated on-site calibration under difficult conditions. As soon as the sensors are connected to a Knick Memosens transmitter, their calibration data are automatically transferred to the device.

In a power plant, the reverse osmosis system is used to produce the boiler feed water for steam production. Below you find a schematic of a typical boiler feedwater system based on RO technology. pH, ORP and conductivity need to be monitored after each RO step and in each RO train in the main header (see indication in schematic).

WHY KNICK ?

Knick's conductivity sensor SE604 is the only sensor with removable outer electrodes for easy cleaning and handling.

The recommended pH sensor SE558 has an extra electrolyte reservoir for accurate and stable measurements in samples with low conductivity.

Fulllest flexibility with Knick's transmitters (e.g. Stratos Multi): one system for all measurement points with flexible parameter configuration.

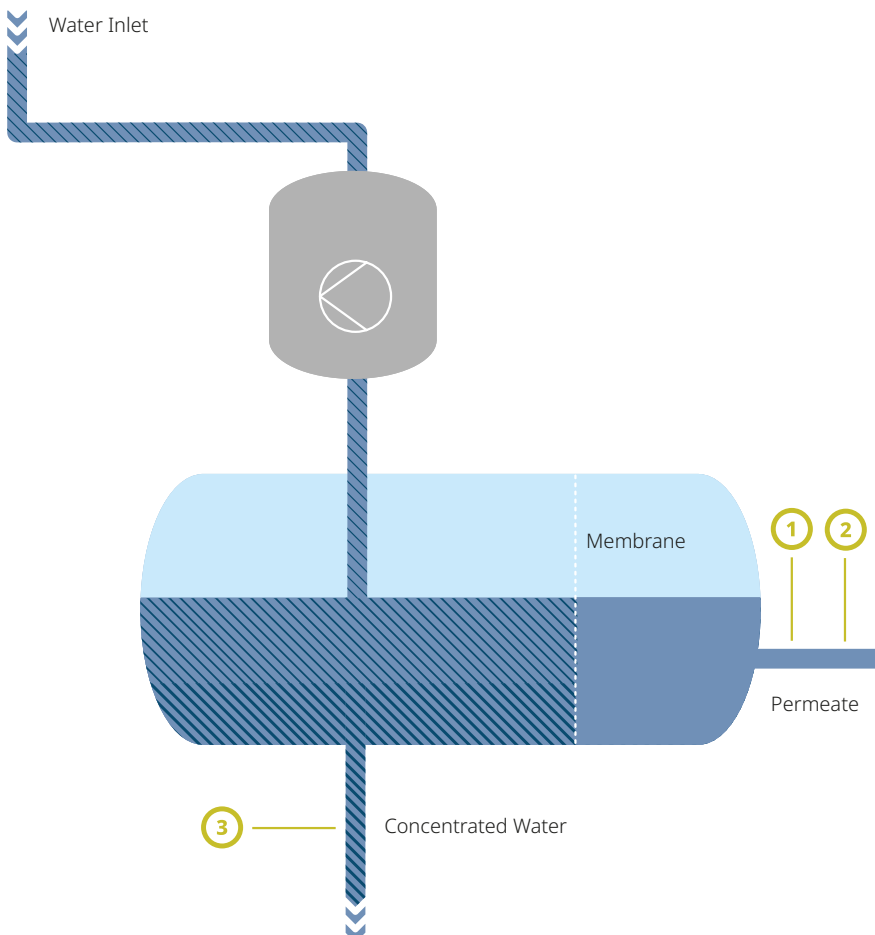

- ① pH Loop to Check Permeate Quality
- ② Cond Loop to Check on Module Leakage
- ③ ORP Loop to Check Concentrated Water

REVERSE OSMOSIS SYSTEMS APPLICATIONS

1 pH Loop to Check Permeate Quality

PRODUCT

Stratos Multi



FEATURES

- Dual channel any parameter
- Advanced diagnostics
- Memosens technology
- NAMUR status indications
- Hart, ProfiNet and EtherNet/IP communication options

CUSTOMER BENEFIT

- Small footprint due to double channel, split display
- Sensor diagnostics and alarm indication and transmission

PRODUCT

pH Sensor SE558



FEATURES

- Designed for low conductivity
- Viscous gel filling
- Inbuilt KCl reservoir
- 3 x ceramic junction

CUSTOMER BENEFIT

- No external KCl reservoir needed
- No contact problems due to Memosens technology

PRODUCT

Flow-Through Fitting ARF201



FEATURES

- Robust flow through fitting in polypropylene
- Various sensor and process connections

CUSTOMER BENEFIT

- Accurate measurement
- Suitable for moderate temperatures and high pressures

2 Cond Loop to Check on Module Leakage

PRODUCT

Stratos Multi



FEATURES

- Dual channel any parameter
- Advanced diagnostics
- Memosens technology
- NAMUR status indications
- Hart, ProfiNet and EtherNet/IP communication options

CUSTOMER BENEFIT

- Small footprint due to double channel, split display
- Sensor diagnostics and alarm indication and transmission

PRODUCT

2-Electrode Conductivity Sensor SE604



FEATURES

- 0.04 ... 1,000 µS/cm
- Stainless steel 1.4435, PEEK insulator
- Up to 120 °C and 25 bar
- Available with Memosens technology
- Easy cleanability due to removable outer electrode

CUSTOMER BENEFIT

- Lowest measuring range
- Suitable for high pressures and temperatures
- Remote calibration by Memosens protocol

PRODUCT

Flow-Through Fitting ARF200



FEATURES

- Robust flow through fitting in stainless steel
- Various sensor and process connections

CUSTOMER BENEFIT

- Accurate measurement
- Suitable for high temperatures and high pressures

REVERSE OSMOSIS SYSTEMS APPLICATION

3 ORP Loop to Check Concentrated Water

PRODUCT

Stratos Multi



FEATURES

- Dual channel any parameter
- Advanced diagnostics
- Memosens technology
- NAMUR status indications
- Hart, ProfiNet and EtherNet/IP communication options

CUSTOMER BENEFIT

- Small footprint due to double channel, split display
- Sensor diagnostics and alarm indication and transmission

PRODUCT

ORP Sensor SE565



FEATURES

- Sensor element: platinum plate
- Up to 135 °C, up to 6 bar
- Ceramic junction
- Viscous gel filling
- For aggressive media
- Memosens technology

CUSTOMER BENEFIT

- Long lifetime even in harsh conditions
- Remote calibration
- Sensor/cable connection can be submerged in water (Memosens)

PRODUCT

Flow-Through Fitting ARF200



FEATURES

- Robust flow through fitting in stainless steel
- Various sensor and process connections

CUSTOMER BENEFIT

- Accurate measurement
- Suitable for high temperatures and high pressures

PRODUCT HIGHLIGHT

STRATOS MULTI

The latest generation of our proven Stratos process analyzers for Memosens, digital, and analog sensors.

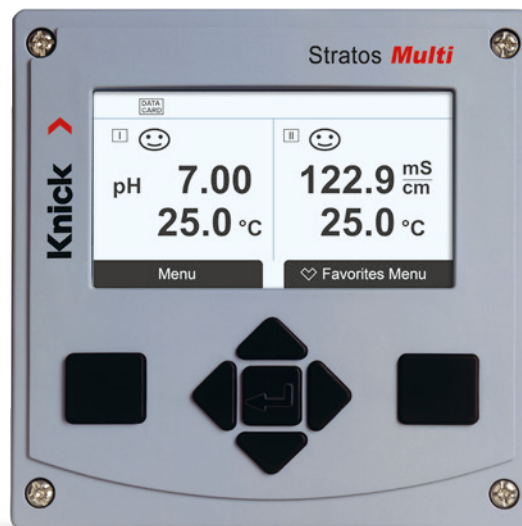

OPTIMIZED MAINTENANCE INTERVALS

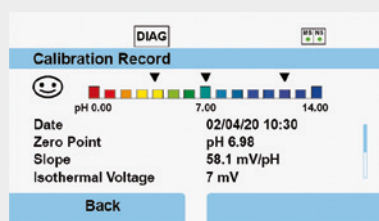

Efficient adjustment of calibration intervals using the adaptive calibration timer. Another new feature, the load diagram, delivers information on which extreme values each sensor was exposed to.

FACTS

- Multiparameter functionality provides flexibility.
- High-resolution display for an intuitive, self-explanatory user interface.
- Advanced Process Control with Ethernet interfaces.

SMART DIAGNOSTICS MANAGEMENT

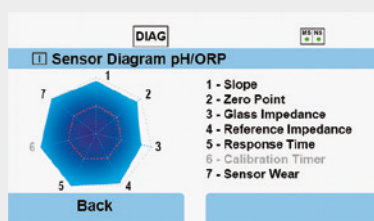

At a glance, users receive information on the sensor's condition and on the remaining lifetime of the connected sensors.

In addition, a sensor diagram facilitates sensor monitoring. All the relevant sensor data, such as zero point, slope, service life, calibration timer, impedance, and response times are clearly presented.

SEAMLESS DATA RECORDING

Calibration data and power supply status as well as outage and maintenance messages can be recorded with the logbook and are shown directly on the display. All data can be saved on the Data Card.

VISUAL DISPLAY OF SENSOR AND DEVICE CONDITIONS

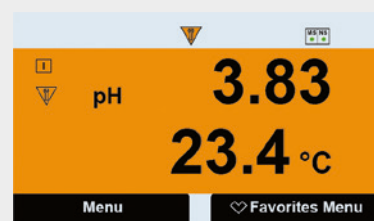

The color-coded user interface allows you to quickly ascertain the sensor condition. The display fields have different background colors based on the NE 107 status messages, so users can identify sensor conditions and device modes at a glance. The sensor monitoring system indicates the sensor's maintenance needs using the established Sensoface and can also be configured with messages to that effect.



ION EXCHANGE SYSTEMS

To produce pure boiler feedwater, alternatively to a RO system, an ion exchange system can be used comprising of cation and anion vessels and a mixed bed for final polishing. Steel pressure vessels filled with ion exchanger resins absorb all salt components (cations and anions) from the feed water. The ion exchanger resins need to be regenerated using strong acidic and caustic solutions.

Specific conductivity and cation conductivity needs to be measured after each vessel (see indication in schematic). To reduce overall cost and downtime for regeneration, these measurements are mandatory to run the system efficiently. Amount of chemicals used and production of wastewater can be minimized by optimized control.

WHY KNICK ?

Knick's conductivity sensor SE604, recommended for this application, is the only sensor with removable outer electrodes for easy cleaning and handling.

SI/SF (System Integrators/System Fabricators) and plant manufacturers appreciate our reliable, sophisticated and accurate solutions.

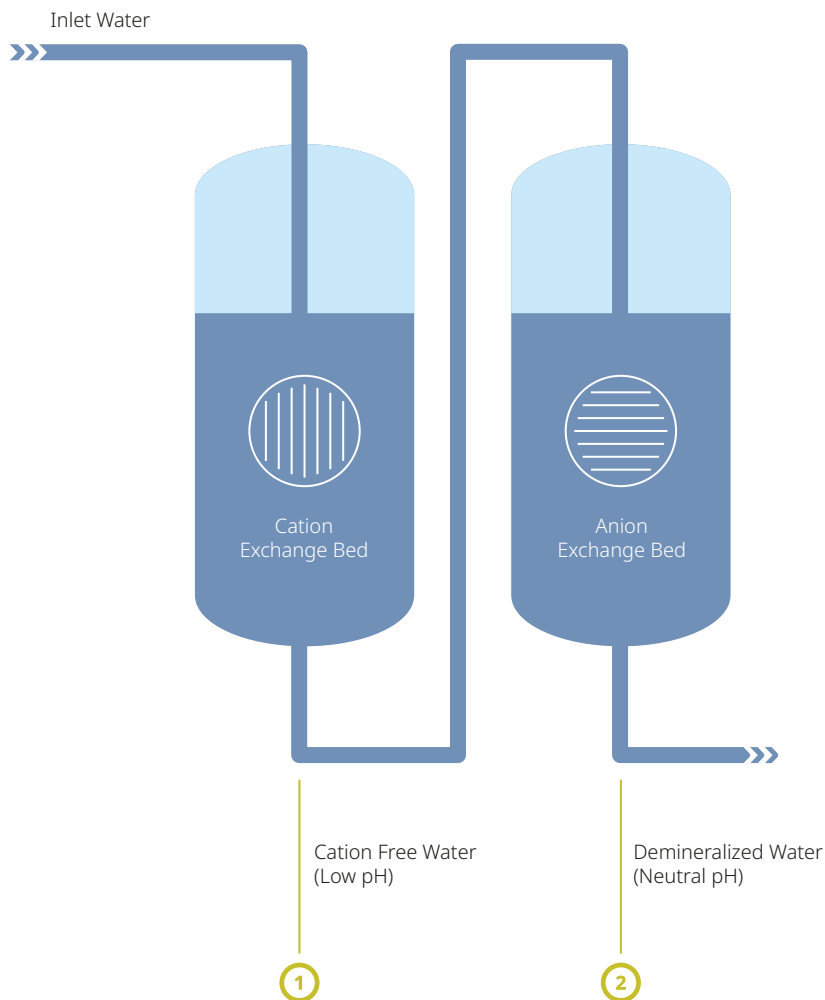

APPLICATIONS

- 1 Conductivity Measurement after Cation Exchanger
- 2 Conductivity Measurement after Anion Exchanger

ION EXCHANGE SYSTEMS APPLICATIONS

1 2 Conductivity Measurement after Cation / Anion Exchanger

PRODUCT

Stratos MS



FEATURES

- Memosens technology
- Multiparameter

CUSTOMER BENEFIT

- Low cost standard transmitter for many applications

PRODUCT

2-Electrode
Conductivity
Sensor
SE604



FEATURES

- 0.04 ... 1,000 $\mu\text{S}/\text{cm}$
- Stainless steel 1.4435, PEEK insulator
- Up to 120 °C and 25 bar
- Available with Memosens technology
- Easy cleanability due to removable outer electrode

CUSTOMER BENEFIT

- Lowest measuring range
- Suitable for high pressures and temperatures
- Remote calibration by Memosens protocol

PRODUCT

Flow-Through
Fitting
ARF200



FEATURES

- Robust flow through fitting in stainless steel
- Various sensor and process connections

CUSTOMER BENEFIT

- Accurate measurement
- Suitable for high temperatures and high pressures

PRODUCT HIGHLIGHT

STRATOS MS

The digital multiparameter device to measure pH, ORP, conductivity (conductive/inductive) or oxygen. With Memosens technology.

AFFORDABLE MULTI-PARAMETER TRANSMITTER

With the Stratos MS, Knick is now offering a low-cost, purely digital version of its Stratos analyzers that can be configured to measure pH value, ORP, conductivity (conductive or inductive) and dissolved oxygen. Designed for digital Memosens sensors.

UNIQUE USER INTERFACE

The self-explanatory user interface guarantees comfortable and intuitive handling.

2-COLOR BACKLIT DISPLAY

The large, high-contrast LC display simultaneously indicates measured values and temperature in plain text as well as measurement symbols. In normal measuring mode the



display is backlit white. The alarm status has a particularly noticeable red display color and is also signaled by flashing display values. Invalid inputs or false passcodes cause the entire display to flash red so that operating errors are significantly reduced. Internationally recognizable icons provide operating information and draw attention to unusual operating states.



COMBINED CYCLE GAS TURBINES (CCGT)

Many modern power plants are operated in the combined cycle mode. In the first step a gas turbine produces electricity. The hot off gas from the gas turbine is fed into a conventional thermal boiler system with another steam turbine resulting in a very good overall efficiency. In the below schematic, the measuring locations for pH, Cond and DO are highlighted.

WHY KNICK ?

Due to many years of experience in process analysis in the energy industry and a wide range of suitable products, such as flow-through fittings, compact transmitters for DIN-Rail and multi-purpose use of the same equipment, Knick is able to adapt simple and cost-effective solutions to the requirements of measuring points.

- EPRI = Electric Power Research Institute/USA
- ASME = American Society of Mechanical Engineers/USA
- NEM = NEM Energy (Siemens)/The Netherlands
- VGB = German organization of power plant operators
- TÜV = German technical approval organization
- (*) = if cation conductivity is more than 0.2 µS/cm for several days, then oxygen

BOILER FEEDWATER LIMITS ACCORDING TO EPRI, ASME, NEM, VGB AND TÜV GUIDELINES

PARAMETER	EPRI	ASME	NEM	VGB/TÜV
pH	9.2-9.6	8.3-9.6	9.0-10.0	9.0-10.0
cation conductivity	< 0.2 µS/cm	< 0.2 µS/cm	< 0.2 µS/cm	< 0.2 µS/cm
dissolved oxygen	< 10 ppb	2 ppb < DO < 7 ppb	5 ppb < DO < 20 ppb	< 100 ppb (*)

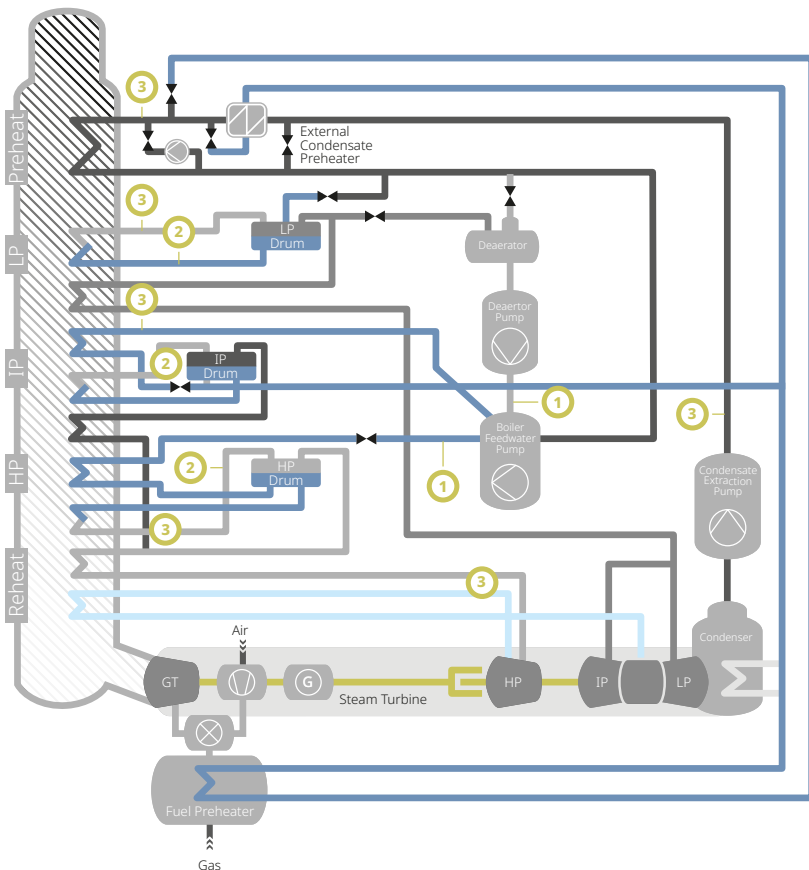

APPLICATIONS

- 1 Check DO after Deaerator and Boiler Feed Water Pump
- 2 Check pH and Cond in boiler water (LP Drum, IP Drum, HP Drum)
- 3 Check Cond in Steam and Condensate (LP, IP, HP cycle, condensate extraction, preheat and preheat cycle)

COMBINED CYCLE GAS TURBINE (CCGT) APPLICATION

1 Check DO after Deaerator and Boiler Feed Water Pump

PRODUCT

MemoRail



FEATURES

- Compact design and cost saving
- Single and dual channel
- MemoSuite technology
- Optional Modbus output

CUSTOMER BENEFIT

- Cost effective solution for many measuring locations
- Easy remote calibration by using the MemoSuite software

PRODUCT

Optical Oxygen Sensor SE740



FEATURES

- Luminescence technology (optical)
- Range: 4 ppb to 25 ppm
- Digital communication to meter
- Maintenance by basic cleaning or replacement of cap
- No electrolyte required

CUSTOMER BENEFIT

- High accuracy
- Low maintenance
- Easy to calibrate

PRODUCT

Flow-Through Fitting ARF200



FEATURES

- Robust flow through fitting in stainless steel
- Various sensor and process connections

CUSTOMER BENEFIT

- Accurate measurement
- Suitable for high temperatures and high pressures

PRODUCT HIGHLIGHT

MEMORAIL

The Essence of Measuring.



MAXIMUM PERFORMANCE IN A MINIMUM OF SPACE

MemoRail is the first genuinely compact, digital analyzer for measuring pH values, ORP, conductivity, oxygen and temperature with Memosens sensors. Two analog active / passive 4 to 20 mA outputs supply the measured values for the process value and temperature to the process control system or a PLC.

PLUG & MEASURE

MemoRail is immediately ready for measurement on connecting a pre-calibrated Memosens sensor. "Used"

sensors can simply be replaced.

MEMOSENS

Optimum availability of the point of measurement is achieved by using precalibrated sensors with contactless Memosens technology.

Calibration is no longer carried out on site but under reproducible conditions in the laboratory with the new MemoSuite software tool. Individual sensor data are always directly assigned to each Memosens sensor.

COMBINED CYCLE GAS TURBINE (CCGT) APPLICATION

2 Check pH and conductivity in boiler water (LP Drum, IP Drum, HP Drum)

PRODUCT

MemoRail



FEATURES

- Compact design and cost saving
- Single and dual channel
- Memosens technology
- Optional Modbus output

CUSTOMER BENEFIT

- Cost effective solution for many measuring locations
- Easy remote calibration by using the MemoSuite software

PRODUCT

pH Sensor
SE558



FEATURES

- Designed for low conductivity
- Viscous gel filling
- Inbuilt KCl reservoir
- Memosens technology
- 3 x ceramic junction

CUSTOMER BENEFIT

- No external KCl reservoir needed
- No contact problems due to Memosens technology

PRODUCT

2-Electrode
Conductivity
Sensor
SE604



FEATURES

- 0.04 ... 1,000 $\mu\text{S}/\text{cm}$
- Stainless steel 1.4435, PEEK insulator
- Up to 120 °C and 25 bar
- Available with Memosens technology
- Easy cleanability due to removable outer electrode

CUSTOMER BENEFIT

- Lowest measuring range
- Suitable for high pressures and temperatures
- Remote calibration by Memosens protocol

PRODUCT

Flow-Through
Fitting
ARF200



FEATURES

- Robust flow through fitting in stainless steel
- Various sensor and process connections

CUSTOMER BENEFIT

- Accurate measurement
- Suitable for high temperatures and high pressures

PRODUCT HIGHLIGHT

FLOW-THROUGH FITTINGS

For applications in a bypass.

- Made of stainless steel or plastic with a large number of sensor connections.
- Modular design with flanged or threaded process connections.
- Also for high temperatures/pressures.
- Impermeable and therefore also suitable for measuring trace oxygen.

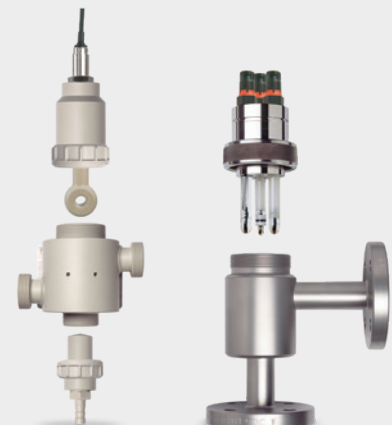

COMBINED CYCLE GAS TURBINE (CCGT) APPLICATION

3 Check Cond in Steam and Condensate (LP, IP, HP cycle, condensate extraction, preheat and reheat cycle)

PRODUCT

MemoRail



FEATURES

- Compact design and cost saving
- Single and dual channel
- Memosens technology
- Optional Modbus output

CUSTOMER BENEFIT

- Cost effective solution for many measuring locations
- Easy remote calibration by using the MemoSuite software

PRODUCT

2-Electrode Conductivity Sensor SE604



FEATURES

- 0.04 ... 1,000 $\mu\text{S}/\text{cm}$
- Stainless steel 1.4435, PEEK insulator
- Up to 120 °C and 25 bar
- Available with Memosens technology
- Easy cleanability due to removable outer electrode

CUSTOMER BENEFIT

- Lowest measuring range
- Suitable for high pressures and temperatures
- Remote calibration by Memosens protocol

PRODUCT

Flow-Through Fitting ARF200



FEATURES

- Robust flow through fitting in stainless steel
- Various sensor and process connections

CUSTOMER BENEFIT

- Accurate measurement
- Suitable for high temperatures and high pressures

PRODUCT HIGHLIGHT

MEMOVIEW AND PORTAVO

Mobile tool for the contactless, on-site visualization of Knick Memosens measuring points without a display.



MOBILE CHECK OF SENSOR AND MEASURING POINT. WITHOUT PROCESS INTERRUPTION

With MemoView, Memosens online measuring points without on-site display (e.g., in conjunction with MemoRail) can be queried contactless during operation. Users simply push MemoView onto the Memosens sensor connection and all the values and sensor data are displayed on the Portavo mobile analyzer.

COMPREHENSIVE COMMUNICATION

With the Portavo mobile process analyzer, sensor data and up to 10,000 measured values can be recorded and saved directly via MemoLog. This makes it possible to conveniently manage the recorded values everywhere.

OPTIMIZED MAINTENANCE

MemoView is ideal for on-site maintenance and read out of calibration data. And in systems with Protos and Stratos Multi transmitters, MemoView can be used to check the sensors on site.



BOILER FEEDWATER CIRCUITS

Boiler feedwater is the essential medium for all steam turbines. The feedwater is prepared by reverse osmosis and ion exchangers. Within the boiler, it is transferred to water steam to drive the turbines. Feedwater must be very pure to prevent any corrosion and incrustations within the turbine. A damage of the turbine is the most cost intensive accident within a conventional power plant.

Criteria for the purity of the feedwater/condensate are conductivity, pH, and dissolved oxygen. In the schematic you find the typical measuring locations for dissolved oxygen, specific conductivity (SC), cation conductivity (CC), degassed acid conductivity (DAC) and pH. If the condensate return does not meet the specification, it needs to be discharged. pH and conductivity are the essential parameters of the boiler feedwater before entering the turbine.

In most cases, dual conductivity measurements are used to calculate pH and specific conductivity. pH and conductivity are the essential parameters of condensate (after passing the turbine). Usually dual channel conductivity measurements are used to calculate pH, specific conductivity (SC), cation conductivity (CA) and degassed acid conductivity (DAC).

Since CO₂ from the air may enhance the conductivity, the degassed conductivity is an important criterion for the purity.

WHY KNICK?

The challenge of the application is the low ion concentration and typically amine is dosed for avoiding corrosion. Amine dosing based on conductivity is not easily possible – pH monitoring is also required, which is difficult due to the low ion content.

Therefore, a better approach is to accurately calculate pH based on the dual conductivity measurement. Stratos Multi is the perfect fit for this application, as the dual conductivity measurement can easily be combined with a DO measurement for ideal process monitoring.

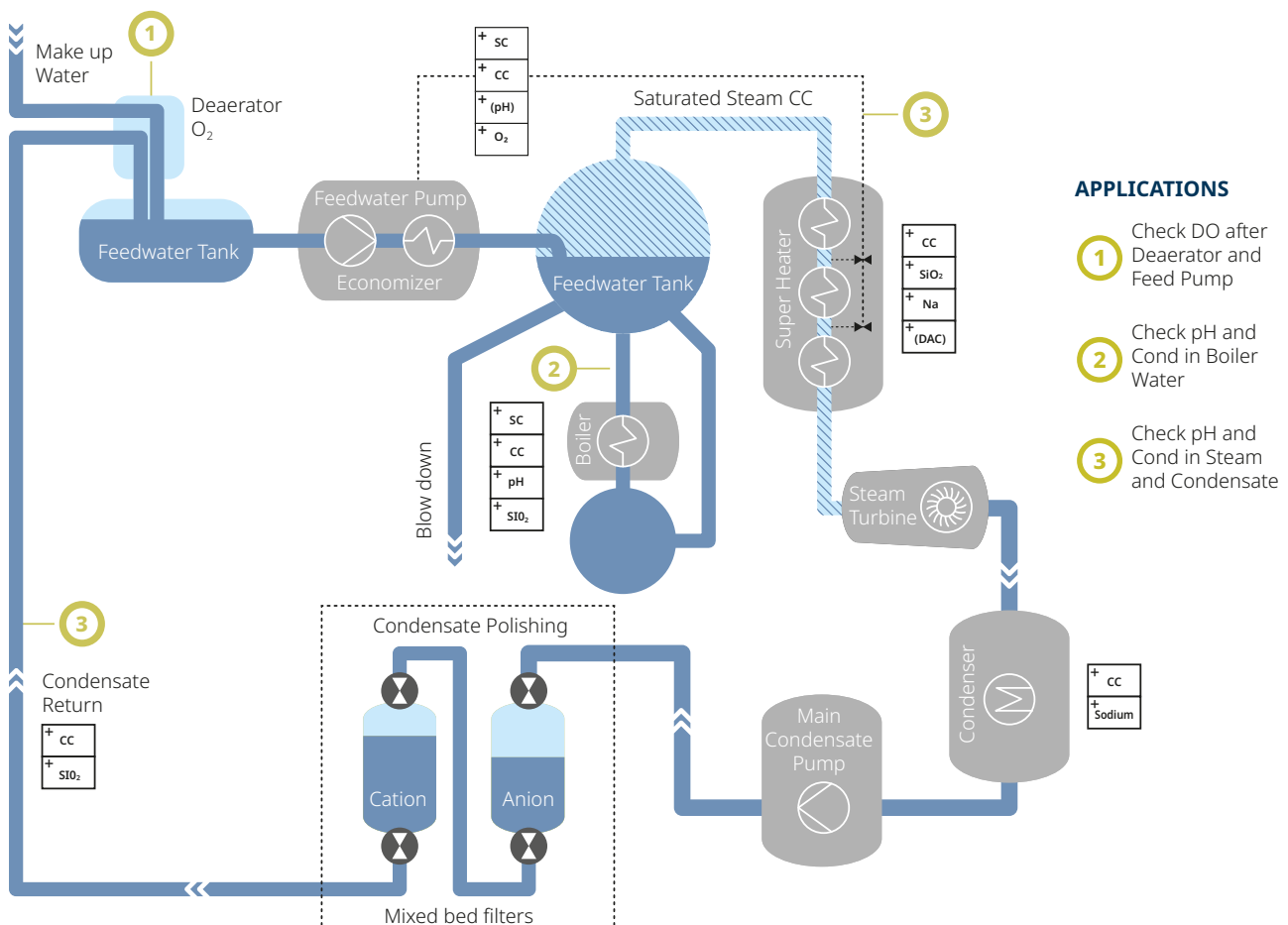

APPLICATIONS

- 1 Check DO after Deaerator and Feed Pump
- 2 Check pH and Cond in Boiler Water
- 3 Check pH and Cond in Steam and Condensate

BOILER FEEDWATER CIRCUIT APPLICATION

1 Check DO after Deaerator and Feed Pump

PRODUCT

Stratos Multi



FEATURES

- Modern easy to operate transmitter in a lot of languages
- Dual input for conductivity to calculate pH in addition to conductivity
- Option for a 3rd DO sensor
- 3 measuring points in one
- Modern fieldbus Communication

CUSTOMER BENEFIT

- Cost effective solution 3 in one
- Easy remote calibration by using the MemoSuite software
- HART, ProfiNet, Ethernet/IP with predictive maintenance.

PRODUCT

Optical Oxygen Sensor SE740



FEATURES

- Luminescence technology (optical)
- Range: 4 ppb to 25 ppm
- Digital communication to meter
- Maintenance by basic cleaning or replacement of cap
- No electrolyte required

CUSTOMER BENEFIT

- High accuracy
- Low maintenance
- Easy to calibrate

PRODUCT

Flow-Through Fitting ARF200



FEATURES

- Robust flow through fitting in stainless steel
- Various sensor and process connections

CUSTOMER BENEFIT

- Accurate measurement
- Suitable for high temperatures and high pressures



In bigger power plants all quality measurements connected to boiler, boiler feed water and steam condensate are usually centralized monitored in large analytical shelters (Source: Dr. Thiedig GmbH & Co KG, Berlin).

BOILER FEEDWATER CIRCUIT APPLICATIONS

2 3 Check pH and Conductivity in Boiler Water or Condensate

PRODUCT

Stratos Multi



FEATURES

- Modern easy to operate transmitter in a lot of languages
- Dual input for conductivity to calculate pH in addition to conductivity
- Option for a 3rd DO sensor
- 3 measuring points in one
- Modern fieldbus Communication

CUSTOMER BENEFIT

- Cost effective solution 3 in one
- Easy remote calibration by using the MemoSuite software
- HART, ProfiNet, Ethernet/IP with predictive maintenance.

PRODUCT

2x2-Electrode Conductivity Sensor SE604



FEATURES

- 0.04 ... 1,000 $\mu\text{S}/\text{cm}$
- Stainless steel 1.4435, PEEK insulator
- Up to 120 °C and 25 bar
- Available with Memosens technology
- Easy cleanability due to removable outer electrode

CUSTOMER BENEFIT

- Lowest measuring range
- Suitable for high pressures and temperatures
- Remote calibration by Memosens protocol

PRODUCT

Flow-Through Fitting ARF200



FEATURES

- Robust flow through fitting in stainless steel
- Various sensor and process connections

CUSTOMER BENEFIT

- Accurate measurement
- Suitable for high temperatures and high pressures

PRODUCT HIGHLIGHT

PROTOS

The modular premium transmitter for all requirements. Versatile. Expandable. Ensuring Process Safety.



The Protos premium transmitter is a flexible, 4-wire device for the following process variables: pH, ORP, conductivity and oxygen. For monitoring and controlling processes even in the most complex applications – also in hazardous areas. With modular hardware and firmware concept.

RETROFITS POSSIBLE, FUTURE-PROOF

Protos features a unique modular design and freely accessible wiring with a clear layout. The option for easy retrofitting and upgrading ensure planning security today and in the future. Different Ethernet and Fieldbus modules enable digital communication and seamless integration into automation systems.

WIDE SENSOR SELECTION

Protos is the only process analysis system that can be flexibly combined with Memosens and other digital or analog sensors – in multi-channel mode as well. With Memosens technology, up to 4 measuring channels can be implemented in parallel.

STATUS MESSAGES ACC. TO NE 107

All status messages for maintenance requests, failure, out of specification, and function check (HOLD) are output as specified in NE 107.



RELIABLE AND SAFE THANKS TO MEMOSENS TECHNOLOGY

Digital sensors with inductive signal transmission – contactless sensor couplings ensure the reliable analysis of liquid in all environments. Sensors that are precalibrated in the laboratory deliver maximum availability and reduced maintenance efforts at the point of measurement. Sensors can be replaced on site in just a matter of seconds

- Perfect galvanic isolation
- Fully resistant to moisture, dirt, corrosion, and interference potentials
- Easy to use, even under harsh conditions
- Up to 100m cable length

FACTS AND FIGURES

- Stainless steel design with corrosion-proof powder coating for harsh industrial areas
- Universal broad-range power supply 24 ... 230 V AC/DC
- Rugged; can also be used outdoors (with IP 65 protection and UV resistance)
- Panel, wall or post/pipe mounting
- High-contrast graphic LC display
- Memory card concept for data recording, firmware updates, and Audit Trail
- Freely combinable measuring, control, and communication modules



COOLING WATER SYSTEMS

In a thermal power plant, an effective cooling system is needed to transform the used steam after turbine into liquid condensate (condenser). A complex chemical water treatment is required for cost-effective operation of the cooling system. Cooling towers are expensive in investment and running cost and need to be maintained properly in order to avoid costly shutdowns of the complete power plant. The main problems are scaling, corrosion and biological growth from algae and bacteria.

Application 1:

Acid is added to dissolve carbonates before they can block the system, controlled by pH measurement.

Application 2:

A biocide (e.g. hypochlorite) is added to prevent algae and bacteria growth which will block the system, controlled by an ORP measurement.

Application 3:

From time to time, a „blowdown“ needs to be performed. Highly contaminated cooling water will be replaced by clean water to reduce the concentration of the chemicals, controlled by a conductivity measurement. See attached schematic with indication of measuring parameters and locations.

WHY KNICK ?

Knick offers an extensive modular system for fittings with highly resistant materials against corrosion and suitable sensors for these demanding conditions. Multipurpose use of Stratos Multi, allows different parameters to be monitored with the same equipment.

By using Knick contactless and inductive Memosens technology, many maintenance problems resulting from humidity and corrosion can be avoided. Remote calibration of sensors in laboratory and simply swap sensors at site will help to the operators to run the system smoothly without difficult and time consuming on site calibration.

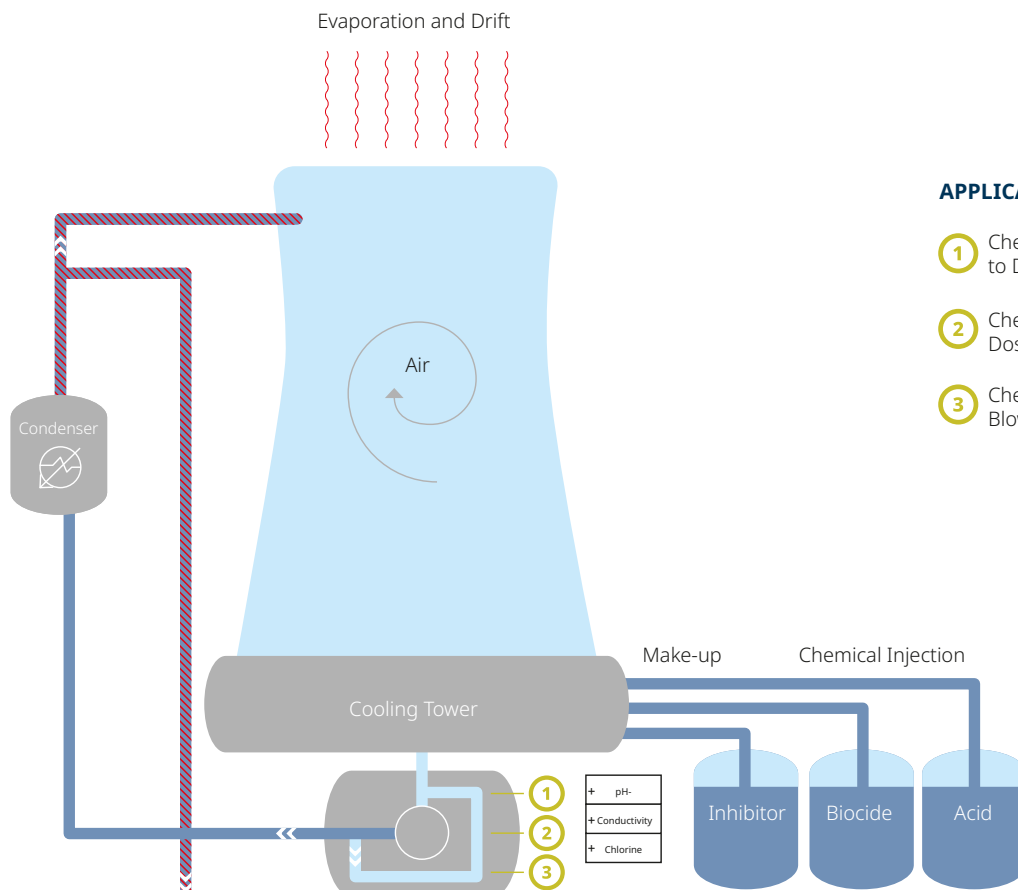

APPLICATIONS

- 1 Check pH after Acid Addition to Dissolve Carbonates
- 2 Check ORP Level after Chlorine Dosing for Desinfection
- 3 Check Conductivity Level to Trigger Blowdown and Condensat

COOLING WATER SYSTEM APPLICATION

1 Check pH after Acid Addition to Dissolve Carbonates

PRODUCT

Stratos Multi



FEATURES

- Dual channel any parameter
- Advanced diagnostics
- Memosens technology
- NAMUR status indications
- Hart, ProfiNet and EtherNet/IP communication options

CUSTOMER BENEFIT

- Small footprint due to double channel, split display
- Sensor diagnostics and alarm indication and transmission

PRODUCT

pH Sensor SE555



FEATURES

- Up to 135 °C, up to 6 bar
- Ceramic junction
- Viscous gel filling
- For aggressive media
- Memosens technology

CUSTOMER BENEFIT

- Long lifetime even in harsh conditions
- Remote calibration
- Sensor/cable connection can be submerged in water (Memosens)

PRODUCT

Manual Retractable Fitting SensoGate



FEATURES

- Manually operated retractable fitting for various sensor types
- 100% sealed against process medium in any position of movement
- Various materials and process connections available

CUSTOMER BENEFIT

- Cleaning, calibration and change of sensor without process interruption
- Highest safety due to special interlocking mechanism

PRODUCT HIGHLIGHT

SENSOGATE

Manual and automatic retractable fittings with pioneering design innovations.

The patented lock-gate principle reliably prevents leakage of process medium during probe movement, since the rinse and calibration chambers are sealed to the process at all times. Gasket cleaning during the movement and the gimbal bearing of the immersion tube significantly extend the service life of the gaskets.



COOLING WATER SYSTEM APPLICATIONS

2 Check ORP Level after Chlorine Dosing for Desinfection

PRODUCT

Stratos Multi



FEATURES

- Dual channel any parameter
- Advanced diagnostics
- Memosens technology
- NAMUR status indications
- Hart, ProfiNet and EtherNet/IP communication options

CUSTOMER BENEFIT

- Small footprint due to double channel, split display
- Sensor diagnostics and alarm indication and transmission

PRODUCT

ORP Sensor SE565



FEATURES

- Sensor element: platinum plate
- Up to 135 °C, up to 6 bar
- Ceramic junction
- Viscous gel filling
- For aggressive media
- Memosens technology

CUSTOMER BENEFIT

- Long lifetime even in harsh conditions
- Remote calibration
- Sensor/cable connection can be submerged in water (Memosens)

PRODUCT

Flow-Through Fitting ARF201



FEATURES

- Robust flow through fitting in polypropylene
- Various sensor and process connections

CUSTOMER BENEFIT

- Suitable for moderate temperatures and high pressures

3 Check Conductivity Level to Trigger Blowdown

PRODUCT

Stratos Multi



FEATURES

- Dual channel any parameter
- Advanced diagnostics
- Memosens technology
- NAMUR status indications
- Hart, ProfiNet and EtherNet/IP communication options

CUSTOMER BENEFIT

- Small footprint due to double channel, split display
- Sensor diagnostics and alarm indication and transmission

PRODUCT

Conductivity Sensor SE630



FEATURES

- High-precision measurement of conductivities up to 50 mS/cm
- 20 to + 135° C, up to 16 bar
- PES body and graphite electrode
- Memosens technology

CUSTOMER BENEFIT

- Accurate measurement
- Suitable for high temperatures and high pressures
- Suitable for corrosive media
- Integrated temperature sensor for compensation
- Robust design and materials

PRODUCT

Flow-Through Fitting ARF201



FEATURES

- Robust flow through fitting in polypropylene
- Various sensor and process connections

CUSTOMER BENEFIT

- Suitable for moderate temperatures and high pressures

PRODUCT HIGHLIGHT

pH SENSORS

With application-specific properties.

pH sensors from Knick have been developed and optimized in close cooperation with users for a wide range of applications. Special glasses, a large variety of junctions (open, PTFE, ceramic, platinum), special reference systems, analog or, of course, digital with Memosens – Knick has the right sensor for every application.

Alpha glass	Medium impedance, universal glass, fluoride resistant
Sigma glass	Low impedance for low-temperature applications
Omega glass	High impedance for high-temperature applications, minimal alkali error, CIP/SIP-capable



CONDUCTIVITY SENSORS

For the complete range of aqueous solutions.

The conductivity of aqueous solutions covers a range of more than eight decades, starting with 0.055 $\mu\text{S}/\text{cm}$ for ultrapure water and going as far as over 1,000 mS/cm for fully dissociated acids or bases. These very different requirements are fulfilled by special Knick sensors. Depending on the application, they come as two- or four-electrode sensors or toroidal sensors.

All sensors are equipped with a temperature detector for automatic temperature compensation.





FLUE GAS DESULFURIZATION

To remove the corrosive SO₂-gas from fossil fuel or waste power plant off gas, a wet scrubber process is used. Limestone, quicklime or calcium hydroxide is used to absorb the SO₂ by forming gypsum which can be reused in building materials. Critical in this process is an accurate pH measurement to ensure complete removal of SO₂ to meet government standards for clean air.

Application 1:

In the pre-scrubber (1st stage) the hot flue gas is cooled by injecting milk of lime. The pH value is only slightly increased (typically between pH 1–2 at 80 °C). Here, the pH must not rise above 2 because only HCl / HF and heavy metals are to be precipitated but SO₂ binding is to occur at the second stage. Accurate pH control is essential.

Application 2:

In the second stage, the main scrubber, the pH is increased by further addition of lime. SO₂ is bound. Here, the lime milk addition must be controlled by continuous pH measurement. When the pH values are too high, too much lime has been added (increased costs) and the gypsum is polluted by excess calcium hydroxide. When the pH values are too low, the binding of SO₂ is less efficient.

The optimum lies between pH 5.5 and 6.0. Higher values lead to soft and greasy calcium sulfite coatings (soft plugging) at slightly reduced efficiency. Lower pH values cause heavy incrustations which are difficult to remove (hard scale formation). Generally, the pH measuring point lies in the back-flow circulation line of the calcium sulfite / gypsum sludge.

Application 3:

The excess water remaining after precipitation / thickening of the gypsum must be subjected to a neutralization procedure. For that purpose, sulfuric acid is added to bind the excess lime. Also, at this measuring point, there are heavy incrustations and deposits.

All 3 measuring points are extremely important to run the process in optimal condition. The locations are corrosive and heavy incrustations are formed resulting in high maintenance. Knick recommends fully automated cleaning and calibration systems for these applications to reduce manual labor and increase process safety.

APPLICATIONS

- 1 Check pH in Pre-Scrubber
- 3 Check pH in Neutralization
- 2 Check pH in Lime Scrubber

WHY KNICK ?

The immense challenge of this application is building up thick layers of gypsum in the gas scrubber units. Ceramat is the only fitting which can be used due to the unique ceramic sealing.

Deposit remover ("Pump Sock") for Ceramat can remove deposits, which would otherwise clog the system completely.

The unique Sensor Maintenance System cleans and calibrates the sensor fully automatically and reduces the maintenance efforts tremendously.

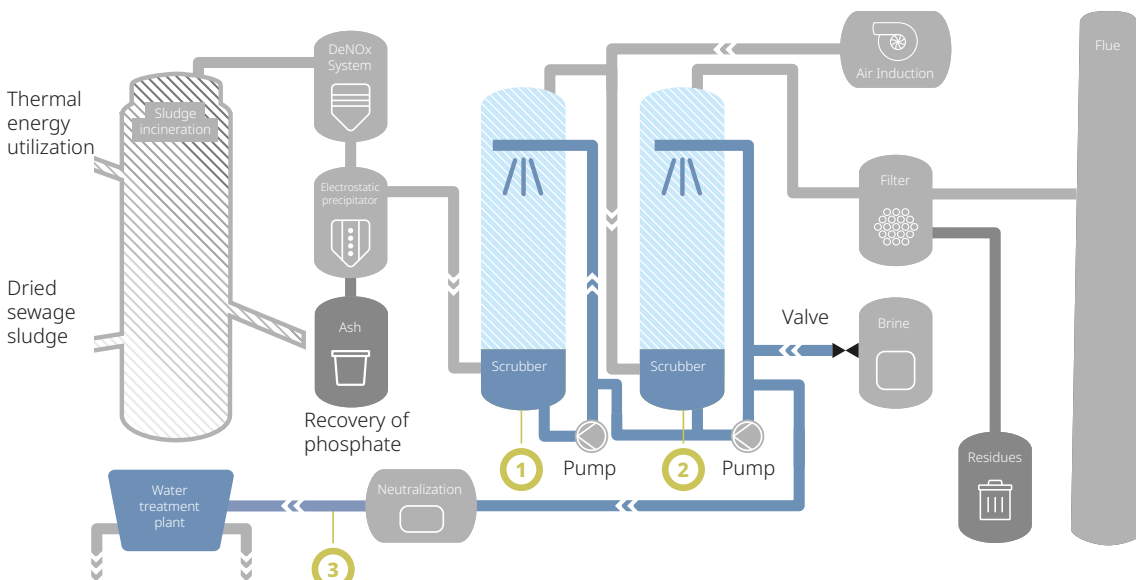

FLUE GAS DESULFURIZATION APPLICATIONS

1 2 3 Check pH in Pre-Scrubber/Lime Scrubber/Neutralization

PRODUCT

Protos



FEATURES

- High resolution graphic display
- Carbon steel or stainless steel housing
- 4 wire, ex zone
- Full diagnostics
- Status messages according to NAMUR

CUSTOMER BENEFIT

- Various input and output connections for integration into process
- Flexible due to various modules for measuring and communication

PRODUCT

pH Sensor SE554



FEATURES

- Up to 130 °C, up to 10 bar
- 2x open hole
- Solid polymer
- For heavy industrial application with a lot of impurities and precipitations
- Memosens technology

CUSTOMER BENEFIT

- Long lifetime even in harsh conditions
- Remote calibration
- Sensor/cable connection can be submerged in water (Memosens)

PRODUCT

Unical/Uniclean



FEATURES

- Automatic cleaning and calibration of pH measuring point
- Timer or remote controlled
- Available in ex zone
- Easy installation and operation

CUSTOMER BENEFIT

- All 5 media (air, water, cleaning and calibration solutions) are connected in one tubing and by one connector plug
- Local switch for maintenance

PRODUCT

Cerammat



FEATURES

- Ceramic parts for long life in corrosive and abrasive suspensions
- No gaskets, lowest maintenance
- Available in ex zone

CUSTOMER BENEFIT

- Lowest maintenance
- Long service life
- Effective cleaning and protection of sensor

PRODUCT HIGHLIGHT

CERAMAT

For tough applications

Patented retractable fitting with ceramic sealing to the process. Harder than steel. Designed as a solution to difficult applications in which conventional fittings with O-ring seals fail.

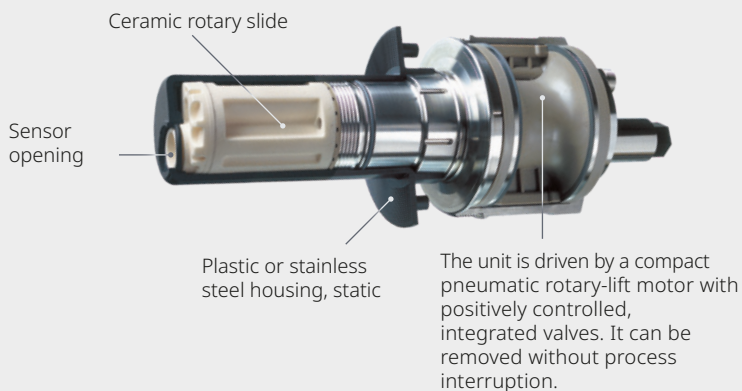



WATER TREATMENT SYSTEMS

Thermal power plants consume high volumes of water and they need to discharge wastewater coming from the following processes:

- Reverse osmosis (RO) concentrate and RO cleaning fluids
- Wastewater from ion exchanger regeneration
- Cooling tower blowdown and boiler cleaning waste water
- Wastewater from flue gas desulfurization and wet scrubbers
- Ash pond overflow, coal storage run off
- Oily wastewater from oil storage (oil fired power plant)

In the following we will describe typical process steps and measuring locations in pretreatment of wastewater and final effluent control before discharge to the environment.

Application 4:

The water in the Ash Pond must be within a pH and ORP range to ensure the plant is meeting the environmental requirement.

WHY KNICK ?

Wastewater usually contains suspended solids – we offer sensors for these demanding conditions and sensor maintenance systems for automatic cleaning.

Furthermore, Memosens technology ensures interference-free measurements even in dirty and humid environments and at long distances.

Application 1:

Wastewater from the power plant is sent to the clarifier to be neutralized with lime. This process creates a significant amount of build-up over time.

Application 2:

After neutralization, the wastewater is treated in an aeration tank by microorganisms. Dissolved oxygen is measured to control the aeration.

Application 3:

The water leaving the treatment plant must be within a pH range of 6.5 to 7.5 to ensure environmental requirements are met.

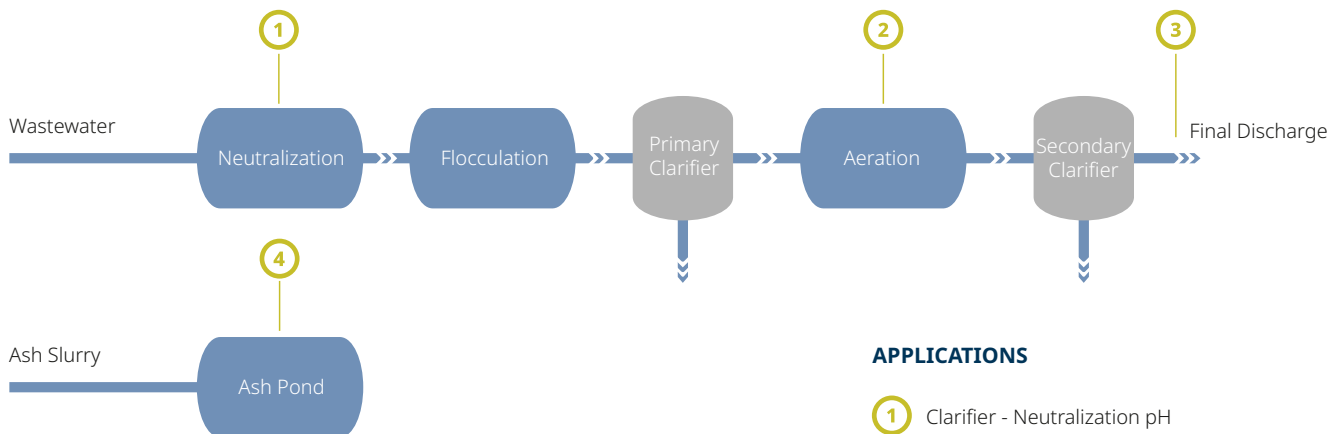

APPLICATIONS

- 1 Clarifier - Neutralization pH
- 2 Aeration DO
- 3 Effluent and Outfall pH
- 4 Ash Pond pH, ORP

WATER TREATMENT APPLICATIONS

1 Clarifier – Neutralization pH

PRODUCT

Stratos Multi



FEATURES

- Dual channel any parameter
- Advanced diagnostics
- Memosens technology
- NAMUR status indications
- Hart, ProfiNet and EtherNet/IP communication options

CUSTOMER BENEFIT

- Small footprint due to double channel, split display
- Sensor diagnostics and alarm indication and transmission

PRODUCT

pH Sensor SE571



FEATURES

- Up to 130 °C, up to 12 bar
- PTFE ring junction
- Ag/AgCl, incl. silver ion trap and salt reservoir
- No contamination or blocking of the junction
- Memosens technology

CUSTOMER BENEFIT

- Long lifetime even in harsh conditions
- Remote calibration
- Sensor/cable connection can be submerged in water (Memosens)
- SE571 annular junction resists fouling.

PRODUCT

Immersion Fitting ARD50



FEATURES

- Robust immersion fitting with high flexibility
- Wall mounting brackets
- Rinse function
- Wetting cup
- Various sensor adapters
- Available in PP-H and PVDF
- High chemical and temperature resistance
- Up to 250 cm immersion depth

CUSTOMER BENEFIT

- Unique design for easy maintenance in combination with Memosens technology

2 Aeration DO

PRODUCT

Stratos Multi



FEATURES

- Dual channel any parameter
- Advanced diagnostics
- Memosens technology
- NAMUR status indications
- Hart, ProfiNet and EtherNet/IP communication options

CUSTOMER BENEFIT

- Small footprint due to double channel, split display
- Sensor diagnostics and alarm indication and transmission

PRODUCT

Optical Oxygen Sensor SE740



FEATURES

- Luminescence technology (optical)
- Range: 4 ppb to 25 ppm – Low maintenance
- Digital communication to meter
- Maintenance by basic cleaning or replacement of cap
- No electrolyte required

CUSTOMER BENEFIT

- High accuracy
- Low maintenance
- Easy to calibrate

PRODUCT

Immersion Fitting ARD50



FEATURES

- Robust immersion fitting with high flexibility
- Wall mounting brackets
- Rinse function
- Wetting cup
- Various sensor adapters
- Available in PP-H and PVDF
- High chemical and temperature resistance
- Up to 250 cm immersion depth

CUSTOMER BENEFIT

- Unique design for easy maintenance in combination with Memosens technology

WATER TREATMENT APPLICATION

3 Effluent and Outfall pH

PRODUCT

Stratos Multi



FEATURES

- Dual channel any parameter
- Advanced diagnostics
- Memosens technology
- NAMUR status indications
- Hart, ProfiNet and EtherNet/IP communication options
- Data Logger to record measurement values

CUSTOMER BENEFIT

- Small footprint due to double channel, split display
- Sensor diagnostics and alarm indication and transmission

PRODUCT

pH Sensor SE555



FEATURES

- Up to 135 °C, up to 6 bar
- Ceramic junction
- Viscous gel filling
- For aggressive media
- Memosens technology

CUSTOMER BENEFIT

- Long lifetime even in harsh conditions
- Remote calibration
- Sensor/cable connection can be submerged in water (Memosens)

PRODUCT

Immersion Fitting ARD50



FEATURES

- Robust immersion fitting with high flexibility
- Wall mounting brackets
- Rinse function
- Wetting cup
- Various sensor adapters
- Available in PP-H and PVDF
- High chemical and temperature resistance
- Up to 250 cm immersion depth

CUSTOMER BENEFIT

- Unique design for easy maintenance in combination with Memosens technology

WATER TREATMENT APPLICATION

4 Ash Pond pH/ORP Monitoring

PRODUCT

Stratos Multi



FEATURES

- Dual channel any parameter
- Advanced diagnostics
- Memosens technology
- NAMUR status indications
- Hart, ProfiNet and EtherNet/IP communication options

CUSTOMER BENEFIT

- Small footprint due to double channel, split display
- Sensor diagnostics and alarm indication and transmission

PRODUCT

ORP Sensor SE564



FEATURES

- Up to 130 °C, up to 10 bar
- 2x open hole
- Solid polymer
- Sensor element: Platinum plate
- For heavy industrial application with a lot of impurities and precipitations
- Memosens technology

CUSTOMER BENEFIT

- Long lifetime even in harsh conditions
- Remote calibration
- Sensor/cable connection can be submerged in water (Memosens)

PRODUCT

pH Sensor SE554



FEATURES

- Up to 130 °C, up to 10 bar
- 2x open hole
- Solid polymer
- For heavy industrial application with a lot of impurities and precipitations
- Memosens technology

CUSTOMER BENEFIT

- Long lifetime even in harsh conditions
- Remote calibration
- Sensor/cable connection can be submerged in water (Memosens)

PRODUCT

Immersion Fitting ARD75



FEATURES

- Robust immersion fitting with high flexibility
- Wall mounting brackets
- Rinse function
- Wetting cup
- Various sensor adapters
- Available in PP-H and PVDF
- High chemical and temperature resistance
- Up to 250 cm immersion depth
- For up to three sensors

CUSTOMER BENEFIT

- Unique design for easy maintenance in combination with Memosens technology

PROCESS ANALYTICS

- > INDUSTRIAL TRANSMITTERS
- > FITTINGS
- > AUTOMATIC CLEANING AND CALIBRATION SYSTEMS
- > SENSORS
- > PORTABLES
- > LABORATORY METERS



**KNICK
ELEKTRONISCHE MESSGERÄTE
GMBH & CO. KG**

Beuckestraße 22, 14163 Berlin
Telefon: +49 30 80191-0
Telefax: +49 30 80191-200
info@knick.de · www.knick-international.com