

# Stratos Pro A201COND

Conductivity Measurement  
with 2-/4-Electrode Sensors

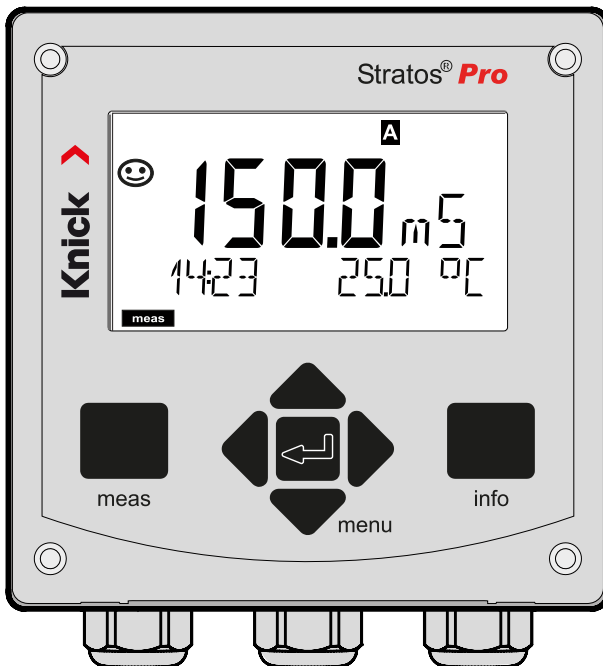

Read before installation.  
Keep for future use.



# Supplemental Directives

---

Read this document and retain it for future reference. Before assembling, installing, operating, or maintaining the product, ensure that you fully understand the instructions and risks. Observe all safety instructions. Failure to follow the instructions in this document may result in serious injury and/or property damage.

This document is subject to change without notice.

These supplemental directives explain how safety information is laid out in this document and what content it covers.

## Safety Chapter



This document's Safety chapter is designed to give the reader a basic understanding of safety. It illustrates general hazards and gives strategies on how to avoid them.

## Safety Guide

The external Safety Guide is designed to give the reader a basic understanding of safety. It illustrates general hazards and suggests strategies on how to avoid them.

## Warnings

This document uses the following warnings to indicate hazardous situations:

Symbol	Category	Meaning	Remark
	WARNING	Designates a situation that can lead to death or serious (irreversible) injury.	The warnings contain information on how to avoid the hazard.
	CAUTION	Designates a situation that can lead to slight or moderate (reversible) injury.	
None	NOTICE	Designates a situation that can lead to property or environmental damage.	

## Additional Safety Information

Stratos Safety Guide

## **Safety Guide**

In official EU languages and others

## **Quickstart Guides**

Installation and first steps:

- Operation
- Menu structure
- Calibration
- Error messages and recommended actions

## **Test Report 2.2 According to EN 10204**

## **Electronic Documentation**

[www.knick-international.com](http://www.knick-international.com):

Manuals + software

Ex devices:

## **Control Drawings**

## **EU Declaration of Conformity**

# Table of Contents

---

<b>Supplemental Directives</b> .....	<b>2</b>
<b>Documents Supplied</b> .....	<b>3</b>
<b>Safety</b> .....	<b>7</b>
Intended Use.....	7
Personnel Requirements.....	8
Residual Risks.....	8
Installation and Commissioning .....	9
Operation in Hazardous Locations .....	10
<b>Introduction</b> .....	<b>11</b>
<b>Overview of Stratos Pro A201COND</b> .....	<b>14</b>
<b>Assembly</b> .....	<b>15</b>
Package Contents.....	15
Mounting Plan, Dimensions .....	16
Pipe Mounting, Protective Hood .....	17
Panel Mounting.....	18
<b>Electrical Installation</b> .....	<b>19</b>
Cable Glands .....	19
Rating Plates / Terminal Assignments.....	20
Wiring of Stratos Pro A201COND .....	21
Wiring Examples .....	22
Connecting a Memosens Sensor.....	30
<b>User Interface, Keypad</b> .....	<b>31</b>
<b>Display</b> .....	<b>32</b>
Signal Colors (Display Backlighting).....	32
Measuring Mode.....	33
Selecting the Mode / Entering Values .....	34
<b>Display in Measuring Mode</b> .....	<b>35</b>
<b>Color-Coded User Interface</b> .....	<b>36</b>

<b>Operating Modes</b> .....	<b>37</b>
Menu Structure of Modes and Functions.....	38
HOLD Mode.....	39
Alarm.....	40
Alarm and HOLD Messages.....	41
<b>Configuration</b> .....	<b>42</b>
Menu Structure of Configuration.....	42
Parameter Set Selection.....	44
Configuration (Template for Copy).....	50
Sensor.....	52
Sensor Verification (TAG, GROUP).....	60
Current Output 1.....	62
Current Output 2.....	72
Temperature Compensation.....	74
CONTROL Input (TAN SW-A005).....	78
Alarm Settings.....	80
Time and Date.....	84
Measuring Points (TAG/GROUP).....	86
Display Backlighting.....	86
<b>Digital Sensors</b> .....	<b>88</b>
Operation.....	88
Connecting a Digital Sensor.....	89
Replacing a Sensor.....	90
<b>Calibration</b> .....	<b>93</b>
Selecting a Calibration Mode.....	93
Calibration with Calibration Solution.....	94
Calibration by Entry of Cell Constant.....	96
Calibration by Entry of Installation Factor.....	97
Product Calibration.....	98
Temp Probe Adjustment.....	100
<b>Measurement</b> .....	<b>101</b>
<b>Diagnostics</b> .....	<b>102</b>

# Table of Contents

---

<b>Service .....</b>	<b>107</b>
<b>USP Function .....</b>	<b>110</b>
<b>Operating States.....</b>	<b>111</b>
<b>Maintenance and Repair .....</b>	<b>112</b>
<b>A201B/X: Supply Units and Connection .....</b>	<b>113</b>
<b>Product Line and Accessories .....</b>	<b>114</b>
<b>Specifications .....</b>	<b>115</b>
<b>Calibration Solutions .....</b>	<b>121</b>
<b>Concentration Measurement .....</b>	<b>123</b>
Concentration Curves .....	124
<b>Error Handling.....</b>	<b>129</b>
<b>Error Messages.....</b>	<b>130</b>
<b>Decommissioning.....</b>	<b>133</b>
Disposal.....	133
Returns .....	133
<b>Sensoface .....</b>	<b>134</b>
Sensocheck.....	134
<b>HART: Typical Applications .....</b>	<b>136</b>
<b>FDA 21 CFR Part 11 .....</b>	<b>137</b>
Electronic Signature – Passcodes .....	137
Audit Trail .....	137

This document contains important instructions for the use of the product. Always follow these instructions and take care when operating the product. If you have any questions, please contact Knick Elektronische Messgeräte GmbH & Co. KG ("Knick") using the contact details provided on the back page of this document.

## **Intended Use**

Stratos Pro A201COND (the "device" or "product") is a 2-wire device for measuring electrical conductivity and temperature in liquids. It is used in biotechnology, the chemical industry, environmental and food sectors, and water/wastewater technology.

Stratos Pro A201X and the separately approved Ex sensor may be operated in Zone 0/Division 1.

Stratos Pro A201B and the separately approved Ex sensor may be operated in Zone 2.

The defined rated operating conditions must be observed when using this product. They can be found in the Specifications chapter of this User Manual; see page 115.

Replacement of the measuring module is not intended for devices in the Stratos Pro series.

## **Devices Not Intended for Use in Hazardous Locations**

Devices identified with an N in their product name must not be used in hazardous locations.

## **Personnel Requirements**

The operating company must ensure that employees who use or otherwise handle the product are sufficiently trained and have been properly instructed.

The operating company must comply with all applicable laws, regulations, ordinances, and relevant industry qualification standards pertaining to the product and ensure that its employees do so as well. Failure to comply with the aforementioned provisions constitutes a breach of duty by the operating company with respect to the product. Such improper use of the product is not permitted

## **Residual Risks**

The product has been developed and manufactured in accordance with generally accepted safety rules and regulations. Under certain circumstances, however, usage may pose risks to users or cause damage to the device.

The following residual risks exist:

- Ambient conditions with chemically corrosive substances may prevent the system from working properly.
- The configuration menu is not protected against misuse by an appropriate passcode.

Conditions for the safe use of the device include adherence to the specified environmental and temperature ranges. If the information in the User Manual does not clearly indicate safe use, such as in applications other than those described, the permissibility of use must be coordinated with the manufacturer.



## **Installation and Commissioning**

Adhere to all applicable local and national codes and standards for the installation of electrical equipment.

Comply with the points below during installation and commissioning:

- The device must be permanently installed by a trained electrician in accordance with the regulations and standards applicable at the installation site.
- Take care to avoid notches when stripping the wires.
- The device must be commissioned and fully configured and adjusted by authorized professional personnel.

If safe operation is not possible, the device must not be switched on or, if it is already on, must be switched off properly and secured against unintended operation.

Reasons to assume safe operation is not possible:

- the device shows visible damage
- failure to perform the intended function

The device may only be recommissioned following a professional routine test conducted by the manufacturer.

## **Function Check Mode (HOLD Function)**

After activating configuration, calibration, or service, Stratos Pro enters function check mode (HOLD).

The current outputs respond in accordance with the configuration.

Operations must not be carried out while the Stratos is in function check mode (HOLD), as the system may behave unexpectedly and put users at risk.

## Operation in Hazardous Locations

The following notes apply to devices marked with B or X.

Related certificates are included with the product and are available in their current version at [www.knick-international.com](http://www.knick-international.com).

Observe all applicable local and national codes and standards for the installation of electrical equipment in hazardous locations. For further guidance, consult the following:

- IEC 60079-14
- EU directives 2014/34/EU and 1999/92/EC (ATEX)
- NFPA 70 (NEC)
- ANSI/ISA-RP12.06.01

Comply with the points below:

- In a hazardous location, only cable glands with suitable approvals may be used. The installation instructions of the manufacturer must be observed.
- In hazardous locations, the device may only be cleaned with a damp cloth to prevent electrostatic charging.
- Devices and modules that have already been used must be subjected to a professional routine test before they may be operated in another zone or another type of protection.
- Before the product is commissioned, the operating company must provide proof that the product is permitted to be connected to other equipment (including cables and wires). Connecting components designed for explosive atmospheres and those not designed for explosive atmospheres (mixed equipping) is not permitted.

## Housing and Mounting Options

- The sturdy molded enclosure is designed for IP66/IP67 / TYPE 4X Outdoor protection, is made of PBT glass fiber reinforced PC, and has the following dimensions: H 148 mm, W 148 mm, T 117 mm. Knockouts in the housing enable
- wall mounting (with sealing plugs to seal the housing)  
see page 16
- pipe mounting (Ø 40 ... 60 mm, □ 30 ... 45 mm)  
see page 17
- panel mounting (cutout 138 mm x 138 mm acc. to DIN 43700)  
see page 18

## Protective Hood (Accessory)

The protective hood, which is available as accessory, provides additional protection against direct weather exposure and mechanical damage; see page 17.

## Connection of Sensors, Cable Glands

For connecting the cables, the enclosure provides

- 3 knockouts for M20x1.5 cable glands
- 2 knockouts for ½" conduit

For quasi-stationary installations with Memosens sensors, we recommend using the M12 socket accessory (ZU0822) instead of a cable gland – which allows simple replacement of the sensor cable without opening the device.

## Sensors

The device has been designed for 2- and 4-electrode sensors, particularly for Model SE600, SE603, SE604, SE610, SE620, SE630 sensors. (It can easily be retrofitted for Memosens sensors.)

# Introduction

---

## **Display**

Plain-text messages on a large, backlit LC display enable intuitive operation. You can specify which values are to be displayed in standard measuring mode ("Main Display," see page 35).

## **Color-Coded User Interface**

The colored display backlighting indicates different operating states (e.g., alarm: red, HOLD mode: orange; see page 36). The display backlighting can be switched off; see page 86.

## **Diagnostic Functions**

"Sensocheck" automatically monitors sensor and cables; and the "Sensoface" function clearly indicates the sensor condition; see page 134.

## **Data Logger**

The internal logbook (TAN SW-A002) can handle up to 100 entries – up to 200 with AuditTrail (TAN SW-A003); see page 105.

## **Two Parameter Sets A, B**

The device provides two parameter sets that can be switched manually or via a control input for different process connections or different process conditions.

For an overview of parameter sets (original for copy), see page 50.

## **Password Protection**

Password protection (passcodes) for granting access rights during operation can be configured; see page 109.

## **TC process medium: Selecting the compensation method**

The following temperature compensation methods are provided: linear (by entering a temperature coefficient), natural waters (nLF), ultrapure water with traces of NaCl, HCl, NH<sub>3</sub>, NaOH, see page 74.

## Control Inputs (TAN SW-A005)

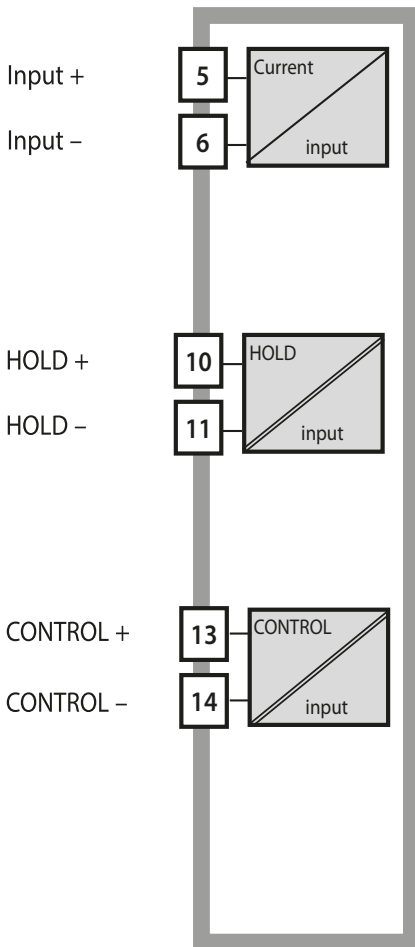

### I input

The analog (0) 4 ... 20 mA current input can be used for external temperature compensation; see page 74.

### HOLD

(Floating digital control input)  
The HOLD input can be used for external activation of HOLD mode; see page 39.

### CONTROL

(Floating digital control input)  
The CONTROL input can be used either for parameter set selection (A/B) or for flow monitoring; see page 78.

## Signal Outputs

The device provides two current outputs (for transmission of measured value and temperature, for example). The output curve is adjustable (linear, bilinear or logarithmic), see page 64.

## Options

Additional functions can be enabled by entering a TAN (p. 109).

# Overview

## Overview of Stratos Pro A201COND

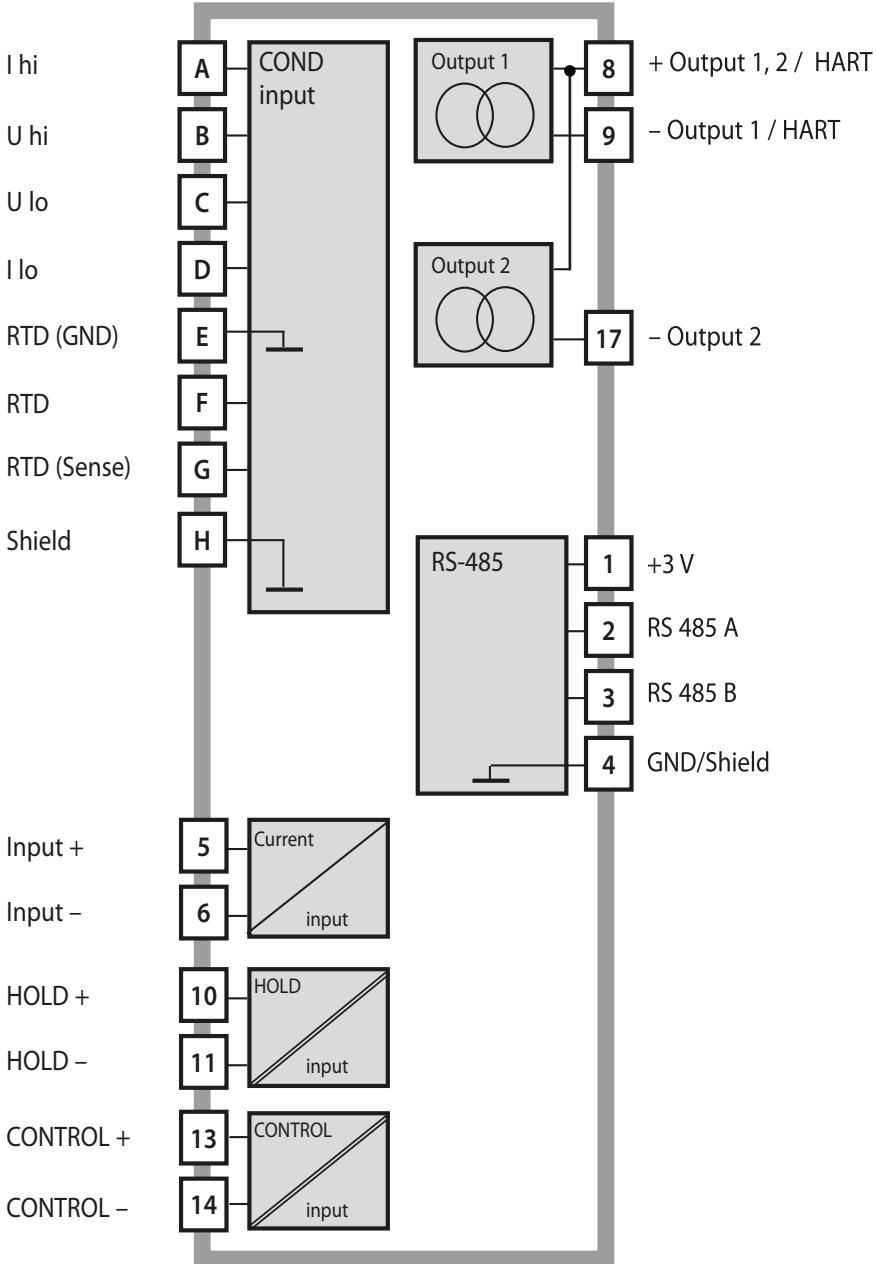

## Package Contents

**Note:** Check all components for damage upon receipt.  
Do not use damaged parts.

**The package should contain:**

- Front unit, rear unit, bag containing small parts
- Specific test report
- Documentation (see page 3)

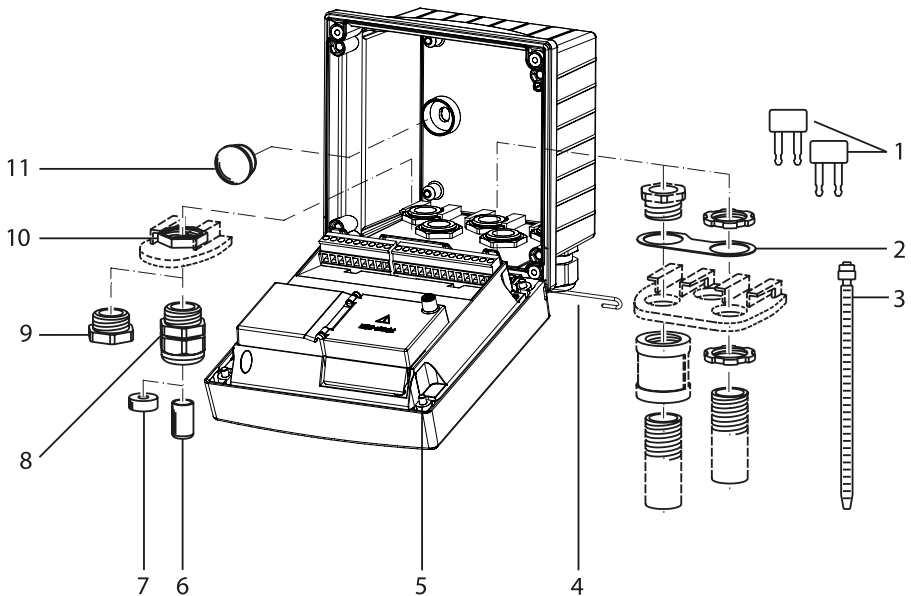

Fig.: Assembling the enclosure

- |                                                                    |                                                                     |
|--------------------------------------------------------------------|---------------------------------------------------------------------|
| 1) Insertable jumper (3x)                                          | 6) Blanking plug (2x, non-Ex only)                                  |
| 2) Plate (1x), for conduit mounting: Plate between housing and nut | 7) Reduction sealing insert (1x)                                    |
| 3) Cable tie (3x)                                                  | 8) Cable gland (3x)                                                 |
| 4) Hinge pin (1x), insertable from either side                     | 9) Blanking cap (2x)                                                |
| 5) Enclosure screw (4x)                                            | 10) Hex nut (5x)                                                    |
|                                                                    | 11) Plastic sealing plug (2x), for sealing in case of wall mounting |

## Mounting Plan, Dimensions

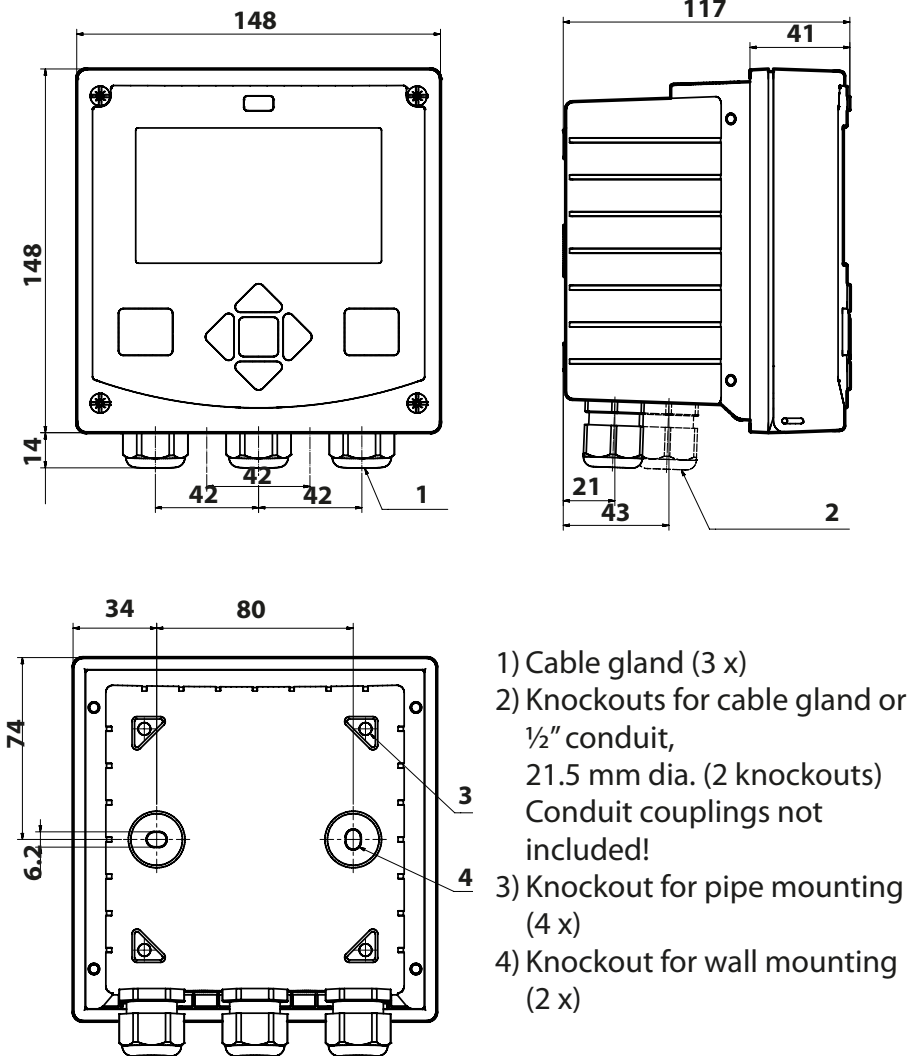
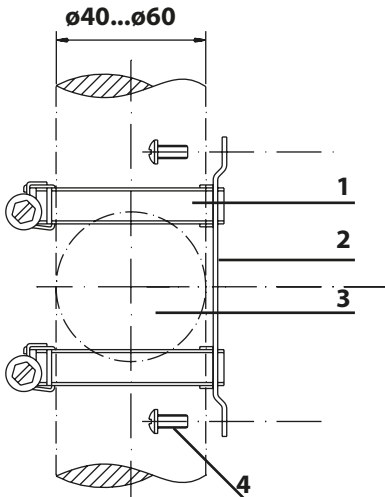

Fig.: Mounting plan (All dimensions in mm!)



## Pipe Mounting, Protective Hood



- 1) Hose clamp with worm gear drive to DIN 3017 (2 x)
- 2) Pipe-mount plate (1 x)
- 3) For vertical or horizontal posts or pipes
- 4) Self-tapping screw (4 x)

Fig.: Pipe-mount kit, accessory ZU 0274 (All dimensions in mm!)

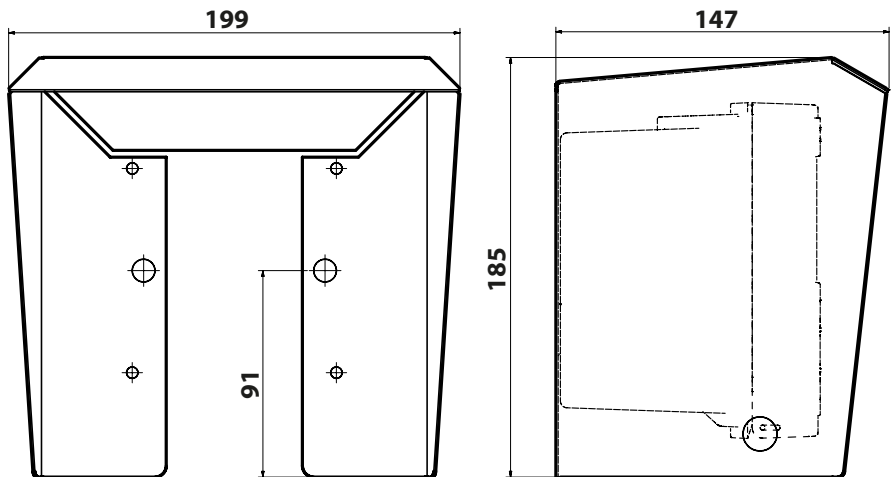
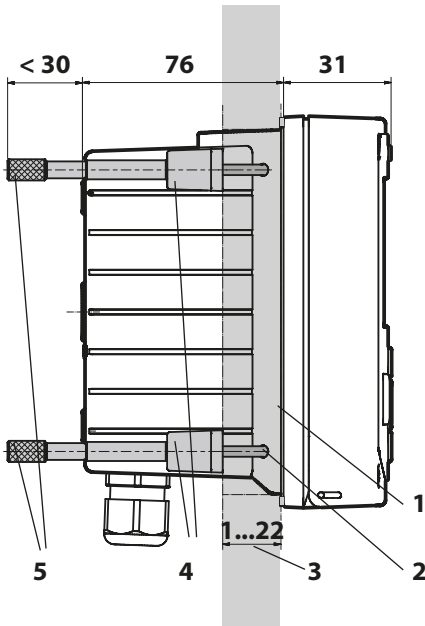

Fig.: Protective hood for wall and pipe mounting, accessory ZU 0737 (All dimensions in mm!)

## Panel Mounting



- 1) Circumferential sealing (1 x)
- 2) Screws (4 x)
- 3) Position of control panel
- 4) Span piece (4 x)
- 5) Threaded sleeve (4 x)

Cutout  
138 x 138 mm (DIN 43700)

Fig.: Panel-mount kit, accessory ZU 0738 (All dimensions in mm!)

# Electrical Installation

---

Before commencing with the installation, make sure that all lines to be connected are de-energized.

Observe the safety instructions; see page 7.

## Cable Glands

In a hazardous location, only cable glands with suitable approvals may be used. The installation instructions of the manufacturer must be observed.

---

Cable glands	5 cable glands M20 x 1.5 A/F 24 mm WISKA type ESKE/1 M20
Clamping ranges	Standard sealing insert: 7 ... 13 mm
	Reduction sealing insert: 4 ... 8 mm
	Multiple sealing insert: 5.85 ... 6.5 mm
Tensile strain	Not permitted; Only suitable for "fixed installation"

---

**⚠ CAUTION!** Risk of losing the specified ingress protection. Fasten the cable glands and screw together the housing correctly. Observe the permissible cable diameters and tightening torques. Only use original accessories and spare parts.

**NOTICE!** Strip the insulation from the wires using a suitable tool to prevent damage. For stripping length, see Specifications.

- 1) Wire the current outputs. Deactivate unused current outputs in the parameter settings or use jumpers.
- 2) Wire the inputs as necessary.
- 3) Connect the sensor.
- 4) Check whether all connections are correctly wired.
- 5) Close the housing and successively tighten the enclosure screws in a diagonal pattern.

## Rating Plates / Terminal Assignments

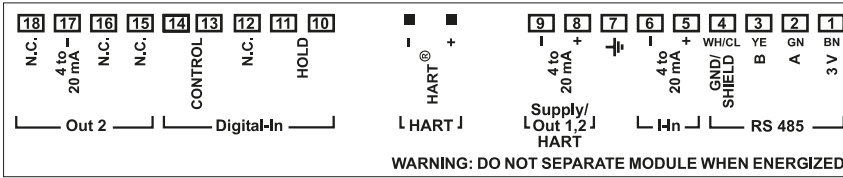

Fig.: Terminal assignments of Stratos Pro A201

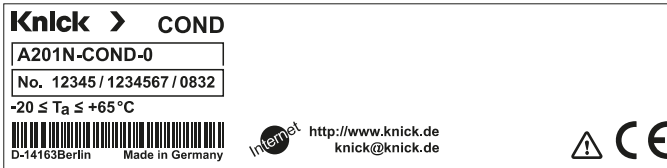
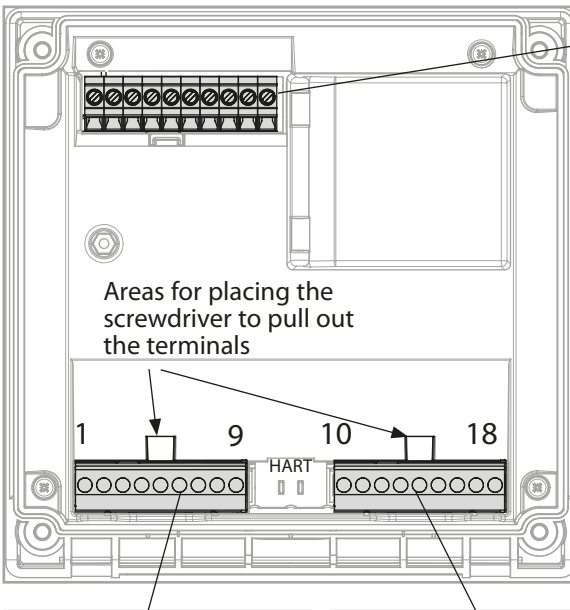

Fig.: Stratos Pro A201N rating plate at outside bottom of front (illustrative example)

## Wiring of Stratos Pro A201COND



### Sensor connection MK-COND module

A	I hi
B	U hi
C	U lo
D	I lo
E	RTD (GND)
F	RTD
G	RTD (Sense)
H	Shield

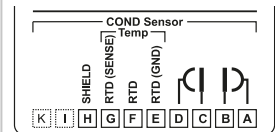

Fig.: MK-COND module terminal assignments

#### Note:

When a Memosens sensor is to be connected to the RS-485 interface (terminals 1...4), you must remove the MK-COND module.

### Terminal row 1

1	+3 V
2	RS 485 A
3	RS 485 B
4	GND/shield
5	+ input
6	- input
7	PA
8	+ out 1,2/HART
9	- out1/HART

### Terminal row 2

10	hold
11	hold
12	n.c.
13	contr.
14	contr.
15	n.c.
16	n.c.
17	- out 2
18	n.c.

In addition:

2 HART pins (between terminal row 1 and 2)

Fig.: Terminals, device opened, back of front unit

# Wiring Examples

## Example 1:

Measuring task: Conductivity, temperature

Sensors (principle): 4 electrodes

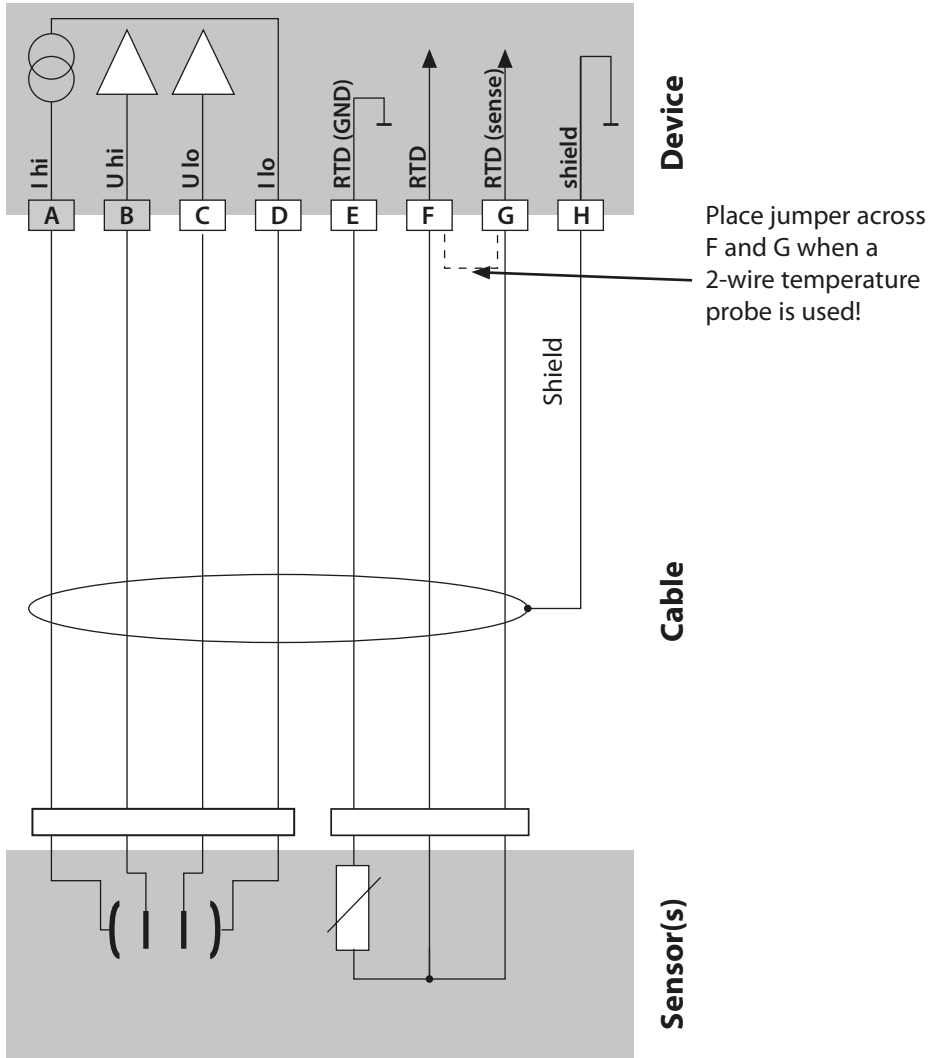

## Example 2:

Measuring task: Conductivity, temperature  
 Sensors (principle): 2 electrodes, coaxial

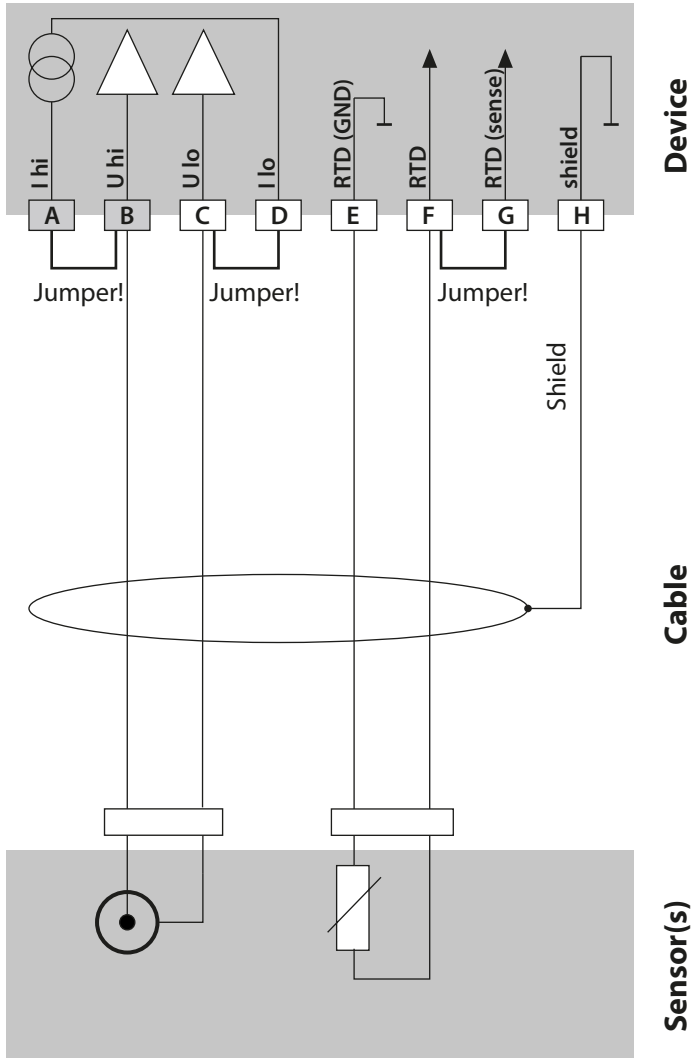

# Wiring Examples

## Example 3:

Measuring task: Conductivity, temperature

Sensors (example): SE604

Cable: ZU0645

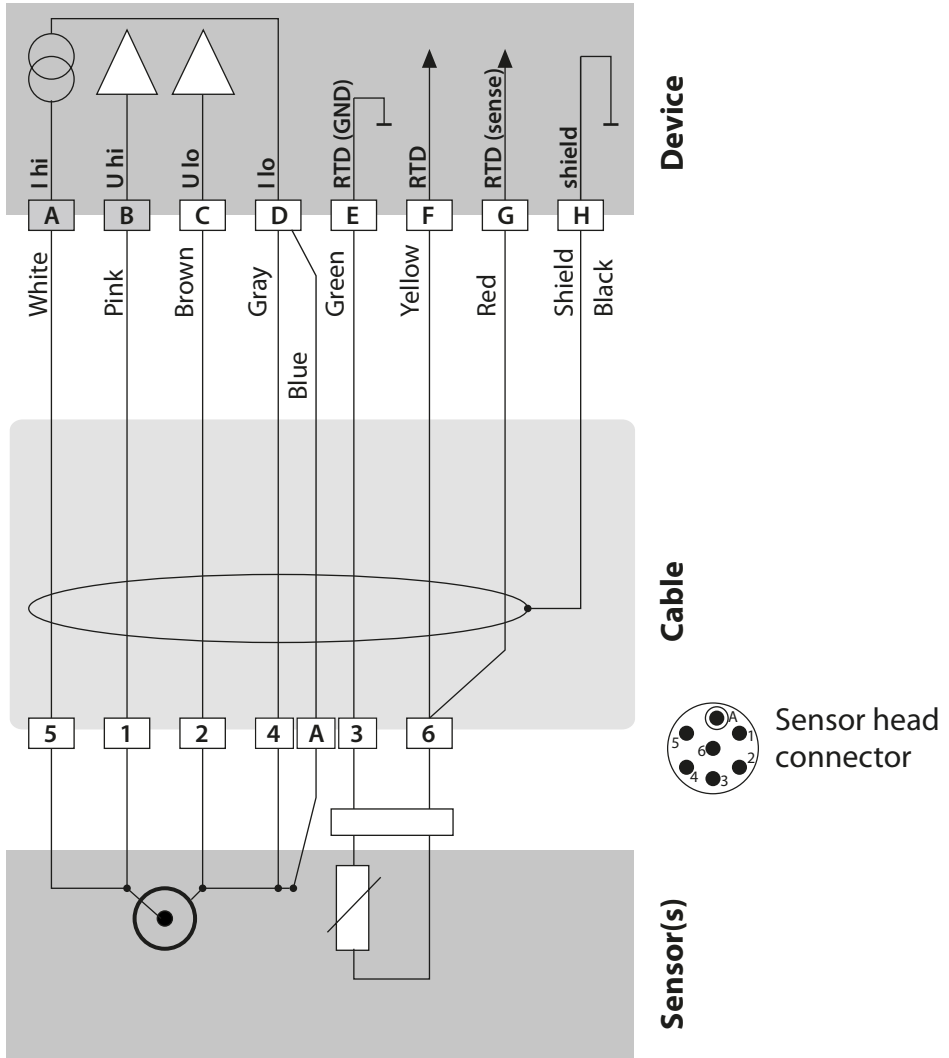



## Example 4:

Measuring task: Conductivity, temperature

Sensors (example): SE610

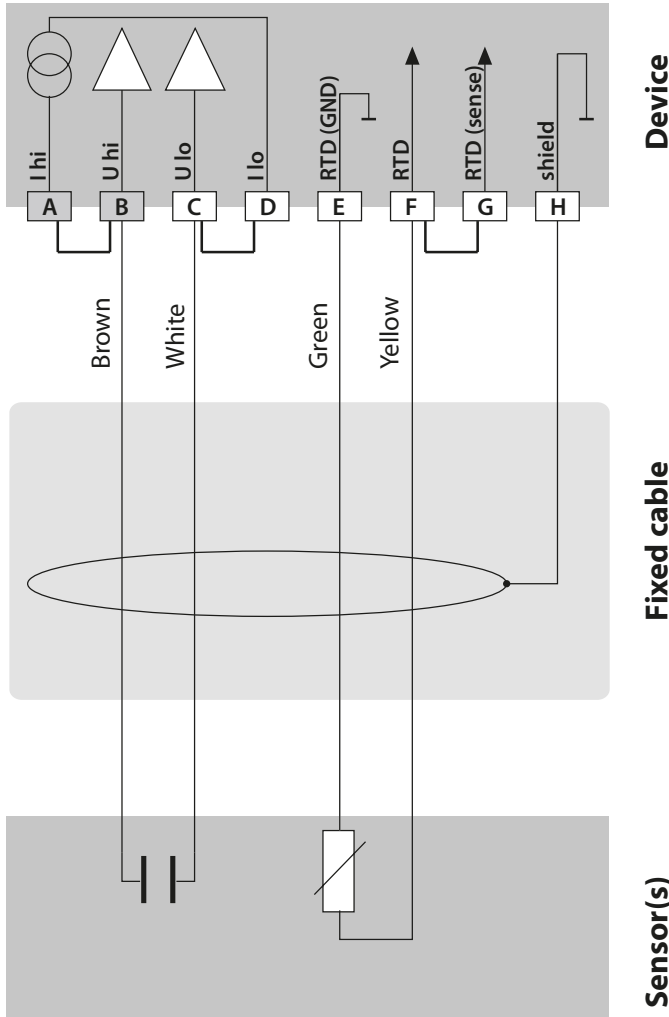

# Wiring Examples

## Example 5:

Measuring task: Conductivity, temperature

Sensors (example): SE620

VP cable: e.g, CA/VP6ST-003A

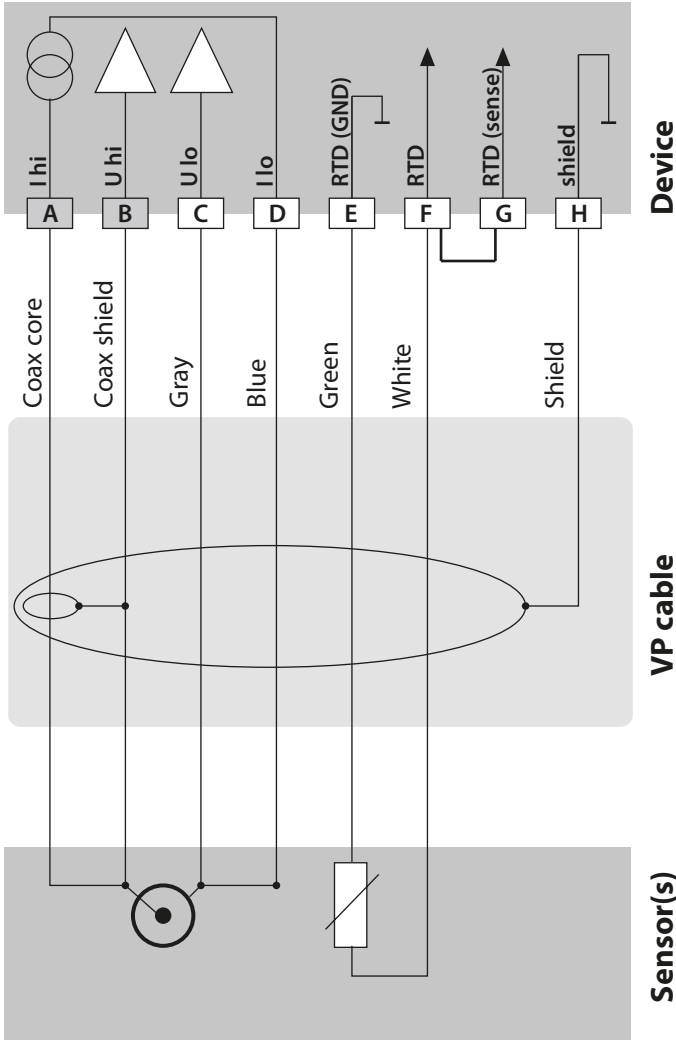

## Example 6:

Measuring task: Conductivity, temperature

Sensors (example): SE630

Connection via GDM connector

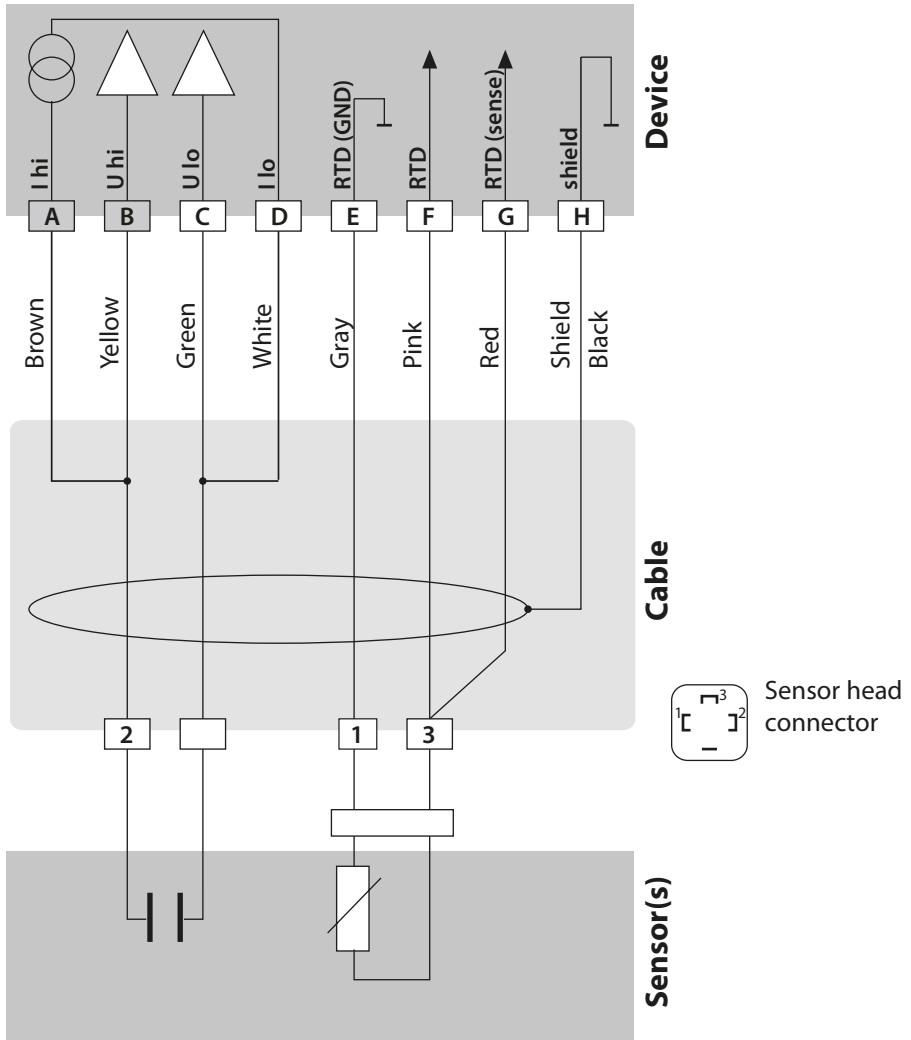

# Wiring Examples

## Example 7:

Measuring task: Conductivity, temperature

Sensors (example): SE600 / SE603 4-electrode fringe-field sensor

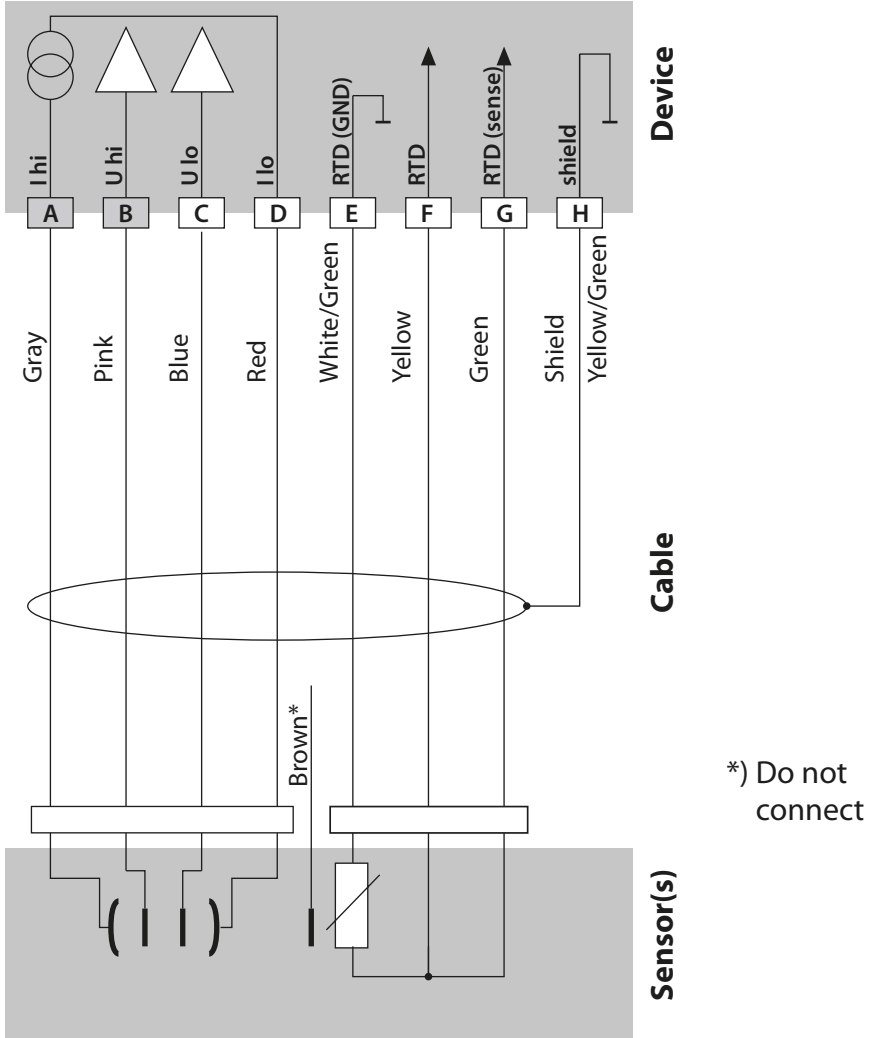

## Example 8:

Measuring task: Conductivity, temperature

Sensor: Memosens

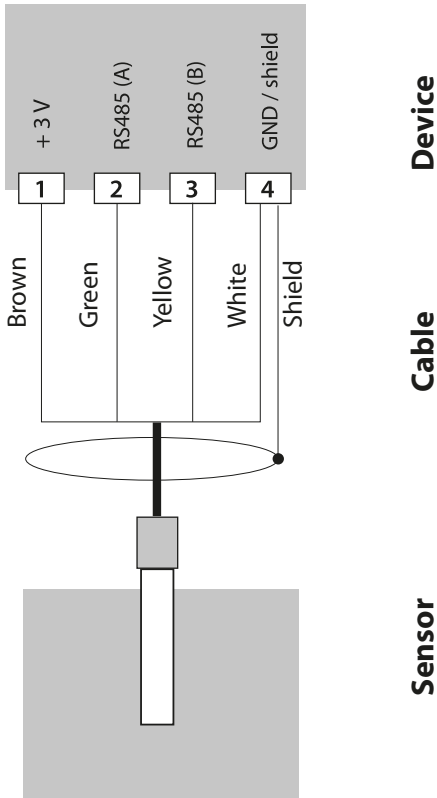

The Memosens sensor is connected to the RS-485 interface of the device – for an A2... Series (2-wire) device, the measuring module slot must be empty. Therefore, first remove the measuring module from the slot (see next page). Open the CONFIG menu and select "MEMOSENS". The connected Memosens sensor is then automatically recognized during start-up of the transmitter.

# Connecting a Memosens Sensor

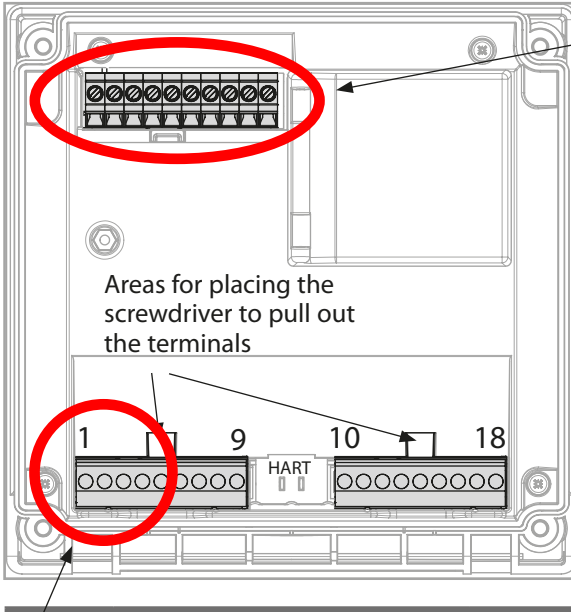

**NOTICE!**

The slot for the MK-COND module must be empty – be sure to remove the module!

**Connection of Memosens: Wire color**

1	+3 V	Brown
2	RS 485 A	Green
3	RS 485 B	Yellow
4	GND/shield	White, transparent shield

# User Interface, Keypad

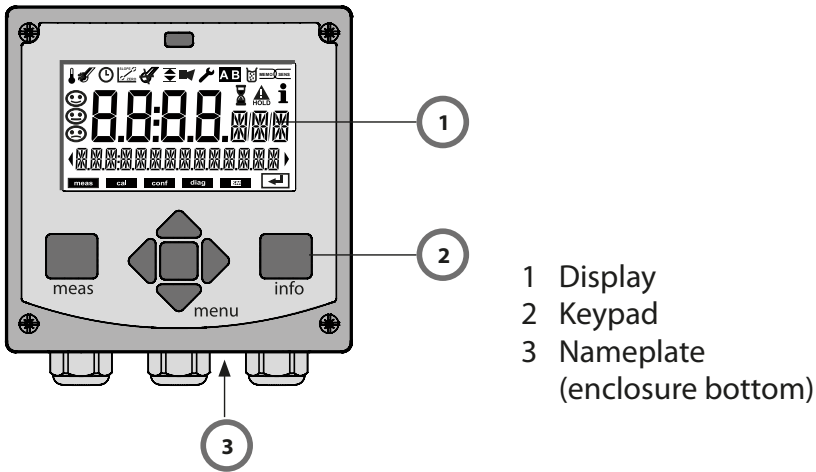

Key	Function
<b>meas</b>	<ul style="list-style-type: none"><li>• Return to last menu level</li><li>• Directly to measuring mode (press &gt; 2 s)</li><li>• Measuring mode: other display</li></ul>
<b>info</b>	<ul style="list-style-type: none"><li>• Retrieve information</li><li>• Show error messages</li></ul>
<b>enter</b>	<ul style="list-style-type: none"><li>• Configuration: Confirm entries, next configuration step</li><li>• Calibration: Continue program flow</li></ul>
<b>menu</b>	<ul style="list-style-type: none"><li>• Measuring mode: Call menu</li></ul>
<b>Arrow keys up / down</b>	<ul style="list-style-type: none"><li>• Menu: Increase/decrease a numeral</li><li>• Menu: Selection</li></ul>
<b>Arrow keys left / right</b>	<ul style="list-style-type: none"><li>• Previous/next menu group</li><li>• Number entry: Move between digits</li></ul>

# Display

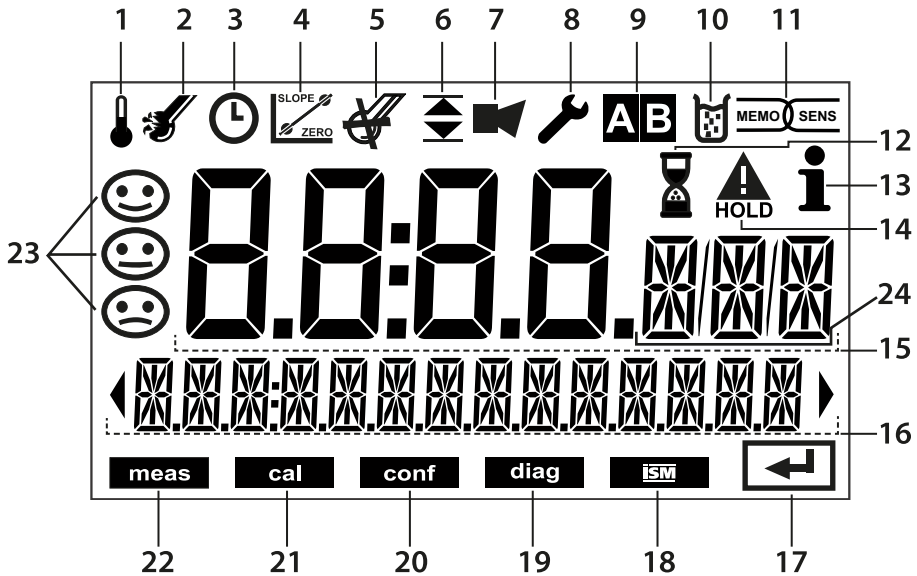

- |    |                                          |    |                     |
|----|------------------------------------------|----|---------------------|
| 1  | Temperature                              | 13 | Info available      |
| 2  | Sensocheck                               | 14 | Hold mode active    |
| 3  | Interval/response time                   | 15 | Main display        |
| 4  | Sensor data                              | 16 | Secondary display   |
| 5  | Not used                                 | 17 | Proceed using enter |
| 6  | Limit message:<br>Limit 1 ▼ or Limit 2 ▲ | 18 | Not used            |
| 7  | Alarm                                    | 19 | Diagnostics         |
| 8  | Service                                  | 20 | Configuration mode  |
| 9  | Parameter set                            | 21 | Calibration mode    |
| 10 | Calibration                              | 22 | Measuring mode      |
| 11 | Memosens                                 | 23 | Sensoface           |
| 12 | Waiting time running                     | 24 | Unit symbols        |

## Signal Colors (Display Backlighting)

- |              |                                                 |
|--------------|-------------------------------------------------|
| Red          | Alarm (in case of fault: display values blink)  |
| Red blinking | Input error: illegal value or wrong passcode    |
| Orange       | HOLD mode (Calibration, Configuration, Service) |
| Turquoise    | Diagnostics                                     |
| Green        | Info                                            |
| Magenta      | Sensoface message                               |



# Measuring Mode

After the operating voltage has been connected, the analyzer automatically goes to "Measuring" mode. To call the measuring mode from another operating mode (e.g., Diagnostics, Service): Hold **meas** key depressed (> 2 s).

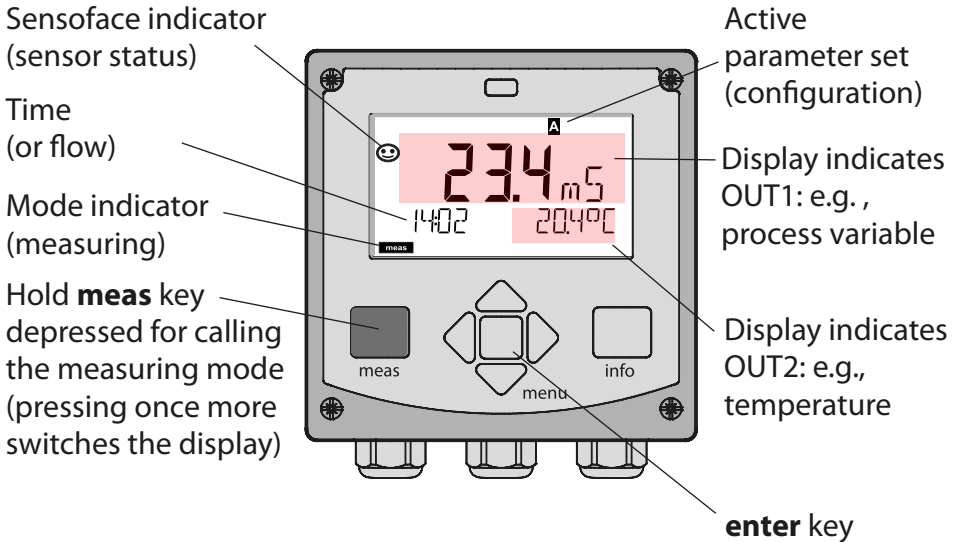

Depending on the configuration, one of the following displays can be set as standard display for the measuring mode (see page 35):

- Measured value, time and temperature (default setting)
- Measured value and selection of parameter set A/B or flow
- Measured value and tag number ("TAG")
- Time and date

**Note:** By pressing the **meas** key in measuring mode you can view the displays for approx. 60 sec.



The device must be configured for the respective measurement task, see page 42.

# Selecting the Mode / Entering Values

## To select the operating mode:

- 1) Hold **meas** key depressed (> 2 s) (directly to measuring mode)
- 2) Press **menu** key: the selection menu appears
- 3) Select operating mode using left / right arrow key
- 4) Press **enter** to confirm the selected mode

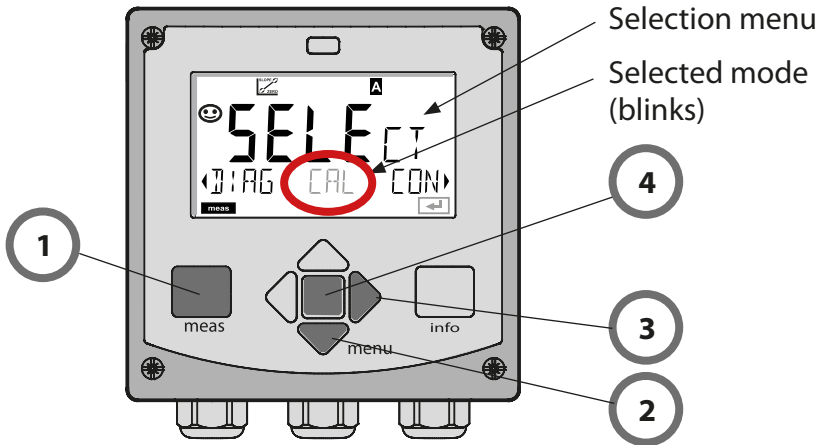

## To enter a value:

- 5) Select numeral: left / right arrow key
- 6) Change numeral: up / down arrow key
- 7) Confirm entry by pressing **enter**

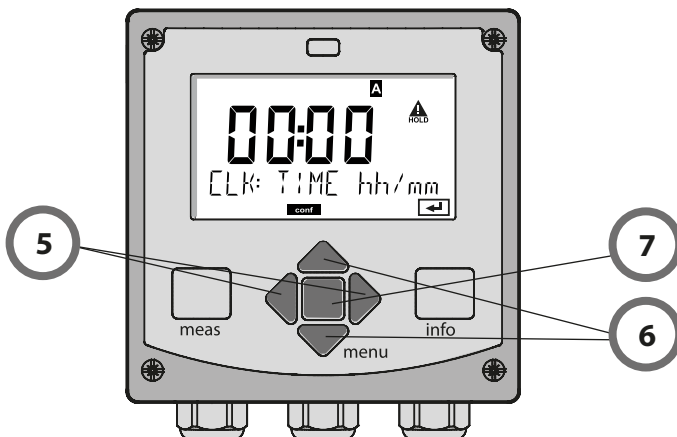

# Display in Measuring Mode

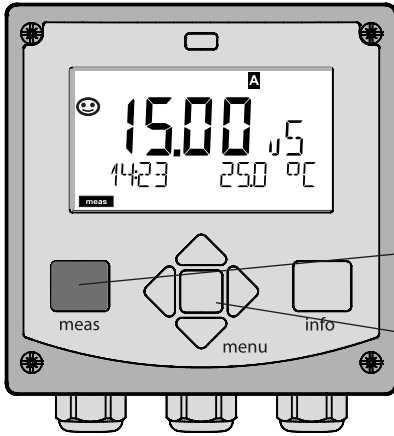

The MAIN DISPLAY is the display which is shown in measuring mode. To call the measuring mode from any other mode, hold the **meas** key depressed for at least 2 sec.

**meas** key

**enter** key



By pressing **meas** briefly you can step through further displays such as tag number (TAG) or flow (L/h). These displays are turquoise. After 60 sec they switch back to the main display.

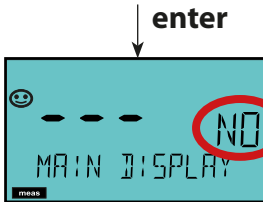
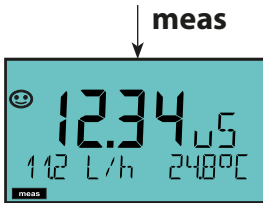

Press **enter** to select a display as MAIN DISPLAY – the secondary display shows “MAIN DISPLAY – NO”. Use the **UP / DOWN** arrow keys to select “MAIN DISPLAY – YES” and confirm by pressing **enter**. The display color changes to white. This display is now shown in measuring mode.



# Color-Coded User Interface

The color-coded user interface\* guarantees increased operating safety. Operating modes are clearly signaled.

The normal measuring mode is white. Information text appears on a green screen and the diagnostic menu appears on turquoise.

The orange HOLD mode (e.g. during calibration) is quickly visible as is the magenta screen which indicates asset management messages for predictive diagnostics – such as maintenance request, pre-alarm and sensor wear.

The alarm status has a particularly noticeable red display color and is also signaled by flashing display values. Invalid inputs or false pass-codes cause the entire display to blink red so that operating errors are noticeably reduced.

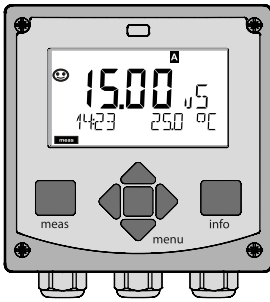

White:  
Measuring mode

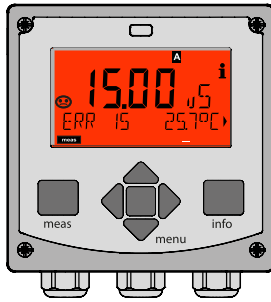

Red blinking:  
Alarm, errors

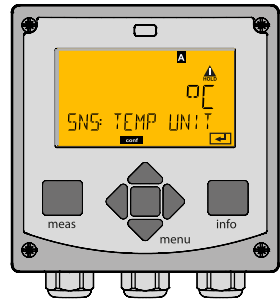

Orange:  
HOLD mode

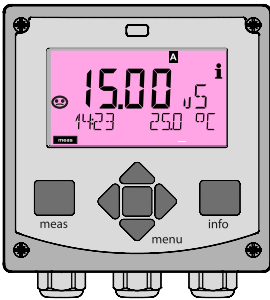

Magenta:  
Maintenance request

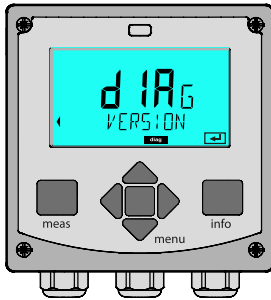

Turquoise:  
Diagnostics

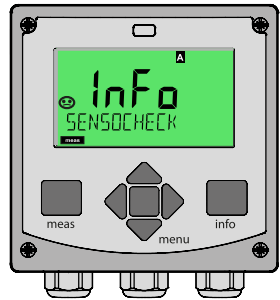

Green:  
Information texts

## **Diagnostics**

Display of calibration data, display of sensor data, performing a device self-test, viewing the logbook entries, display of hardware/software versions of the individual components. The logbook (TAN SW-A002) can store 100 events (00...99). They can be displayed directly on the device. With AuditTrail (TAN SW-A003), the logbook can be extended to 200 entries.

## **HOLD**

Manual activation of HOLD mode, e.g. for servicing. The signal outputs adopt a defined state.

## **Calibration**

Every sensor has typical characteristic values. Calibration is required to supply a correct measured value. The device checks which value the sensor delivers when measuring in a known solution. When there is a deviation, the device can be "adjusted". In that case, the device displays the "actual" value and internally corrects the measurement error of the sensor. During calibration the device is in HOLD mode.

**During calibration the device remains in the HOLD mode until it is stopped by the operator.**

## **Configuration**

The analyzer must be configured for the respective measurement task. In the "Configuration" mode you select the connected sensor, the measuring range to be transmitted, and the conditions for warning and alarm messages. During configuration the device is in HOLD mode.

**Configuration mode is automatically exited 20 minutes after the last keystroke. The device returns to measuring mode.**

## **Service**

Maintenance functions (current source), passcode assignment, reset to factory settings, enabling of options (TAN).

# Menu Structure of Modes and Functions

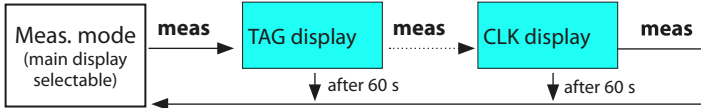

Pressing the **menu** key (down arrow) opens the selection menu.  
 Select the menu group using the left/right arrow keys.  
 Pressing **enter** opens a menu item. Press **meas** to return.

DIAG

CALDATA	Display of calibration data
SENSOR	Display of sensor data
SELFTEST	Self test: RAM, ROM, EEPROM, module
LOGBOOK	Logbook: 100 events with date and time
MONITOR	Display of direct, uncorrected sensor signals
VERSION	Display of software version, model designation, serial number

HOLD

Manual activation of HOLD mode, e.g. for sensor replacement.  
 The signal outputs behave as configured (e.g. last measured value, 21 mA)

CAL

CAL_SOL	Calibration with calibration solution
CAL_CELL	Calibration by entry of cell constant
P_CAL	Product calibration
CAL_RTD	Adjustment of temperature probe

CONF

PARSET A	Configuring parameter set A
PARSET B	Configuring parameter set B

SERVICE

(Access via code, factory setting: 5555)

MONITOR	Display of measured values for validation (simulators)
OUT1	Current source, output 1
OUT2	Current source, output 2
CODES	Specifying access codes for operating modes
DEFAULT	Reset to factory setting
OPTION	Enabling an option via TAN

The HOLD mode is a safety state during configuration and calibration. Output current is frozen (LAST) or set to a fixed value (FIX). The HOLD mode is indicated by orange display backlighting.

**HOLD mode**, display icon:



## Output signal response

- **LAST:** The output current is frozen at its last value. Recommended for short configuration procedures. The process should not change decisively during configuration. Changes are not noticed with this setting!
- **FIX:** The output current is set to a value that is noticeably different from the process value to signal the control system that the device is being worked at.

## Output signal during HOLD:

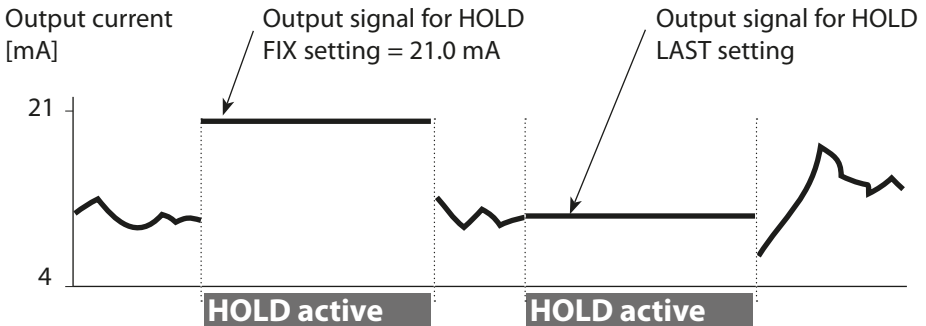

## Terminating the HOLD mode

The HOLD mode is ended by switching to measuring mode (hold **meas** key depressed). The display reads “Good Bye”, after that, the HOLD mode is exited.

When the calibration mode is exited, a confirmation prompt ensures that the installation is ready for operation (e.g.: sensor reinstalled, located in process).

# Alarm

## External activation of HOLD (SW-A005)

The HOLD mode can be activated from outside by sending a signal to the HOLD input (e.g. from the process control system).

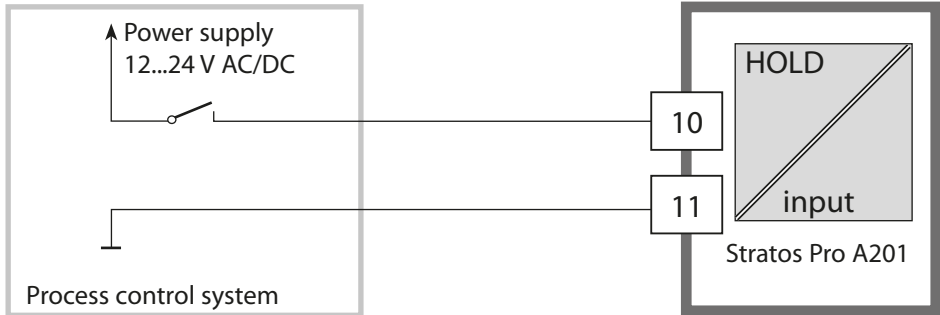

HOLD inactive	0...2 V AC/DC
HOLD active	10...30 V AC/DC

## Manual activation of HOLD

The HOLD mode can be activated manually from the HOLD menu. This allows checking or replacing a sensor, for example, without provoking unintended reactions of outputs.

Press **meas** key to return to selection menu.

## Alarm

When an error has occurred, **Err xx** is displayed immediately. Only after expiry of a user-defined delay time will the alarm be registered and entered in the logbook.

During an alarm the display blinks, the display backlighting turns **red**.

Error messages can also be signaled by a 22 mA output current (see Configuration).

2 sec after the failure event is corrected, the alarm status will be deleted.



# Alarm and HOLD Messages

Message	Released by	Cause
Alarm (22 mA)	Sensocheck	Polarization / Cable
	Error messages	Flow (CONTROL input) ERR 10: Conductance > 3500 mS
HOLD (Last/Fix)	HOLD	HOLD via menu or input
	CONF	Configuration
	CAL	Calibration
	SERVICE	Service

## Generating a message via the CONTROL input (TAN SW-A005) (min. flow / max. flow)

The CONTROL input can be used for parameter set selection or for flow measurement (pulse principle), depending on its assignment in the "Configuration" menu.

When preset to flow measurement

**CONF/CNTR\_IN/CONTROL = FLOW**

an alarm can be generated when the measured flow exceeds a specified range:

**CONF/ALA/FLOW CNTR = ON**

**CONF/ALA/FLOW min** (specify value, default: 5 liters/h)

**CONF/ALA/FLOW max** (specify value, default: 25 liters/h)

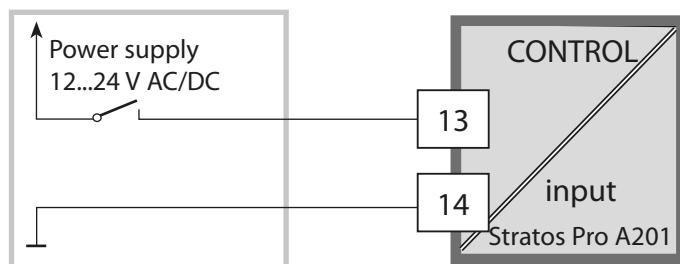

# Configuration

**⚠ CAUTION!** Incorrect parameter settings or adjustments can result in incorrect outputs. Stratos Pro must therefore be commissioned by a system specialist, all its parameters must be set, and it must be fully adjusted. For detailed information on parameter setting and adjustment, see the user manual

## Menu Structure of Configuration

The device provides 2 parameter sets "A" and "B". By switching between the parameter sets you can adapt the device to different measurement situations, for example. Parameter set "B" only permits setting of process-related parameters.

The configuration steps are assigned to different menu groups.















With the left/right arrow keys you can jump between the individual menu groups.

Each menu group contains menu items for setting the parameters.

Pressing **enter** opens a menu item. Use the arrow keys to edit a value.

Press **enter** to confirm/save the settings.

Return to measurement: Hold **meas** key depressed (> 2 s).

Select menu group	Menu group	Code	Display	Select menu item
	Sensor selection	SNS:		 <b>enter</b>  <b>enter</b>  <b>enter</b>  <b>enter</b>
		Menu item 1		
		⋮		
		Menu item ...		
▶ 	Current output 1	OT1:		
▶ 	Current output 2	OT2:		
▶ 	Compensation	COR:		
	...	...		
▶ 	Display backlighting	DSP:		

## Parameter Set A/B: Configurable Menu Groups

Menu group	Parameter set A	Parameter set B
SENSOR	Sensor selection	---
OUT1	Current output 1	Current output 1
OUT2	Current output 2	Current output 2
CORRECTION	Compensation	Compensation
CNTR_IN	Control input	---
ALARM	Alarm mode	Alarm mode
PARSET	Parameter set selection	---
CLOCK	Setting the clock	---
TAG	TAG of measuring point	TAG of measuring point
GROUP	GROUP of measuring points	GROUP of measuring points
DISPLAY	Display backlighting	---

# Configuration

## Parameter Set Selection

**Note:** Manual selection of parameter sets must have been preset in the CONFIG > PARSET menu. Default setting is fixed parameter set A. Wrong settings change the measurement properties!

### Manual Switchover of Parameter Sets A/B

Display	Action
	To switch between parameter sets: Press <b>meas.</b>
	PARSET blinks in the lower line. Select parameter set using ◀ and ▶ keys
	Press <b>enter</b> to confirm. Cancel by pressing <b>meas.</b>

### External Switchover of Parameter Sets A/B (TAN SW-A005)

You can switch between parameter sets A and B by applying a signal to the CONTROL input (parameter setting: CONTR-IN > PARSET).



Parameter set A active	0...2 V AC/DC
Parameter set B active	10...30 V AC/DC

Configuration		Choices	Default
<b>SENSOR</b>			
SNS:		2-ELECTRODE 4-ELECTRODE MEMOSENS	2-ELECTRODE
2-EL / 4-EL	CELLFACTOR <sup>1)</sup>	00.0000 - 19.9999 c	01.0000 c
MEAS MODE		Cond Conc % Sal ‰ USP µS/cm	Cond
Cond	MEAS RANGE <sup>2)</sup>	x.xxx µS/cm xx.xx µS/cm xxx.x µS/cm xxxx µS/cm x.xxx mS/cm xx.xx mS/cm xxx.x mS/cm x.xxx S/m xx.xx S/m xx.xx MΩ	xxx.x mS/cm
Conc	Solution	-01- (NaCl) -02- (HCl) -03- (NaOH) -04- (H2SO4) -05- (HNO3) -06- (H2SO4) -07- (HCl) -08- (HNO3) -09- (H2SO4) -10- (NaOH) -U1-	-01- (NaCl)

- 1) With Memosens, the cell constant is automatically loaded from the sensor. When switching from Memosens to 2-/4-electrode sensor, the cell constant is set to the default value 01.0000 c and then must be entered manually.
- 2) The range selection allows selecting the maximum resolution. If the upper limit of this range is exceeded, the device automatically switches to the next higher range.

# Configuration

Configuration		Choices	Default	
<b>SENSOR</b>				
SNS:	TEMP UNIT		°C / °F	°C
	TEMPERATURE		AUTO, MAN, EXT (EXT. only with TAN option SW-A005)	AUTO
	AUTO	RTD TYPE <sup>1)</sup>	100 PT 1000 PT 8.55 NTC 30 NTC Ni100	1000 PT
	MAN	TEMPERATURE	-50 ... 250 °C (-58 ... 482 °F)	025.0 °C (077.0 °F)
	CAL-POINTS <sup>1)</sup>		-01, -02-, -03-	-01-
	CIP COUNT		ON/OFF	OFF
			ON	0 ... 9999 CYCLES
	SIP COUNT		ON/OFF	OFF
			ON	0 ... 9999 CYCLES
	CHECK TAG		ON/OFF	OFF
CHECK GROUP		ON/OFF	OFF	

1) Only with 2-ELECTRODE/4-ELECTRODE selected.

Configuration		Choices	Default	
<b>Output 1 (OUT1)</b>				
OT1:	CHANNEL		Cond/TMP	Cond
	OUTPUT		LIN / BiLIN / LOG	LIN
	LIN	BEGIN 4 mA	xxxx	000.0 mS/cm
		END 20 mA	xxxx	100.0 mS/cm
	BiLIN	BEGIN 4 mA	xxxx	000.0 mS/cm
		END 20 mA	xxxx	100.0 mS/cm
		CORNER X	Input range: selected CHANNEL Vertex X: $BEGIN \leq CORNER X \leq END$ (rising) $BEGIN \geq CORNER X \geq END$ (falling)	
		CORNER Y	Input range: selected CHANNEL Default: 12 mA Vertex Y: (0) $4 \text{ mA} \leq CORNER Y \leq 20 \text{ mA}$	
	LOG	BEGIN 4 mA	Decades	
		END 20 mA	Decades	
	TMP °C	BEGIN 4 mA	-50...250 °C	
		END 20 mA	-50...250 °C	
	TMP °F	BEGIN 4 mA	-58...482 °F	
		END 20 mA	-58...482 °F	
	FILTERTIME		0...120 SEC	0000 SEC
	22 mA FAIL		ON/OFF	OFF
	22 mA FACE		ON/OFF	OFF
	HOLD MODE		LAST/FIX	LAST
	FIX	HOLD-FIX	04.00...22.00 mA	021.0 mA
<b>Output 2 (OUT2)</b>				
OT2:	CHANNEL		Cond/TMP	TMP
	... other steps like output 1			

# Configuration

Configuration		Choices	Default		
<b>Temperature compensation (CORRECTION)</b>					
COR:	TC SELECT		OFF LIN, NLF, NaCl HCl, NH3, NaOH	OFF	
	LIN	TC LIQUID	00.00 ... 19.99%/K	00.00%/K	
		REF TEMP	000.0 ... 199.9 °C	025.0 °C	
	TEMP EXT *)		ON/OFF	OFF	
		I-INPUT		0–20 mA / 4–20 mA	4–20 mA
		°C	BEGIN 4 mA	–50...250 °C	000.0 °C
			END 20 mA	–50...250 °C	100.0 °C
		°F	BEGIN 4 mA	–58...482 °F	
END 20 mA	–58...482 °F				
<b>Control input (CNTR_IN)</b>					
IN:	CONTROL		Parameter set switchover (PARSET) or flow measurement (FLOW)	PARSET	
	FLOW	FLOW ADJUST	12000 pulses/liter	0 ... 20000 pulses/liter	

## Monitoring the Sensor Lines for Breakage

The sensor lines are monitored for breakage when the temperature is used for calculating the conductivity or concentration. If the sensor or line is broken, an alarm will be generated (output current FIX or 22 mA, depending on the configuration).

If you want to output a conductivity value that is independent of the measured temperature (uncompensated), you can monitor the sensor lines for breakage by setting "TEMP CHECK" to "ON" in the Alarm menu.

(See following page, ALARM menu)

\*) with TAN option SW-A005 and SENSOR "TEMP EXT" selected



Configuration		Choices	Default
<b>Alarm (ALARM)</b>			
ALA:	DELAYTIME	0...600 SEC	0010 SEC
	SENSOCHECK	ON/OFF	OFF
	TEMP CHECK	ON/OFF	OFF
	FLOW CNTR *)	ON/OFF	OFF
	ON	FLOW MIN **)	0 ... 99.9 L/h
	FLOW MAX**)	0 ... 99.9 L/h	025.0 L/h
<b>Parameter set (PARSET)</b>			
PAR:	Select fixed parameter set (A) or switch between A/B via control input or manually in measuring mode	PARSET FIX / CNTR INPUT / MANUAL	PARSET FIX (fixed parameter set A)
<b>Real-time clock (CLOCK)</b>			
CLK:	FORMAT	24 h / 12 h	24 h
	24 h	TIME hh/mm	00..23:00...59
	12 h	TIME hh/mm	00 ... 12:59 AM / 01 ... 11:59 PM
		DAY/MONTH	01...31/01...12
		YEAR	2000...2099
<b>Measuring points (TAG / GROUP)</b>			
TAG:	(Input in text line)	A...Z, 0...9, - + < > ? / @	
GROUP:	(Input in text line)	0000...9999	0000
<b>Display backlighting (DISPLAY)</b>			
DSP:	BACKLIGHT	On, Off	On

\* These menu items appear only if selected.

\*\* Hysteresis fixed at 5% of threshold value

# Configuration (Template for Copy)

Parameter	Parameter set A	Parameter set B
SNS: Sensor type		--- *)
SNS: Cell constant		---
SNS: Measuring mode		---
SNS: Measuring range		---
SNS: Concentration determination		---
SNS: Temperature unit		---
SNS: Temperature detection		---
SNS: Manual temp		---
SNS: RTD type		---
SNS: CIP counter		---
SNS: SIP counter		---
SNS: Cal points		---
SNS: CHECK TAG		---
SNS: CHECK GROUP		---
OT1: Process variable		
OT1: Lin/bilin/log output		
OT1: Current start		
OT1: Current end		
OT1: Vertex X (bilinear curve only)		
OT1: Vertex X (bilinear curve only)		
OT1: Filter time		
OT1: FAIL 22 mA (error messages)		
OT1: FACE 22 mA (Sensoface messages)		
OT1: HOLD mode		
OT1: HOLD FIX current		

# Configuration (Template for Copy)

Parameter	Set A	Set B
OT2: Process variable		
OT2: Lin/bilin/log output		
OT2: Current start		
OT2: Current end		
OT2: Vertex X (bilinear curve only)		
OT2: Vertex Y (bilinear curve only)		
OT2: Filter time		
OT2: FAIL 22 mA (error messages)		
OT2: FACE 22 mA (Sensoface messages)		
OT2: HOLD mode		
OT2: HOLD FIX current		
COR: TC SELECT		
COR: Temp coefficient		
COR: Reference temperature		
COR: Ext. temp input		
COR: Current range		
COR: Current start		
COR: Current end		
IN: Parameter set A/B or flow		
IN: (Flow meter) Adjusting pulses/liter		
ALA: Delay		
ALA: Sensocheck on/off		
ALA: Tempcheck on/off		
ALA: Flow control FLOW CNTR on/off		
ALA: Minimum flow (hysteresis fixed at 5 %)		
ALA: Maximum flow (hysteresis fixed at 5 %)		
PAR: Parameter set selection		---*)
CLK: Time format		---
TAG: Measuring point (tag number)		
GROUP: Group of measuring points		
DISPLAY: Display backlighting		---

\*) These parameters cannot be adjusted in parameter set B, the values are the same as in parameter set A.

# Configuration

## Sensor

### Selecting the Parameters

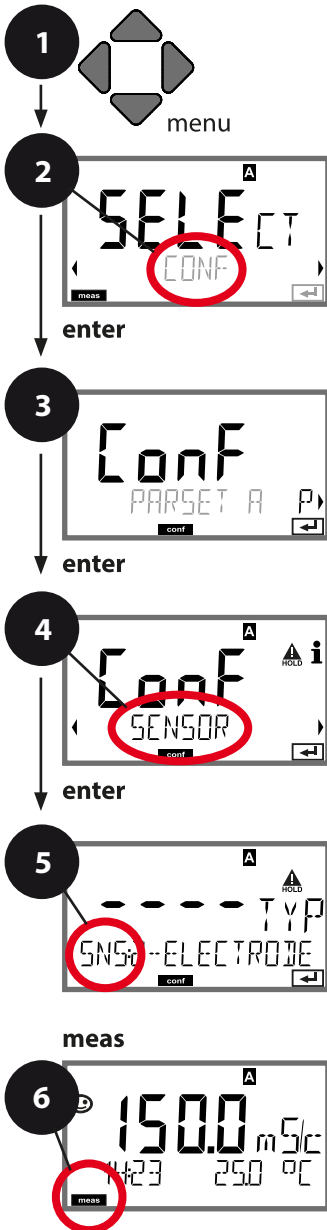

- 1) Press **menu** key.
- 2) Select **CONF** using ◀ ▶, press **enter**.
- 3) Select parameter set using ◀ ▶ keys, press **enter**.
- 4) Select **SENSOR** menu using ◀ ▶ keys, press **enter**.
- 5) All items of this menu group are indicated by the "SNS:" code.  
Press **enter** to select menu, edit using arrow keys (see next page). Confirm (and proceed) by pressing **enter**.
- 6) Exit: Press **meas** key until the [meas] mode indicator is displayed.

Select sensor type	enter
Enter cell constant	enter
Select measuring mode	enter
Select measuring range	enter
Concentration determination	
Temperature unit	
Temperature detection	
Select type of temp probe	
Select calibration points	
Cleaning cycles	
Sterilization cycles	
CHECK TAG	
CHECK GROUP	

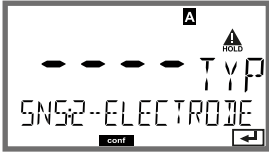
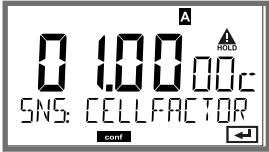
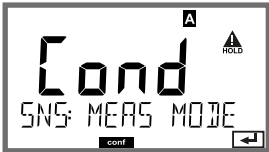
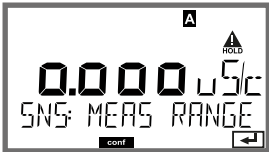
Menu item	Action	Choices
Select sensor type 	Select sensor type using ▲ ▼ keys.  Press <b>enter</b> to confirm.	<b>2-ELECTRODE</b> 4-ELECTRODE MEMOSENS
Enter cell constant 	Modify digit using ▲ ▼ keys, select next digit using ◀ ▶ keys.  Press <b>enter</b> to confirm.	00.0000...19.9999 c <b>(01.0000 c)</b>
Select meas. mode 	Select desired measuring mode using ▲ ▼ keys.  Press <b>enter</b> to confirm.	<b>Cond</b> Conc % Sal ‰ USP μS/cm
Select range 	<b>For cond measurement only</b>  Select desired range using ▲ ▼ keys.  Press <b>enter</b> to confirm.	x.xxx μS/cm, xx.xx μS/cm xxx.x μS/cm, xxxx μS/cm x.xxx mS/cm, xx.xx mS/cm <b>xxx.x mS/cm</b> , x.xxx S/m xx.xx S/m, xx.xx MΩ

# Configuration

## Sensor

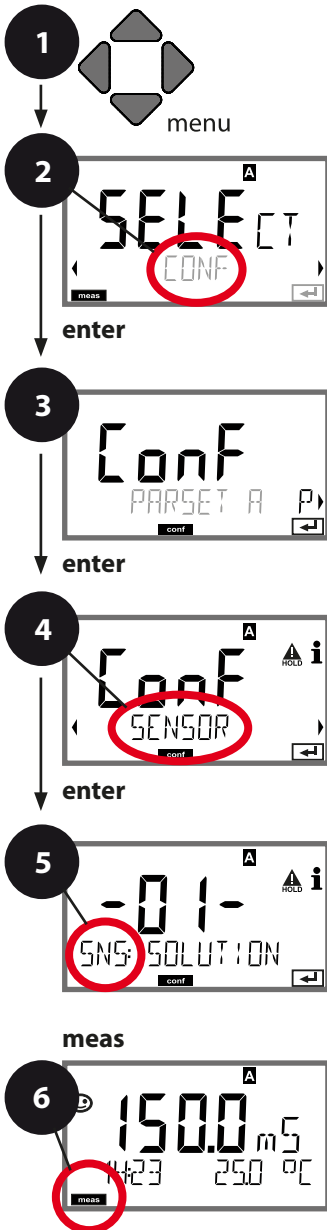

### Selection: Concentration Determination



- 1) Press **menu** key.
- 2) Select **CONF** using ◀ ▶ keys, press **enter**.
- 3) Select parameter set using ◀ ▶, press **enter**.
- 4) Select **SENSOR** menu using ◀ ▶ keys, press **enter**.
- 5) All items of this menu group are indicated by the "SNS:" code.  
Press **enter** to select menu, edit using arrow keys (see next page). Confirm (and proceed) using **enter**.
- 6) Exit: Press **meas** key until the [meas] mode indicator is displayed.

5

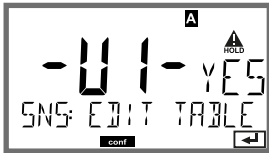
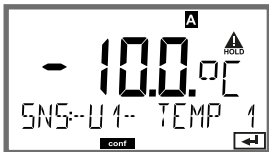
Select sensor type	enter
Enter cell constant	enter
Select measuring mode	enter
Select measuring range	enter
Concentration determination	
Temperature unit	
Temperature detection	
Select type of temp probe	
Select calibration points	
Cleaning cycles	
Sterilization cycles	
CHECK TAG	
CHECK GROUP	

Menu item	Action	Selection
Concentration determination	<p><b>For concentration measurement only</b></p> <p>Use the arrow keys ▲ ▼ to select the desired concentration solution.</p> <p>Press <b>enter</b> to confirm.</p>	<p><b>-01- (NaCl)</b>, -02- (HCl),            -03- (NaOH), -04- (H<sub>2</sub>SO<sub>4</sub>),            -05- (HNO<sub>3</sub>), -06- (H<sub>2</sub>SO<sub>4</sub>),            -07- (HCl), -08- (HNO<sub>3</sub>),            -09- (H<sub>2</sub>SO<sub>4</sub>), -10- (NaOH),            -U1-</p>
<p><b>-U1-: Specifying a Concentration Solution for Conductivity Measurement</b></p> <p>To specify a custom solution, 5 concentration values are entered in a matrix together with 5 temperature values 1 ... 5. First enter the 5 temperature values, then the corresponding conductivity values for each of the concentrations 1 ... 5. These solutions are then available as "U1" in addition to the default standard solutions.</p>		
	<p>Press <b>enter</b> to confirm</p>	
	<p>Use the arrow keys ▲ ▼ ◀ ▶ to enter temperature values 1 ... 5.</p> <p>Press <b>enter</b> to confirm.</p>	<p>Input range:            -50...250 °C /            -58...482 °F</p>
	<p>Use the arrow keys ▲ ▼ ◀ ▶ to enter concentration value 1.</p> <p>Press <b>enter</b> to confirm.</p>	
	<p>For concentration value 1:            Use the arrow keys ▲ ▼ ◀ ▶ to enter conductivity values for temperatures 1 ... 5.</p> <p>Press <b>enter</b> to confirm.</p>	

# Configuration

## Sensor

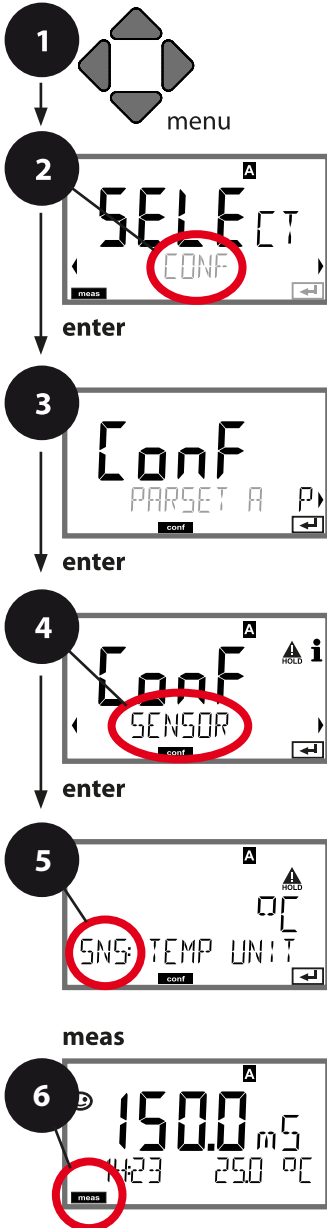

Select: Temperature unit, temperature detection, type of temp probe



- 1) Press **menu** key.
- 2) Select **CONF** using ◀ ▶ keys, press **enter**.
- 3) Select parameter set using ◀ ▶, press **enter**.
- 4) Select **SENSOR** menu using ◀ ▶ keys, press **enter**.
- 5) All items of this menu group are indicated by the "SNS:" code.  
Press **enter** to select menu, edit using arrow keys (see next page). Confirm (and proceed) using **enter**.
- 6) Exit: Press **meas** key until the [meas] mode indicator is displayed.

Select sensor type	5	enter
Enter cell constant		↻
Select measuring mode		↻
Select measuring range		
Concentration determination		
Temperature unit		
Temperature detection		
Select type of temp probe		
Select calibration points		
Cleaning cycles		
Sterilization cycles		
CHECK TAG		
CHECK GROUP		

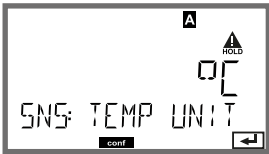
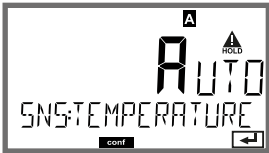
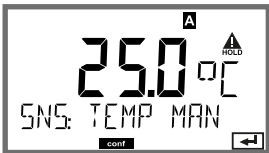
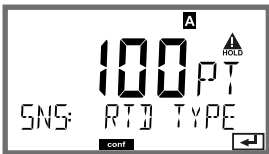

Menu item	Action	Selection
Temperature unit 	Select °C or °F using the ▲ ▼ arrow keys.  Confirm with <b>enter</b>	°C / °F
Temperature detection 	Select the mode using the ▲ ▼ arrow keys: AUTO: Measured by sensor MAN: Direct input of temperature, no measurement (see next step) EXT: Temperature specified via current input (only if TAN E enabled) Confirm with <b>enter</b>	<b>AUTO</b> MAN EXT
(Manual temperature) 	Modify the digit using the ▲ ▼ arrow keys, select another digit using the ◀ ▶ arrow keys. Confirm with <b>enter</b>	-50...250 °C (-58...482 °F)
Select type of temp probe 	(not for Memosens) Select the type of temperature probe using the ▲ ▼ arrow keys.  Confirm with <b>enter</b>	<b>1000 PT</b> 100 PT 30 NTC 8.55 NTC Ni100
Select calibration points 	(not for Memosens) Select the number of calibration points using the ▲ ▼ arrow keys.  Confirm with <b>enter</b>	<b>-01-</b> -02- -03-

# Configuration

## Sensor

### Adjust: Cleaning cycles, sterilization cycles

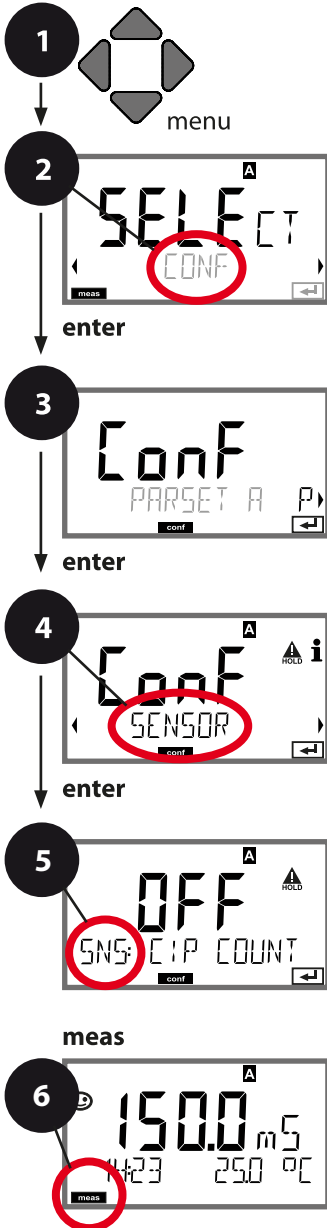

- 1) Press **menu** key.
- 2) Select **CONF** using ◀ ▶ keys, press **enter**.
- 3) Select parameter set using ◀ ▶, press **enter**.
- 4) Select **SENSOR** menu using ◀ ▶ keys, press **enter**.
- 5) All items of this menu group are indicated by the "SNS:" code.  
Press **enter** to select menu, edit using arrow keys (see next page). Confirm (and proceed) using **enter**.
- 6) Exit: Press **meas** key until the [meas] mode indicator is displayed.

Select sensor type	5	enter
Enter cell constant		↻
Select measuring mode		↻
Select measuring range		
Concentration determination		
Temperature unit		
Temperature detection		
Select type of temp probe		
Select calibration points		
Cleaning cycles		
Sterilization cycles		
CHECK TAG		
CHECK GROUP		

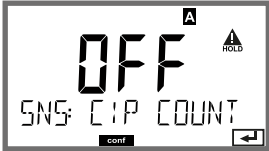
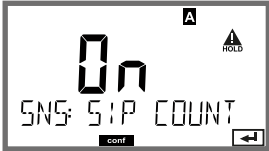
Menu item	Action	Choices
<b>CIP / SIP</b>		
Cleaning cycles 	Select ON or OFF using ▲ ▼ keys. Activates/deactivates logging in extended logbook (TAN SW-A003). Press <b>enter</b> to confirm.	ON/OFF
Sterilization cycles 	Select ON or OFF using ▲ ▼ keys. Activates/deactivates logging in extended logbook (TAN SW-A003). Press <b>enter</b> to confirm.	ON/OFF

Logging the cleaning and sterilization cycles with connected sensor helps measuring the load on the sensor.

Suitable for biochemical applications (process temp approx.

0 ... 50 °C / 32 ... 122 °F, CIP temp > 55 °C / 131 °F,

SIP temp > 115 °C / 239 °F).

**Note:**

A CIP or SIP cycle is only entered into the extended logbook (TAN SW-A003) 2 hours after the start to ensure that the cycle is complete. With Memosens, an entry is also made in the sensor.

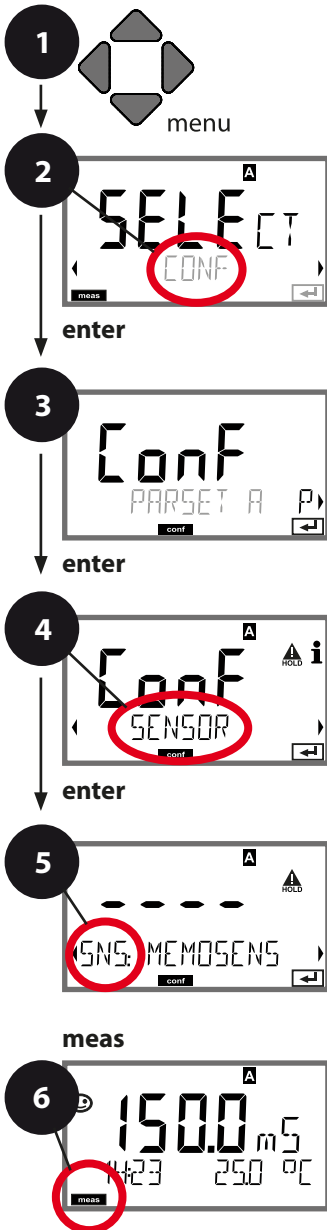

# Configuration

## Memosens Sensor Sensor Verification (TAG, GROUP)



- 1) Press **menu** key.
- 2) Select **CONF** using ◀ ▶, press **enter**.
- 3) Select parameter set using ◀ ▶ keys, press **enter**.
- 4) Select **SENSOR** menu using ◀ ▶ keys, press **enter**.
- 5) All items of this menu group are indicated by the "SNS:" code.  
Press **enter** to select menu, edit using arrow keys (see next page). Confirm (and proceed) by pressing **enter**.
- 6) Exit: Press **meas** key until the [meas] mode indicator is displayed.

	5
Select sensor type	enter
Enter cell constant	enter
Select measuring mode	enter
Select measuring range	
Concentration determination	
Temperature unit	
Temperature detection	
Select type of temp probe	
Select calibration points	
Cleaning cycles	
Sterilization cycles	
CHECK TAG	
CHECK GROUP	

Menu item	Action	Choices
<p>TAG</p> 	<p>Select ON or OFF using ▲ ▼ keys. Press <b>enter</b> to confirm.</p> <p>When switched on, the entry for "TAG" in the Memosens sensor is compared to the entry in the analyzer. If the entries differ, a message will be generated.</p>	<p>ON/OFF</p>
<p>GROUP</p> 	<p>Select ON or OFF using ▲ ▼ keys. Press <b>enter</b> to confirm.</p> <p>Function as described above</p>	<p>ON/OFF</p>

## Sensor Verification (TAG, GROUP)

When Memosens sensors are calibrated in the lab, it is often useful and sometimes even mandatory that these sensors will be operated again at the same measuring points or at a defined group of measuring points. To ensure this, you can save the respective measuring point (TAG) or group of measuring points (GROUP) in the sensor. TAG and GROUP can be specified by the calibration tool or automatically entered by the transmitter. When connecting an MS sensor to the transmitter, it can be checked if the sensor contains the correct TAG or belongs to the correct GROUP. If not, a message will be generated, Sensoface gets "sad", and the display backlighting turns magenta (purple). The "sad" Sensoface icon can also be signaled by a 22 mA error current. Sensor verification can be switched on in the Configuration in two steps as TAG and GROUP if required.

When no measuring point or group of measuring points is saved in the sensor, e.g., when using a new sensor, Stratos enters its own TAG and GROUP. When sensor verification is switched off, Stratos always enters its own measuring point and group. A possibly existing TAG/GROUP will be overwritten.

# Configuration

## Current Output 1

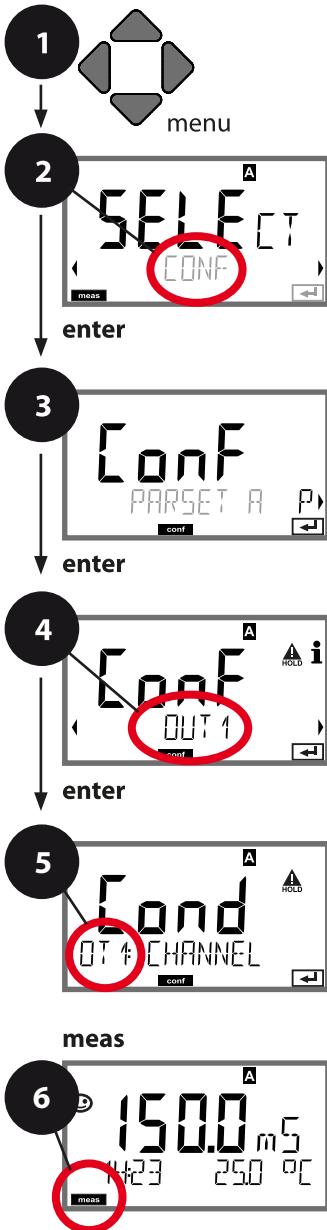

### Output current range. Process variable.



- 1) Press **menu** key.
- 2) Select **CONF** using ◀ ▶ keys, press **enter**.
- 3) Select parameter set using ◀ ▶, press **enter**.
- 4) Select **OUT1** menu using ◀ ▶ keys, press **enter**.
- 5) All items of this menu group are indicated by the "OT1:" code.  
Press **enter** to select menu, edit using arrow keys (see next page). Confirm (and proceed) using **enter**.
- 6) Exit: Press **meas** key until the [meas] mode indicator is displayed.

5

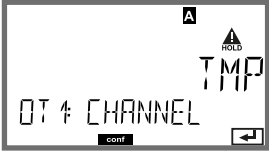
Process variable	enter
LIN/biLIN/LOG output	enter
Current start	
Current end	
Time averaging filter	
Output current for error message	
Output current for Sensoface	
Output current during HOLD	
Output current for HOLD FIX	

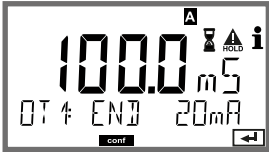
Menu item	Action	Choices
Process variable 	Select using $\blacktriangle$ $\blacktriangledown$ keys: Cond: Conductivity TMP: Temperature Press <b>enter</b> to confirm. Then select characteristic (LIN/biLIN/LOG).	Cond/TMP 
Current start 	Modify digit using $\blacktriangle$ $\blacktriangledown$ keys, select next digit using $\blacktriangleleft$ $\blacktriangleright$ keys.  Press <b>enter</b> to confirm.	Entered value applies to selected process variable/ range If the adjusted range is exceeded, the device automatically switches to the next higher range (Autorange)
Current end 	Enter value using $\blacktriangle$ $\blacktriangledown$ $\blacktriangleleft$ $\blacktriangleright$ keys.  Press <b>enter</b> to confirm.	Entered value applies to selected process variable/ range If the adjusted range is exceeded, the device automatically switches to the next higher range (Autorange)

### Assignment of measured values: Current start and current end

Example 1: Range 0...200 mS/cm

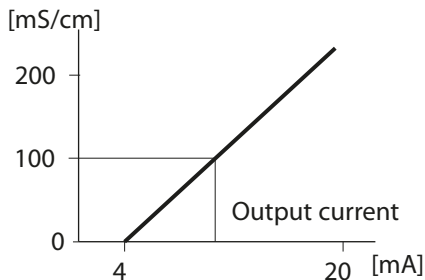

Example 2: Range 100...200 mS/cm

Advantage: Higher resolution in range of interest

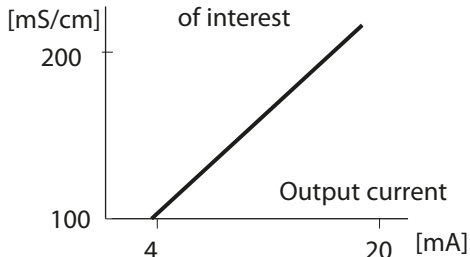

# Configuration

## Current Output 1

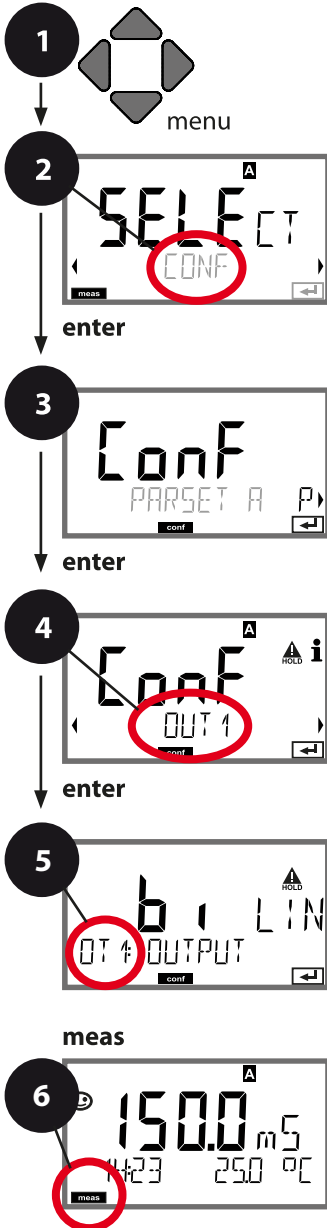

### Output current curve, bilinear



- 1) Press **menu** key.
- 2) Select **CONF** using **◀ ▶** keys, press **enter**.
- 3) Select parameter set using **◀ ▶**, press **enter**.
- 4) Select **OUT1** menu using **◀ ▶** keys, press **enter**.
- 5) All items of this menu group are indicated by the "OT1:" code.  
Press **enter** to select menu, edit using arrow keys (see next page). Confirm (and proceed) using **enter**.
- 6) Exit: Press **meas** key until the [meas] mode indicator is displayed.

	<b>5</b>
Process variable	<b>enter</b>
LIN/biLIN/LOG output	<b>enter</b>
Current start	
Current end	
Bilinear: Vertex X	
Bilinear: Vertex Y	
Time averaging filter	
Output current for error message	
Output current for Sensoface	
Output current during HOLD	
Output current for HOLD FIX	

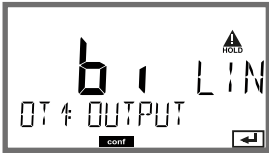

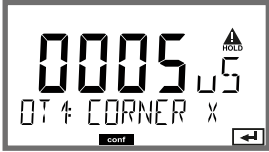
Menu item	Action	Choices
Output current curve 	Select using ▲ ▼ keys. Press <b>enter</b> to confirm.	<b>LIN</b> Linear characteristic biLIN Bilinear curve LOG Logarithmic curve
Current start and current end 	Enter value using ▲ ▼ ◀ ▶ keys.  Press <b>enter</b> to confirm.	Entered value applies to selected process variable/range If the adjusted range is exceeded, the device automatically switches to the next higher range (Autorange)
Bilinear curve: Vertex X/Y 	Enter value using ▲ ▼ ◀ ▶ keys.  Press <b>enter</b> to confirm.	Entered value applies to selected vertex of bilinear curve "Corner X" (process variable) and "Corner Y" (output current) – see figure below.

### Vertex of bilinear curve

Output current

[mA]

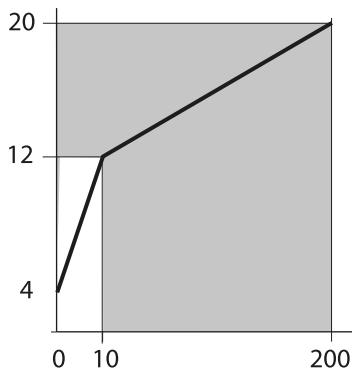

Example:

Current range 4 ... 20 mA,

Current start: 0 μS/cm

Current end: 200 μS/cm

Vertex:

"CORNER X": 10 μS/cm (process variable)

"CORNER Y": 12 mA (output current)

Result: The output current change in the range 0 ... 10 μS/cm is much greater than in the range 10 ... 200 μS/cm.

Process variable  
[μS/cm]

# Logarithmic Curve

Nonlinear output current characteristic: allows measurements over several decades, e.g. measuring very low values with a high resolution and high values with a low resolution.

Parameters required: Start and end value

### Possible start and end values

The start value must be at least one decade lower than the end value.

Start value and end value must be specified in the same units (either in  $\mu\text{S/cm}$  or in  $\text{S/m}$ , see listing):

1.0 $\mu\text{S/cm}$	
10.0 $\mu\text{S/cm}$	0.001 $\text{S/m}$
100.0 $\mu\text{S/cm}$	0.01 $\text{S/m}$
1.0 $\text{mS/cm}$	0.1 $\text{S/m}$
10.0 $\text{mS/cm}$	1.0 $\text{S/m}$
100.0 $\text{mS/cm}$	10.0 $\text{S/m}$
1000 $\text{mS/cm}$	100 $\text{S/m}$

### The start value

is the next decade value below the lowest measured value.

### The end value

is the next decade value above the highest measured value.

The number of decades results from:

$$\text{Number of decades} = \log(\text{end value}) - \log(\text{start value})$$

The output current value is defined as follows:

$$\text{Output current} = 16 \text{ mA} * \frac{\log(\text{measured value}) - \log(\text{start value})}{\text{Number of decades}} + 4 \text{ mA}$$

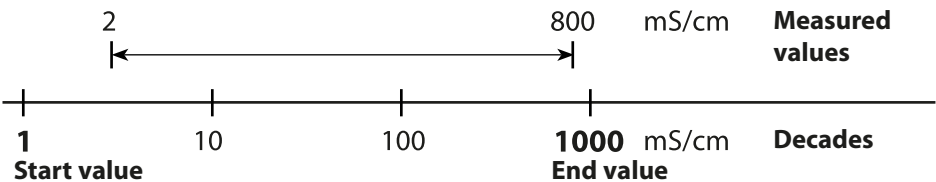

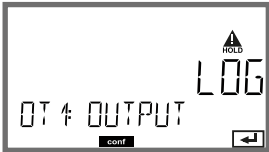
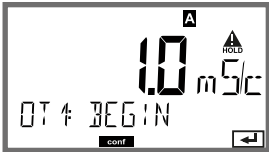
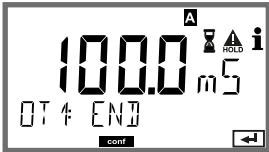
Menu item	Action	Choices
Logarithmic curve of output current  	Select using ▲ ▼ keys. Press <b>enter</b> to confirm.	<b>LOG</b> Logarithmic curve  biLIN Bilinear curve  LIN Linear characteristic
Start value  	Enter value using ▲ ▼ ◀ ▶ keys.  Press <b>enter</b> to confirm.	Start value of logarithmic output curve
End value  	Enter value using ▲ ▼ ◀ ▶ keys.  Press <b>enter</b> to confirm.	End value of logarithmic output curve

### Possible start and end values for the logarithmic curve

#### S/cm:

1.0  $\mu\text{S/cm}$ , 10.0  $\mu\text{S/cm}$ , 100.0  $\mu\text{S/cm}$ ,  
1.0  $\text{mS/cm}$ , 10.0  $\text{mS/cm}$ , 100.0  $\text{mS/cm}$ , 1000  $\text{mS/cm}$

#### S/m:

0.001  $\text{S/m}$ , 0.01  $\text{S/m}$ , 0.1  $\text{S/m}$ , 1.0  $\text{S/m}$ , 10.0  $\text{S/m}$ , 100  $\text{S/m}$

# Configuration

## Current Output 1

### Adjusting the time interval of the output filter

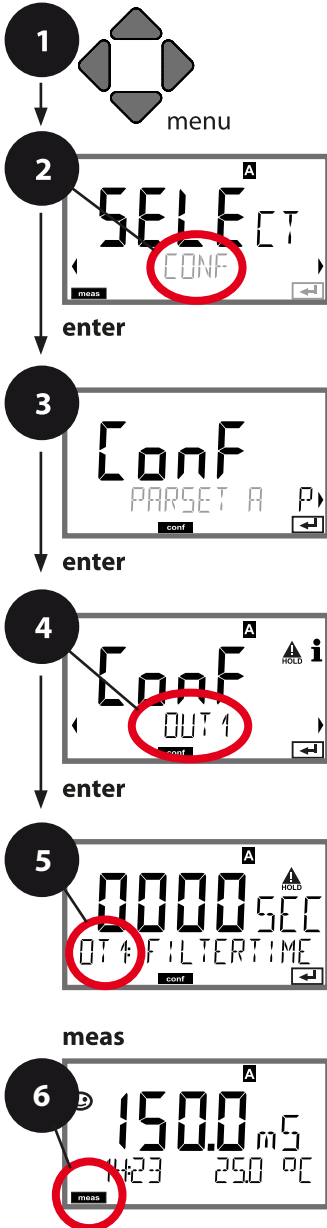

- 1) Press **menu** key.
- 2) Select **CONF** using ◀ ▶ keys, press **enter**.
- 3) Select parameter set using ◀ ▶, press **enter**.
- 4) Select **OUT1** menu using ◀ ▶ keys, press **enter**.
- 5) All items of this menu group are indicated by the "OT1:" code.  
Press **enter** to select menu, edit using arrow keys (see next page). Confirm (and proceed) using **enter**.
- 6) Exit: Press **meas** key until the [meas] mode indicator is displayed.

	<b>5</b>
Process variable	enter
LIN/biLIN/LOG output	enter
Current start	
Current end	
Time averaging filter	
Output current for error message	
Output current for Sensoface	
Output current during HOLD	
Output current for HOLD FIX	

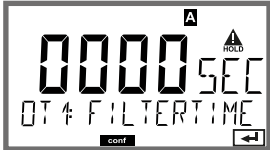
Menu item	Action	Choices
Time averaging filter 	Enter value using ▲ ▼ ◀ ▶ keys.  Press <b>enter</b> to confirm.	0...120 SEC (0000 SEC)

### Time averaging filter

To smoothen the current output, a low-pass filter with adjustable filter time constant can be switched on. When there is a jump at the input (100 %), the output level is at 63 % after the time interval has been reached. The time interval can be set from 0 to 120 sec. If the time interval is set to 0 sec, the current output directly follows the input.

#### Note:

The filter only acts on the current output, not on the display or the limit value!

During HOLD the filter is not applied. This prevents a jump at the output.

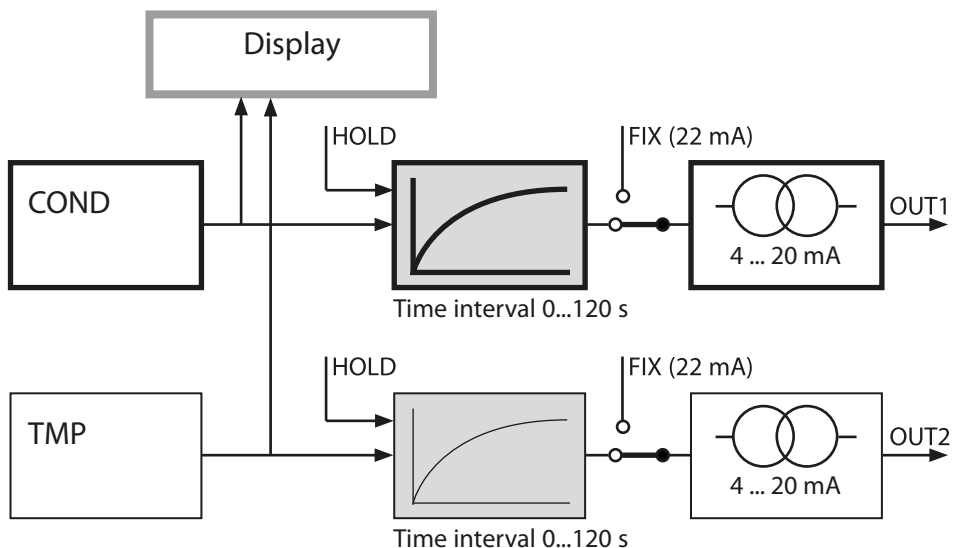

# Configuration

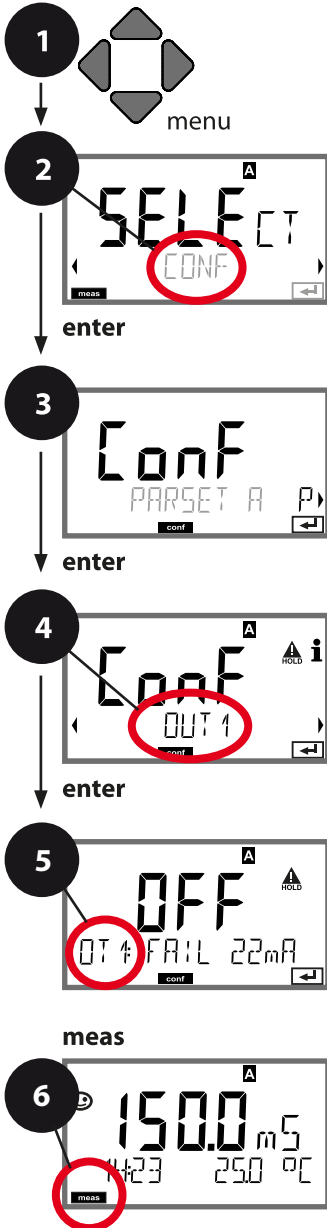

## Current Output 1

### Output current during Error and HOLD

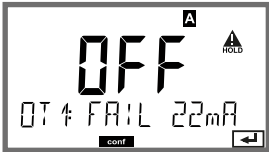
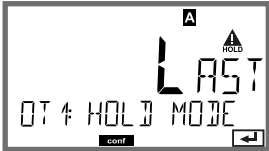

- 1) Press **menu** key.
- 2) Select **CONF** using ◀ ▶ keys, press **enter**.
- 3) Select parameter set using ◀ ▶, press **enter**.
- 4) Select **OUT1** menu using ◀ ▶ keys, press **enter**.
- 5) All items of this menu group are indicated by the "OT1:" code.  
Press **enter** to select menu, edit using arrow keys (see next page). Confirm (and proceed) using **enter**.
- 6) Exit: Press **meas** key until the [meas] mode indicator is displayed.

	5
Process variable	enter
LIN/biLIN/LOG output	enter
Current start	
Current end	
Time averaging filter	
Output current for error message	
Output current for Sensoface	
Output current during HOLD	
Output current for HOLD FIX	

Menu item	Action	Choices
Output current during error message	Select ON (22 mA for error message) or OFF using $\blacktriangle$ $\blacktriangledown$ keys. Press <b>enter</b> to confirm.	ON/OFF
		
Output current during Sensoface messages <b>OT1: FACE 22 mA</b>	Select ON or OFF using $\blacktriangle$ $\blacktriangledown$ keys. Confirm by pressing <b>enter</b>	ON/OFF
Output current during HOLD	LAST: During HOLD the last measured value is maintained at the output. FIX: During HOLD a value (to be entered) is maintained at the output. Select using $\blacktriangle$ $\blacktriangledown$ keys. Press <b>enter</b> to confirm.	LAST/FIX
		
Output current for HOLD FIX	Only with FIX selected: Enter current which is to flow at the output during HOLD Enter value using $\blacktriangle$ $\blacktriangledown$ $\blacktriangleleft$ $\blacktriangleright$ keys. Press <b>enter</b> to confirm.	04.00...22.00 mA <b>(21.00 mA)</b>
		

### Output signal during HOLD:

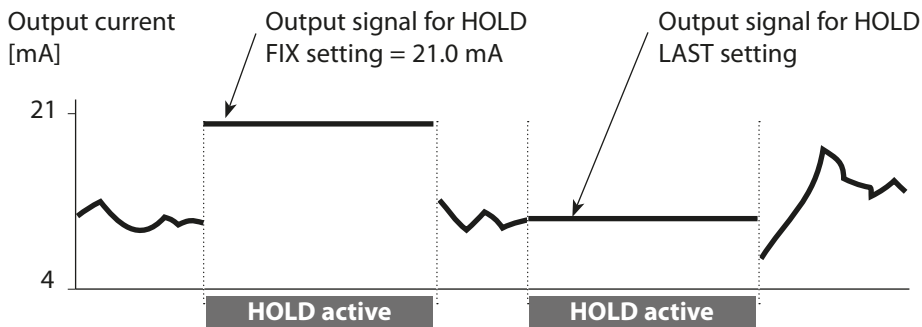

# Configuration

## Current Output 2

### Output current range. Process variable . . .

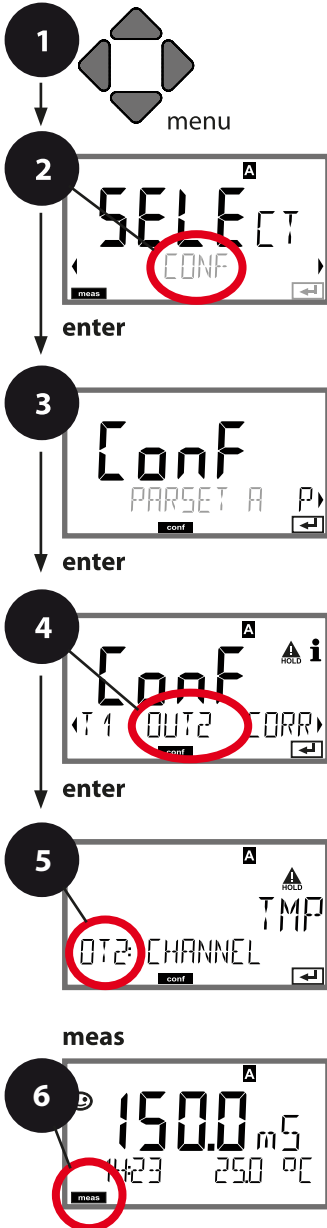

- 1) Press **menu** key.
- 2) Select **CONF** using ◀ ▶ keys, press **enter**.
- 3) Select parameter set using ◀ ▶, press **enter**.
- 4) Select **OUT2** menu using ◀ ▶ keys, press **enter**.
- 5) All items of this menu group are indicated by the "OT2:" code.  
Press **enter** to select menu, edit using arrow keys (see next page). Confirm (and proceed) using **enter**.
- 6) Exit: Press **meas** key until the [meas] mode indicator is displayed.

Process variable	enter
LIN/biLIN/LOG output	↻
Current start	↻
Current end	
Bilinear: Vertex X	
Bilinear: Vertex Y	
Time averaging filter	
Output current for error message	
Output current for Sensoface	
Output current during HOLD	
Output current for HOLD FIX	

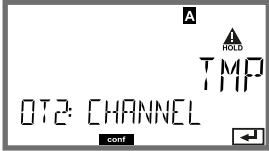

Menu item	Action	Choices
Process variable 	Select using ▲ ▼ keys: COND: Conductivity TMP: Temperature  Press <b>enter</b> to confirm.	Cond/ <b>TMP</b> Begin: 0 °C End: 100°C
<ul style="list-style-type: none"> <li>•</li> <li>•</li> <li>•</li> </ul>		

**All the following adjustments are made as for current output 1 (see there)!**

# Configuration

## Temperature Compensation

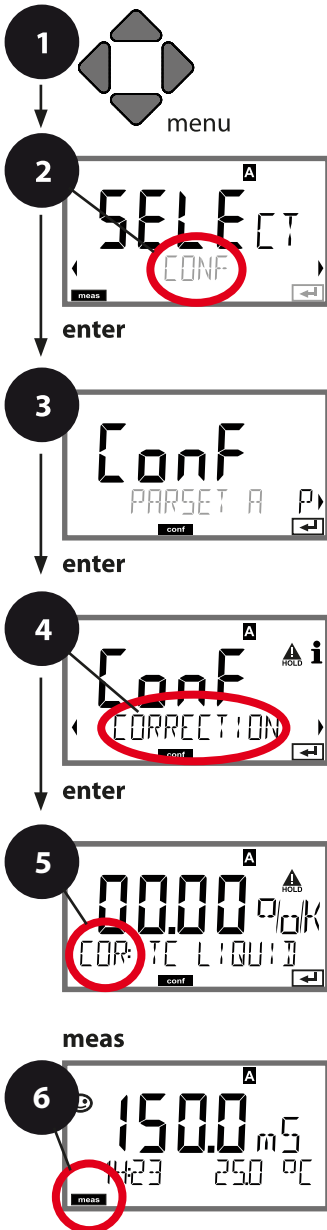

Selecting the compensation method. TC process medium.



- 1) Press **menu** key.
- 2) Select **CONF** using ◀ ▶ keys, press **enter**.
- 3) Select parameter set using ◀ ▶, press **enter**.
- 4) Select **CORRECTION** menu using ◀ ▶ keys, press **enter**.
- 5) All items of this menu group are indicated by the "COR:" code.  
Press **enter** to select menu, edit using arrow keys (see next page). Confirm (and proceed) using **enter**.
- 6) Exit: Press **meas** key until the [meas] mode indicator is displayed.

5

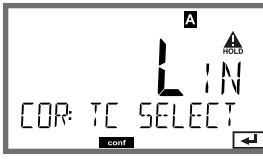
Temperature compensation	enter
Temperature compensation, process medium	enter
Enter reference temperature	enter
Current input, external temp measurement	
Current start	
Current end	

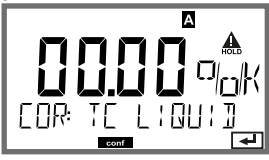
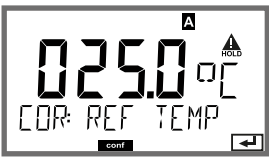
Menu item	Action	Choices
Temperature compensation	<p>Select desired compensation using <math>\blacktriangle</math> <math>\blacktriangledown</math> keys:</p> <p><b>OFF:</b> Temp compensation switched off</p> <p><b>LIN:</b> Linear temperature compensation with entry of temperature coefficient</p> <p><b>nLF:</b> Temperature compensation for natural waters to EN 27888</p> <p><b>NaCl:</b> Ultrapure water with NaCl traces (0 ... +120 °C / +32 ... +248 °F)</p> <p><b>HCl:</b> Ultrapure water with HCl traces (0 ... +120 °C / +32 ... +248 °F)</p> <p><b>NH3:</b> Ultrapure water with NH<sub>3</sub> traces (0 ... +120 °C / +32 ... +248 °F)</p> <p><b>NaOH:</b> Ultrapure water with NaOH traces (0 ... +120 °C / +32 ... +248 °F)</p> <p>Press <b>enter</b> to confirm.</p>	  
<p>Temperature compensation of process medium</p>  <p>Enter reference temperature</p> 	<p><b>With linear compensation only:</b></p> <p>Step 1: Enter temperature compensation of the process medium.</p> <p>Step 2: Enter reference temperature. Enter value using <math>\blacktriangle</math> <math>\blacktriangledown</math> <math>\blacktriangleleft</math> <math>\blacktriangleright</math> keys. Press <b>enter</b> to confirm.</p> <p>Permissible range 0 ... 199.9 °C</p>	<p>00.00...19.99 %/K</p>

# Configuration

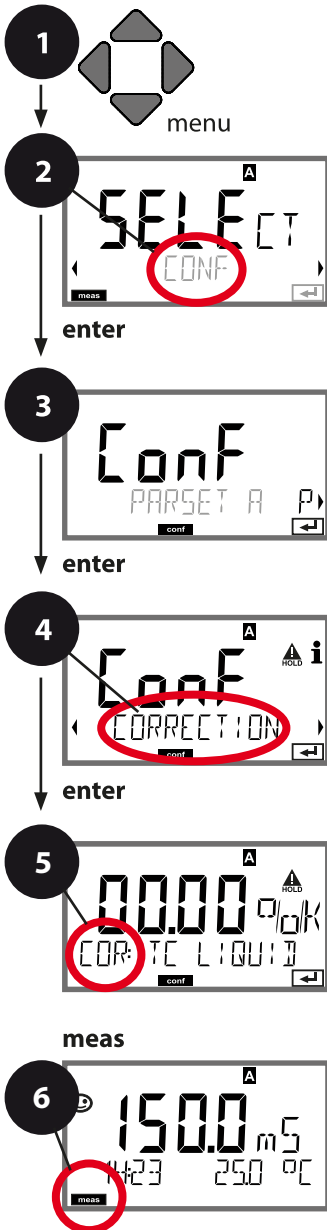

## Temperature Compensation

### Current input for temp measurement.

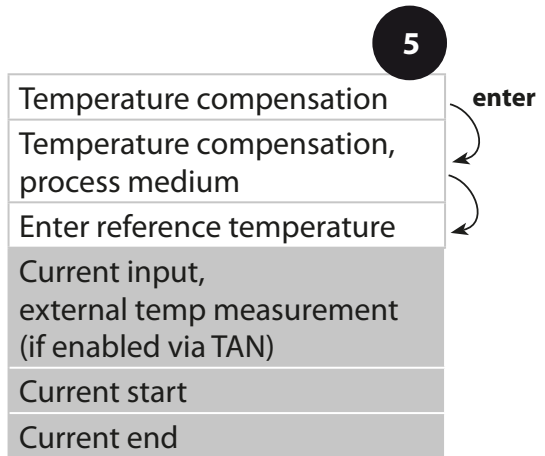

- 1) Press **menu** key.
- 2) Select **CONF** using ◀ ▶ keys, press **enter**.
- 3) Select parameter set using ◀ ▶, press **enter**.
- 4) Select **CORRECTION** menu using ◀ ▶ keys, press **enter**.
- 5) All items of this menu group are indicated by the "COR:" code.  
Press **enter** to select menu, edit using arrow keys (see next page). Confirm (and proceed) using **enter**.
- 6) Exit: Press **meas** key until the [meas] mode indicator is displayed.

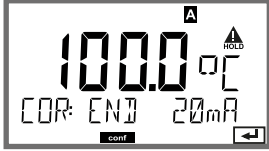

Menu item	Action	Choices
With external temp measurement (current input enabled / TAN):		
Current range	<p>Select desired range using <math>\blacktriangle</math> <math>\blacktriangledown</math> keys.</p> <p>Press <b>enter</b> to confirm.</p>	<b>4-20 mA</b> / 0-20 mA
		
Current start	<p>Modify digit using <math>\blacktriangle</math> <math>\blacktriangledown</math> keys, select next digit using <math>\blacktriangleleft</math> <math>\blacktriangleright</math> keys.</p> <p>Press <b>enter</b> to confirm.</p>	Input range: -50...250 °C / -58...482 °F
		
Current end	<p>Enter value using <math>\blacktriangle</math> <math>\blacktriangledown</math> <math>\blacktriangleleft</math> <math>\blacktriangleright</math> keys.</p> <p>Press <b>enter</b> to confirm.</p>	Input range: -50...250 °C / -58...482 °F
		

# Configuration

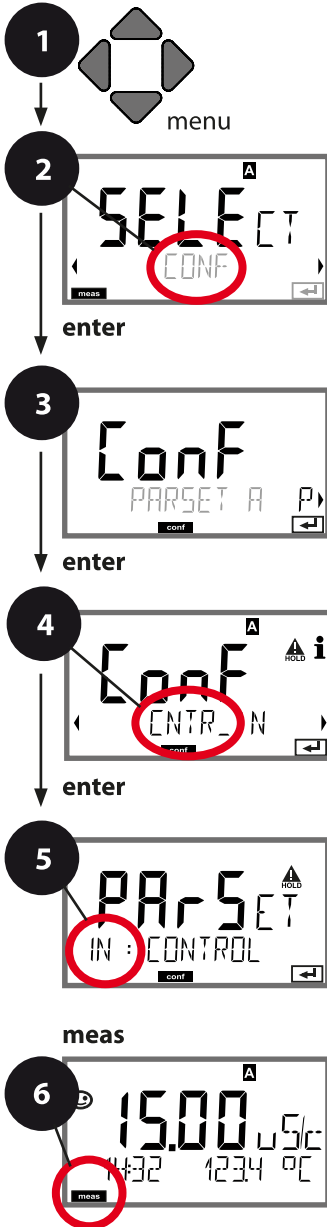

## CONTROL Input (TAN SW-A005)

### Parameter set selection via external signal or flow measurement

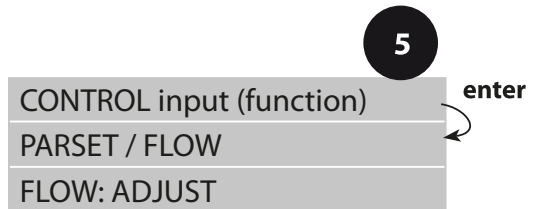

- 1) Press **menu** key.
- 2) Select **CONF** using ◀ ▶ keys, press **enter**.
- 3) Select parameter set using ◀ ▶, press **enter**.
- 4) Select **CNTR\_IN** menu using ◀ ▶ keys, press **enter**.
- 5) All items of this menu group are indicated by the "IN:" code.  
Press **enter** to select menu, edit using arrow keys (see next page). Confirm (and proceed) using **enter**.
- 6) Exit: Press **meas** key until the [meas] mode indicator is displayed.



Menu item	Action	Choices
Select function of CONTROL input  	Select using ▲ ▼ keys. Press <b>enter</b> to confirm.	<b>PARSET</b> (selecting parameter set A/B via signal at CONTROL input)
		Flow (for connecting a pulse-output flow meter)
Adjust to flow meter:  	<b>With "Flow" selected,</b> you must adjust the device to the flow meter used. Enter value using arrow keys. Press <b>enter</b> to confirm.	<b>12000 pulses/liter</b>

In the alarm menu you can configure flow monitoring. When you have set CONTROL to FLOW, you can specify 2 additional limit values for maximum and minimum flow.

If the measured value lies outside this range, an alarm message and a 22-mA error signal (if configured) will be generated.

### Display

Flow measurement in measuring mode



### Display

Flow measurement (sensor monitor)



# Configuration

## Alarm Settings

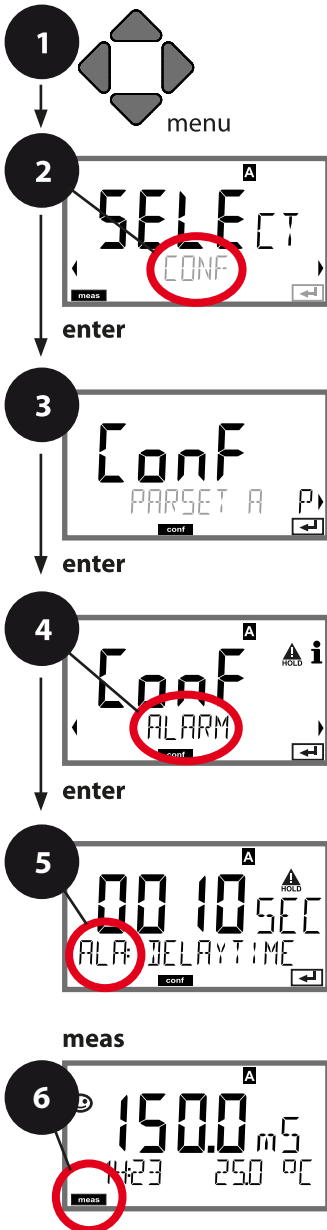

Delay. Sensocheck. Tempcheck.



- 1) Press **menu** key.
- 2) Select **CONF** using ◀ ▶ keys, press **enter**.
- 3) Select parameter set using ◀ ▶, press **enter**.
- 4) Select **ALARM** menu using ◀ ▶ keys, press **enter**.
- 5) All items of this menu group are indicated by the "ALA:" code.  
Press **enter** to select menu, edit using arrow keys (see next page). Confirm (and proceed) using **enter**.
- 6) Exit: Press **meas** key until the [meas] mode indicator is displayed.

Delay	5
Sensocheck	enter
Tempcheck	
CONTROL input	
For flow monitoring: Max. flow alarm	
For flow monitoring: Min. flow alarm	

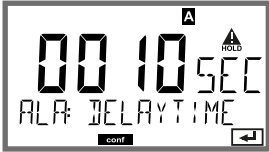

Menu item	Action	Choices
Delay 	Enter value using ▲ ▼ ◀ ▶ keys. Press <b>enter</b> to confirm.	0...600 SEC <b>(010 SEC)</b>
Sensocheck 	Select Sensocheck (continuous monitoring of sensor). Select ON or OFF using ▲ ▼ keys. Press <b>enter</b> to confirm (At the same time, Sensoface is activated. With OFF, Sensoface is also switched off.)	<b>ON/OFF</b>
Tempcheck (see page 48)	To monitor the tempera- ture probe with TC OFF selected: Select Tempcheck ON using ▲ ▼ keys. Press <b>enter</b> to confirm. Now, the temperature probe will be monitored.	<b>ON/OFF</b>

Error messages can be signaled by a 22 mA output current (see Error Messages and Configuration of Output 1/Output 2). **The alarm delay time** delays the color change of the display backlighting to red and the 22 mA signal (if configured).

# Configuration

## Alarm Settings

### CONTROL input (TAN SW-A005)

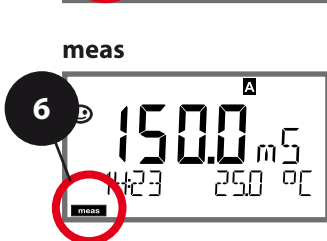
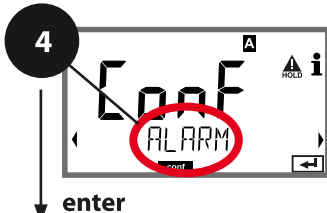
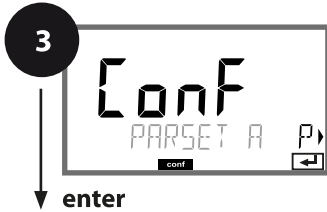
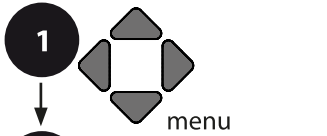

- 1) Press **menu** key.
- 2) Select **CONF** using ◀ ▶ keys, press **enter**.
- 3) Select parameter set using ◀ ▶, press **enter**.
- 4) Select **ALARM** menu using ◀ ▶ keys, press **enter**.
- 5) All items of this menu group are indicated by the "ALA:" code.  
Press **enter** to select menu, edit using arrow keys (see next page). Confirm (and proceed) using **enter**.
- 6) Exit: Press **meas** key until the [meas] mode indicator is displayed.

5

Delay	enter
Sensocheck	
Tempcheck	
CONTROL input	
For flow monitoring: Max. flow alarm	
For flow monitoring: Min. flow alarm	

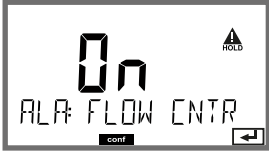
Menu item	Action	Choices
CONTROL input 	The <b>CONTROL input</b> can generate an alarm when assigned to FLOW (flow monitoring) in the CONF menu: <b>FLOW CNTR</b> <b>Flow measurement:</b> allows monitoring the minimum and maximum flow (pulse counter)	<b>ON/OFF</b>  (FLOW MIN, FLOW MAX.)
Alarm Minimum flow <b>FLOW MIN</b>	Specify value	Default: 05.00 liters/h
Alarm Maximum flow <b>FLOW MIN</b>	Specify value	Default: 25.00 liters/h

# Configuration

## Time and Date

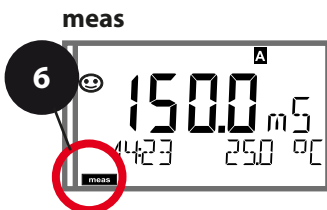
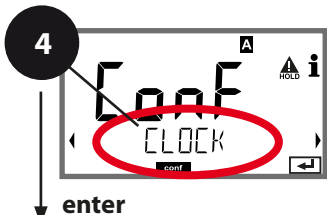
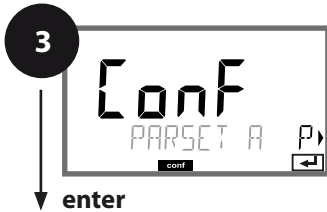
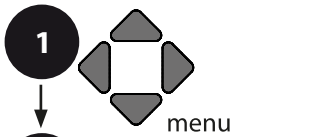

- 1) Press **menu** key.
- 2) Select **CONF** using ◀ ▶, press **enter**.
- 3) Select parameter set A using ◀ ▶ keys, press **enter**.
- 4) Select **CLOCK** using ◀ ▶ keys, press **enter**.
- 5) All items of this menu group are indicated by the "CLK:" code.  
Press **enter** to select menu, edit using arrow keys (see next page). Confirm (and proceed) by pressing **enter**.
- 6) Exit: Press **meas** key until the [meas] mode indicator is displayed.

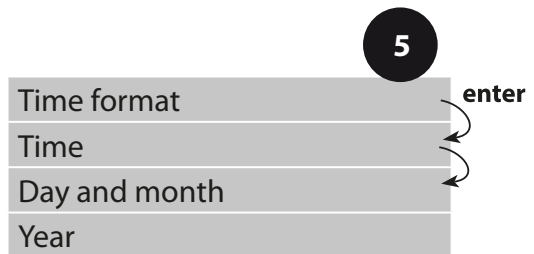

## Time and Date

Control of the calibration and cleaning cycles is based on the time and date of the integrated real-time clock.

In measuring mode the time is shown in the lower display. When using digital sensors, the calibration data is written in the sensor head. In addition, the logbook entries (cf Diagnostics) are provided with a time stamp.

**Note:**

There is no automatic switchover from winter to summer time!

Be sure to manually adjust the time!

# Configuration

## Measuring Points (TAG/GROUP) Display Backlighting

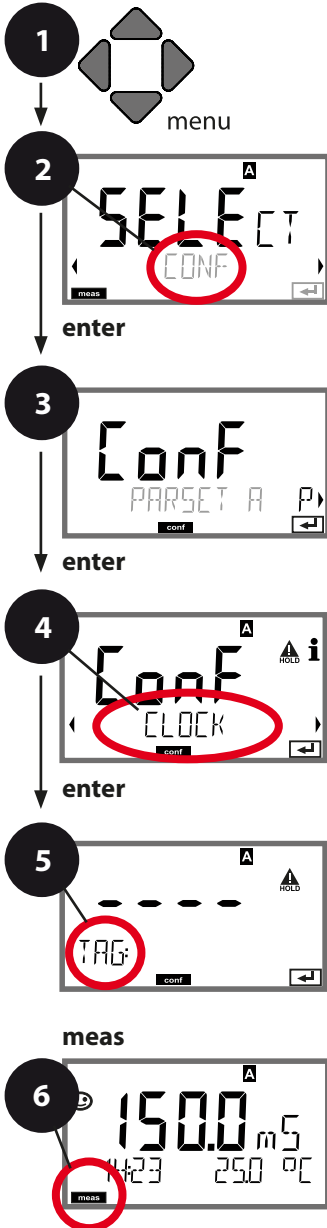

- 1) Press **menu** key.
- 2) Select **CONF** using ◀ ▶, press **enter**.
- 3) Select parameter set A using ◀ ▶ keys, press **enter**.
- 4) Select **TAG** or **DISPLAY** using ◀ ▶ keys, press **enter**.
- 5) All items of this menu group are indicated by the "TAG:" or "DSP" code. Press **enter** to select menu, edit using arrow keys (see next page). Confirm (and proceed) by pressing **enter**.
- 6) Exit: Press **meas** key until the [meas] mode indicator is displayed.

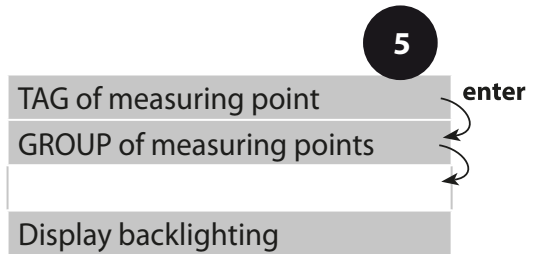

## Sensor Verification (TAG, GROUP)

When Memosens sensors are calibrated in the lab, it is often useful and sometimes even mandatory that these sensors will be operated again at the same measuring points or at a defined group of measuring points. To ensure this, you can save the respective measuring point (TAG) or group of measuring points (GROUP) in the sensor. TAG and GROUP can be specified by the calibration tool or automatically entered by the transmitter. When connecting an MS sensor to the transmitter, it can be checked if the sensor contains the correct TAG or belongs to the correct GROUP. If not, a message will be generated, Sensoface gets "sad", and the display backlighting turns purple (magenta). The "sad" Sensoface icon can also be signaled by a 22 mA error current. Sensor verification can be switched on in the Configuration in two steps as TAG and GROUP if required.

When no measuring point or group of measuring points is saved in the sensor, e.g., when using a new sensor, Stratos enters its own TAG and GROUP. When sensor verification is switched off, Stratos always enters its own measuring point and group. A possibly existing TAG/GROUP will be overwritten.

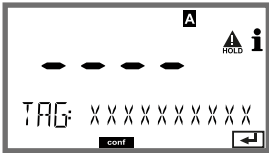
Menu item	Action	Choices
<p>Measuring point (TAG)</p> 	<p>In the lower display line you can enter a designation for the measuring point (TAG) and for a group of measuring points (GROUP) if applicable. Up to 32 digits are possible. Select character using ▲ ▼ keys, select next digit using ◀ ▶ keys. Press <b>enter</b> to confirm. By pressing <b>meas</b> (repeatedly) in the measuring mode you can view the tag number.</p>	<p>A...Z, 0...9, - + &lt; &gt; ? / @</p> <p>The first 10 characters are seen in the display without scrolling.</p>

## Switch Off the Display Backlighting

The display backlighting can be switched off in the DISPLAY menu.

**Note:** If the display backlighting is off, color signaling of error events is not possible.

# Digital Sensors

---

## Operation

Stratos Pro can be operated with digital Memosens sensors. Remove the analog measuring module before connecting a Memosens sensor.

The sensor type is selected during **Configuration**.

The device only switches to measuring mode when the connected sensor corresponds to the type configured (Sensoface is friendly).

The Memosens logo appears on the screen.

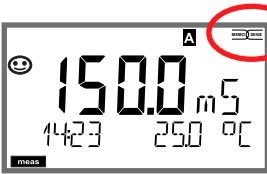

Otherwise, an error message is released. The **info** icon is displayed. You can display the error text in the bottom line using the ◀ ▶ keys. Sensoface is sad (see table of error messages and Sensoface in the Appendix):

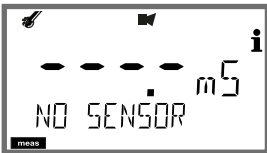

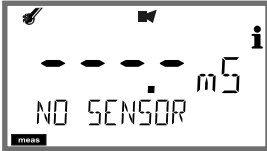
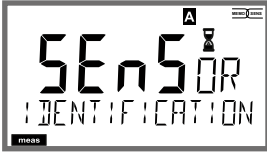
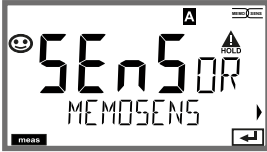
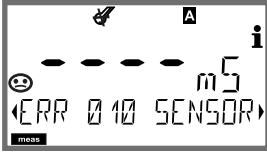

## Connecting a Digital Sensor

Step	Action/Display	Remark
Connect sensor		Before a digital sensor is connected, the error message "No sensor" is displayed.
Wait until the sensor data are displayed.		The hourglass in the display blinks.
Check sensor data	 <p>View sensor information using ◀ ▶ keys, press <b>enter</b> to confirm.</p>	Display color changes to <b>green</b> .  Sensoface is friendly when the sensor data are okay.
Go to measuring mode	Press <b>meas</b> , <b>info</b> or <b>enter</b>	After 60 sec the device automatically returns to measuring mode (time-out).
<b>Possible error messages</b>		
Sensor defective. Replace sensor		When this error message appears, the sensor cannot be used. Sensoface is sad.

## Replacing a Sensor

A digital sensor should only be replaced during HOLD mode to prevent unintended reactions of the outputs or contacts. When you first want to calibrate the new sensor, it can also be replaced in calibration mode.

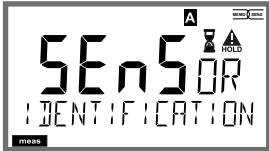
Step	Action/Display	Remark
Select HOLD mode	Press <b>menu</b> key to call the selection menu, select HOLD using the ◀ ▶ keys, press <b>enter</b> to confirm.	Now the device is in HOLD mode. The HOLD mode can also be activated externally via the HOLD input. During HOLD the output current is frozen at its last value or set to a fixed value.
Disconnect and remove old sensor		
Install and connect new sensor.		Temporary messages which are activated during the replacement are indicated but not output to the alarm contact and not entered in the log-book.
Wait until the sensor data are displayed.		

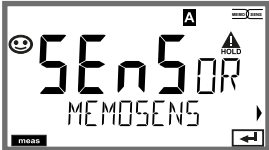
Step	Action/Display	Remark
Check sensor data	 <p>View sensor information using ◀ ▶ keys, press <b>enter</b> to confirm.</p>	You can view the sensor type, serial number, and last calibration date.
Check measured values		
Exit HOLD	Hit <b>meas</b> key: Return to selection menu. Hold <b>meas</b> key depressed: Device switches to measuring mode	The sensor replacement is entered in the extended logbook (TAN SW-A003).

---

# Calibration

---

## Note:

- All calibration procedures must be performed by trained personnel. Incorrectly set parameters may go unnoticed but will alter measurement properties.

Calibration can be performed by:

- Determining the cell constant with a known calibration solution
- Input of cell constant (e.g., for ultrapure-water sensors)
- Entering an installation factor<sup>1)</sup>
- Sampling (product calibration)
- Temperature probe adjustment

## Selecting a Calibration Mode

Calibration adapts the device to the individual sensor characteristics. Access to calibration can be protected with a passcode (SERVICE menu).

In the calibration menu, first select the calibration mode:

CAL_SOL	Calibration with calibration solution, multi-point calibration
CAL_CELL	Calibration by entry of cell constant
CAL_INSTALL	Calibration by entry of installation factor <sup>1)</sup>
P_CAL	Product calibration (calibration by sampling)
CAL_RTD	Temperature probe adjustment

1) The menu is displayed only when a corresponding Memosens sensor is connected.

# Calibration with Calibration Solution

Input of temperature-corrected value of calibration solution with simultaneous display of cell constant.



## Multi-Point Calibration<sup>1)</sup>

For greater measurement accuracy in the range, e.g., near the zero point, up to three calibration points can be used (for configuration, see p. 56). This allows up to three cell constants and two offsets to be determined.





The determined values are displayed in the CALDATA diagnostics menu (see p. 103).

### Notes:

- Known calibration solutions with their corresponding temperature-corrected conductivity values are used for calibration.
- The temperature must be stably maintained during the calibration process.

Display	Action	Remark
	Select Calibration. Press <b>enter</b> to proceed. Select CAL_SOL calibration method. Press <b>enter</b> to proceed.	
	Ready for calibration. Hourglass blinks.	Display (3 sec) The device is now in HOLD mode.
	Press <b>enter</b> to start calibration of the first calibration point.	

# Calibration with Calibration Solution

Display	Action	Remark
	<p>Immerse the sensor in the first calibration solution. Enter the temperature-corrected value of the calibration solution using the arrow keys (see tables, p. 121). Press <b>enter</b> to confirm.</p>	<p>Lower line: Display of currently measured values for conductivity and temperature</p>
	<p>Repeat the process for additional calibration solutions depending on the number of configured calibration points. Rinse the sensor with ultrapure water after each calibration step.</p>	
	<p>After the last calibration step, install the sensor and check if the measurement is OK. MEAS ends the calibration, REPEAT allows for repetition.</p>	<p>Measurement display in the set process variable (here: mS/cm). The device is still in HOLD mode.</p>
		





Outputs remain in HOLD mode for a short time after ending the calibration. After displaying GOOD BYE, the device automatically goes into measuring mode.

Display of conductivity and temperature, Sensoface is active.

# Calibration by Entry of Cell Constant

The value for a sensor's cell constant can be directly entered. The value must be known, e.g., determined beforehand in the laboratory. At the same time, the chosen process variable and temperature are displayed.

**Note:** When selecting CONF > SENSOR > CAL-POINTS: -02/-03- the menu is not displayed.





Display	Action	Remark
	Select Calibration. Press <b>enter</b> to proceed. Select CAL_CELL calibration method. Press <b>enter</b> to proceed.	
	Ready for calibration. Hourglass blinks.	Display (3 sec) The device is now in HOLD mode.
	Enter the cell constant. Press <b>enter</b> to proceed.	At the same time, the chosen process variable and temperature are displayed.
	The device displays the calculated cell constant (at 25°C). Sensoface is active. Press <b>enter</b> to proceed.	
	<b>Use the arrow keys to select:</b> • MEAS (end) • REPEAT Press <b>enter</b> to proceed.	End: HOLD is deactivated after a short time.



# Calibration by Entry of Installation Factor

When using a corresponding Memosens sensor in a tight space, the installation factor is entered. The installation factor is stored in the Memosens sensor.

**Note:** The menu is displayed only when a corresponding Memosens sensor is connected.

Display	Action	Remark
	<p>Select Calibration. Press <b>enter</b> to proceed. Select CAL_INSTALL calibration method. Press <b>enter</b> to proceed.</p>	
	<p>Ready for calibration. Hourglass blinks.</p>	<p>Display (3 sec) The device is now in HOLD mode.</p>
	<p>Enter the installation factor. Press <b>enter</b> to proceed.</p>	<p>At the same time, the chosen process variable and temperature are displayed.</p>
	<p><b>Use the arrow keys to select:</b></p> <ul style="list-style-type: none"> <li>• MEAS (end)</li> <li>• REPEAT</li> </ul> <p>Press <b>enter</b> to proceed.</p>	<p>End: HOLD is deactivated after a short time.</p>

# Product Calibration



Calibration by sampling – for product calibration, the uncompensated conductivity ( $\mu\text{S}/\text{cm}$ ,  $\text{mS}/\text{cm}$ ,  $\text{S}/\text{m}$ ) is used.







During product calibration the sensor remains in the process medium. The measurement process is only interrupted briefly.

## Procedure:





- 1) The sample is measured in the lab or directly on the site using a portable meter. To ensure an exact calibration, the sample temperature should correspond to the measured process temperature.  
During sampling the device saves the currently measured value and then returns to measuring mode. The “calibration” mode indicator then blinks.
- 2) In the second step, enter the measured sample value in the device.  
From the difference between the stored measured value and entered sample value, the device calculates the new cell constant.  
If the sample is invalid, the value stored during sampling can be used. This saves the old calibration values. Subsequently, a new product calibration can be started.



**Note:** When selecting CONF > SENSOR > CAL-POINTS: -02-/-03- the menu is not displayed.

Display	Action	Remark
	Select Calibration. Press <b>enter</b> to proceed. Select P_CAL calibration method. Press <b>enter</b> to proceed.	
	Ready for calibration. Hourglass blinks.	Display (3 sec) The device is now in HOLD mode.

Display	Action	Remark
	Take sample and save value. Press <b>enter</b> to proceed.	Now the sample can be measured in the laboratory.
	The device returns to measuring mode.	The blinking CAL mode indicator shows that product calibration has not been terminated.
	<b>Product calibration step 2:</b> When the sample value has been determined, open product calibration once again.	Display (3 sec) The device is now in HOLD mode.
	The stored value is displayed (blinking) and can be overwritten with the lab value. Press <b>enter</b> to proceed.	
	Display of new cell constant (based on 25 °C). Sensoface is active. To end calibration: Select MEAS, then <b>enter</b>	To repeat calibration: Select REPEAT, then <b>enter</b>
	After calibration is ended, the device switches to measuring mode.	Outputs remain in HOLD mode for a short time after ending the calibration.

# Temp Probe Adjustment

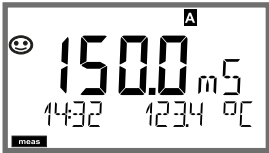
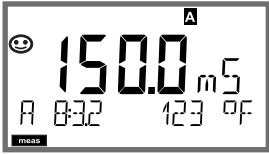
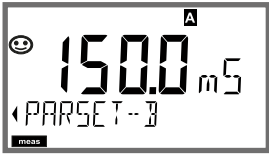
Display	Action	Remark
	<p>Select Calibration. Press <b>enter</b> to proceed. Select CAL_RTD calibration method. Press <b>enter</b> to proceed.</p>	<p>Wrong settings change the mea- surement proper- ties!</p>
	<p>Measure the tempera- ture of the process me- dium using an external thermometer.</p>	<p>Display (3 sec) The device is now in HOLD mode.</p>
	<p>Enter the measured temperature value. Maximum difference: 10 K. Press <b>enter</b> to proceed.</p>	<p>Display of actual temperature (un- compensated) in the lower display.</p>
	<p>The corrected tempera- ture value is displayed. Sensoface is active. To end calibration: Select MEAS, then <b>enter</b> To repeat calibration: Select REPEAT, then <b>enter</b></p>	<p>Outputs remain in HOLD mode for a short time after end- ing the calibration.</p>
	<p>After calibration is end- ed, the device switches to measuring mode.</p>	

Display	Remark
	<p>From the configuration or calibration menus, you can switch the device to measuring mode by pressing the <b>meas</b> key.</p> <p>In the measuring mode the upper display line shows the configured process variable (Cond or temperature), the lower display line shows the time and the second configured process variable (Cond or temperature). The [meas] mode indicator lights and the active parameter set (A/B) is indicated. A/B is not displayed with parameter set "Fix A".</p>
<p>or AM/PM and °F:</p>	
	
<p>By pressing the <b>meas</b> key you can step through the following displays. When no key has been pressed for 60 sec, the device returns to the standard display.</p>	
	<p>1) Selecting the parameter set (if set to "manual" in the configuration). Select the desired parameter set using the ◀ ▶ arrow keys (PARSET A or PARSET B blinks in the lower display line). Press <b>enter</b> to confirm.</p>
	<p>Further displays (each with <b>meas</b>).</p> <p>2) Display of measuring point ("TAG")            3) Display of time and date            4) Display of output current(s)</p>

# Diagnosics

---

In the Diagnostics mode you can access the following menus without interrupting the measurement:



CALDATA	viewing the calibration data
SENSOR	viewing the sensor data
SELFTEST	starting a device self-test
LOGBOOK	viewing the logbook entries
MONITOR	displaying currently measured values
VERSION	displaying device type, software version, serial number

Access to diagnostics can be protected with a passcode (SERVICE menu).

## Note:

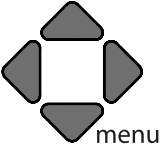
HOLD is not active during Diagnostics mode!

Action	Key	Remark
Activate Diagnostics		Press <b>menu</b> key to call the selection menu. (Display color changes to turquoise.) Select DIAG using ◀ ▶ keys, press <b>enter</b> to confirm.
Select diagnostics option		Use ◀ ▶ keys to select from: CALDATA SENSOR SELFTEST LOGBOOK MONITOR VERSION See next pages for further proceeding.
Exit	<b>meas</b>	Exit by pressing <b>meas</b> .

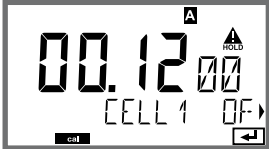
Display	Menu item
	<p><b>Displaying the calibration data</b> Select CALDATA using ◀ ▶, press <b>enter</b> to confirm.</p>
	<p>Use the ◀ ▶ keys to select the desired parameter from the bottom line of the display. The selected parameter is shown in the main display.</p>
	<p>For multi-point calibration, up to 3 cell constants (CELL), 2 offsets (OFFSET) and 2 changeover points (CP) can be displayed using the ◀ ▶ keys.  Press <b>meas</b> to return to measurement.</p>

## Calibration values for multi-point calibration

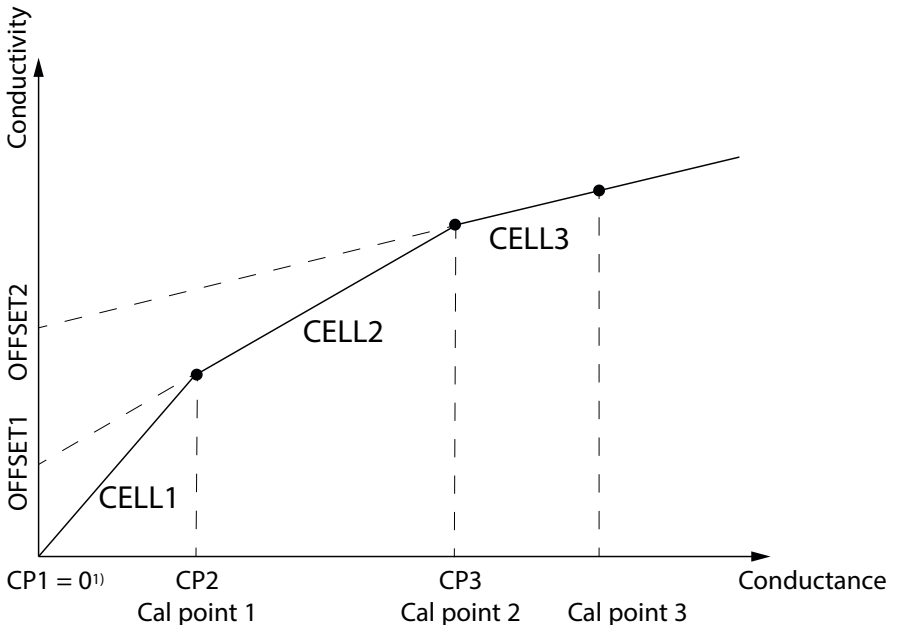

1) Changeover point 1 (CP1) is not displayed.

# Diagnostics

## Display

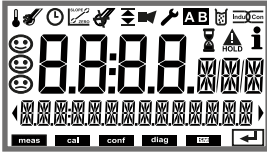

## Menu item

### Device self-test

(To abort, you can press **meas.**)

1) **Display test:** Display of all segments with changing background colors white/green/red. Press **enter** to proceed.







2) **RAM test:** Hourglass blinks, then display of --PASS-- or --FAIL--  
Press **enter** to proceed.

3) **EEPROM test:** Hourglass blinks, then display of --PASS-- or --FAIL--  
Press **enter** to proceed.

4) **FLASH test:** Hourglass blinks, then display of --PASS-- or --FAIL--  
Press **enter** to proceed.

5) **Module test:** Hourglass blinks, then display of --PASS-- or --FAIL--  
Press **enter** or **meas** to return to measuring mode.



Display	Menu item
	<p><b>Displaying the logbook entries (TAN SW-A002)</b>            Select LOGBOOK using ◀ ▶, press <b>enter</b> to confirm.</p> <p>By using the ▲ ▼ keys, you can scroll backwards and forwards through the logbook (entries -00-...-99-), -00- being the last entry.</p>
	<p>If the display is set to date/time, you can search for a particular date using the ▲ ▼ keys.            Press ◀ ▶ to view the corresponding message text.</p>
	<p>If the display is set to the message text, you can search for a particular message using the ▲ ▼ keys.            Press ◀ ▶ to display the date and time.</p> <p>Press <b>meas</b> to return to measurement.</p>
	<p><b>Extended logbook / Audit Trail (TAN SW-A003)</b>            By using the ▲ ▼ keys, you can scroll backwards and forwards through the extended logbook (entries -000-...-199-), -000- being the last entry.  <b>Display: CFR</b>            Audit Trail also records function activations (CAL CONFIG SERVICE), some Sensoface messages, and opening of the enclosure.</p>
	<p><b>Displaying the currently measured values (sensor monitor)</b>            Select MONITOR using ◀ ▶, press <b>enter</b> to confirm.            Use the ◀ ▶ keys to select the desired parameter from the bottom line of the display (R_COND G_COND RTD TEMP I-INPUT (Option) OPERATION TIME CIP SIP).            The selected parameter is shown in the main display.</p>
<p>Display example:</p> 	<p>Press <b>meas</b> to return to measurement.</p>

# Diagnostics



Display	Menu item
 A screenshot of a diagnostic display. The display shows the number '10.2' in large digits, with 'SW' to its right. Below this, it shows 'SERIAL-NO 0073' in smaller digits. At the bottom left, there is a small 'diag' button. At the bottom right, there is a right-pointing arrow button.	<p><b>Version</b></p> <p>Here, you find the data you require for requesting a device-specific Option.</p> <p>Display of <b>device type</b>, <b>software/hardware version</b>, and <b>serial number</b> for all device components.</p> <p>Use the ▲ ▼ keys to switch between software and hardware version. Press <b>enter</b> to proceed to next device component.</p>



In the Service mode you can access the following menus:

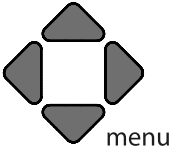

MONITOR	Displaying currently measured values.
OUT1	Testing current output 1.
OUT2	Testing current output 2. (Only if equipped with 2nd current output.)
CODES	Assigning and editing passcodes.
DEFAULT	Resetting the device to factory settings.
OPTION	Enabling options via TAN.

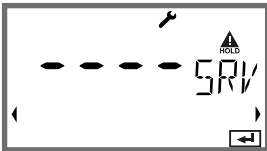
**Note:**

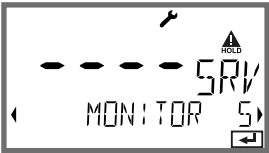
HOLD is active during Service mode!

Action	Key/Display	Remark
Activate Service		Press <b>menu</b> key to call the selection menu. Select SERVICE using ◀ ▶ keys, press <b>enter</b> to confirm.
Passcode		Enter passcode "5555" for service mode using the ▲ ▼ ◀ ▶ keys. Press <b>enter</b> to confirm.
Display		In Service mode the following icons are displayed: <ul style="list-style-type: none"> <li>• [diag] mode indicator</li> <li>• HOLD triangle</li> <li>• Service (wrench)</li> </ul>
Exit	<b>meas</b>	Exit by pressing <b>meas</b> .

Menu item	Remark
 A screenshot of a device's LCD display. The top line shows a dashed line followed by '5.0V' and a 'HOLD' icon. The second line shows 'MONITOR' and a right arrow. There are also left and right arrow icons on the far left and right of the screen.	<p><b>Displaying currently measured values (sensor monitor) with HOLD mode activated:</b> Select MONITOR using ◀ ▶, press <b>enter</b> to confirm. Select variable in the bottom text line using ◀ ▶.</p> <p>The selected parameter is shown in the upper display line. As the device is in HOLD mode, you can perform validations using simulators without influencing the signal outputs.</p> <p>Return to Service menu: Hold <b>meas</b> depressed for longer than 2 sec. Press <b>meas</b> once more to return to measurement.</p>
 A screenshot of a device's LCD display. The top line shows '12.2 mA' and a 'HOLD' icon with an 'i' symbol. The second line shows 'OUT 1' and '12.2 mA'. There are also left and right arrow icons on the far left and right of the screen.	<p><b>Specifying the current at outputs 1 and 2:</b> Select OUT1 or OUT2 using the ◀ ▶ keys, press <b>enter</b> to confirm. Enter a valid current value for the respective output using ▲ ▼ ◀ ▶ keys. Press <b>enter</b> to confirm. For checking purposes, the actual output current is shown in the bottom right corner of the display. End by pressing <b>enter</b> or <b>meas</b>. OUT2: Only if equipped with 2nd current output.</p>

Menu item	Remark
 <p>The LCD display shows '0000' in large digits. To the right, there is a 'PWR' icon with a triangle above it and a 'HOLD' icon with a triangle above it. Below the digits, the words 'DIAG' and 'HOLD' are visible, with a right-pointing arrow next to 'HOLD'.</p>	<p><b>Assigning passcodes:</b>          In the "SERVICE - CODES" menu you can assign passcodes to DIAG, HOLD, CAL, CONF and SERVICE modes (Service preset to 5555).</p> <p><b>When you have lost the Service passcode</b>, you have to request an "Ambulance TAN" from the manufacturer specifying the serial number of your device. To enter the "Ambulance TAN", call the Service function and enter passcode 7321. After correct input of the ambulance TAN the device signals "PASS" for 4 sec and resets the Service passcode to 5555.</p>
 <p>The LCD display shows 'FACTORY SETTING' in large letters. Above it, there are three dashes and a 'NO' option with a right-pointing arrow. There is also a 'HOLD' icon with a triangle above it and an information icon 'i'.</p>	<p><b>Reset to factory settings:</b>          In the "SERVICE - DEFAULT" menu you can reset the device to factory settings.</p> <p><b>NOTICE</b>          After a reset to factory setting the device must be reconfigured completely, including the sensor parameters!</p>
 <p>The LCD display shows '0000' in large digits. To the right, there is a 'TAN' icon with a triangle above it and a 'HOLD' icon with a triangle above it. Below the digits, the text 'OPT: LOGBOOK' is visible, with a right-pointing arrow next to it.</p>	<p><b>Option request:</b>          Communicate the serial number and hardware/software version of your device to the manufacturer. These data can be viewed in the Diagnostics/Version menu.</p> <p>The "transaction number" (TAN) you will then receive is only valid for the device with the corresponding serial number.</p> <p><b>Releasing an option:</b>          Options come with a "transaction number" (TAN). To release the option, enter this TAN and confirm by pressing <b>enter</b>.</p>

# USP Function

---

According to the "USP" directive (U.S.Pharmacopeia), Section 645 "Water Conductivity" the conductivity of pharmaceutical waters can be monitored online. To do so, the conductivity is measured without temperature compensation and is compared with limit values (see table on next page).

The water is usable when the conductivity is below the USP limit. If the conductivity values are higher, further test steps must be performed according to the directive.

## Configuring:

- **SNS** menu group:

































When "USP function" has been selected, the measuring range is fixed to 00.00.....99.99  $\mu\text{S/cm}$ . Temperature compensation is switched off. Temperature is monitored.

If the USP limit is exceeded, a 22 mA signal is output.

## Temperature/Conductivity Table as per USP

Temp (°C)	Cond ( $\mu\text{S/cm}$ )	Temp (°C)	Cond ( $\mu\text{S/cm}$ )
0	0.6	55	2.1
5	0.8	60	2.2
10	0.9	65	2.4
15	1.0	70	2.5
20	1.1	75	2.7
25	1.3	80	2.7
30	1.4	85	2.7
35	1.5	90	2.7
40	1.7	95	2.9
45	1.8	100	3.1
50	1.9		

# Operating States

Operating status	OUT 1	OUT 2	Time out
Measuring			-
DIAG			60 s
CAL_SOL Calibration solution			No
CAL_CELL Cell constant			No
P_CAL Product cal S1			No
P_CAL Product cal S2			No
CAL_RTD Temp adjustment			No
CONF ParSet A			20 min
CONF ParSet B			20 min
SERVICE MONITOR			20 min
SERVICE OUT 1			20 min
SERVICE OUT 2			20 min
SERVICE CODES			20 min
SERVICE DEFAULT			20 min
SERVICE OPTION			20 min
HOLD input			No

Explanation:  as configured (Last/Fix or Last/Off)

 active  manual

# Maintenance and Repair

---

## Maintenance

Stratos Pro does not require maintenance.

If maintenance work (e.g., sensor replacement) has to be performed at the measuring point, you must activate the function check (HOLD) mode on the device as follows:

- Opening the Calibration menu
- Opening the Service menu
- Opening the Configuration menu

## Repair

The Stratos Pro and the measuring modules cannot be repaired by the user. To request a repair, please contact Knick Elektronische Messgeräte GmbH & Co. KG by visiting [www.knick-international.com](http://www.knick-international.com).



# A201B/X: Supply Units and Connection

Recommended Power Supply Units	Order No.
Stratos Pro A201X, Zone 1:	
Repeater power supply, Ex, 90...253 V AC, output 4...20 mA	WG 21 A7
Repeater power supply, Ex, 90...253 V AC, HART, output 4...20 mA	WG 21 A7 Opt. 470
Repeater power supply, Ex, 24 V AC/DC, output 4...20 mA	WG 21 A7 Opt. 336
Repeater power supply, Ex, 24 V AC/DC, HART, output 4...20 mA	WG 21 A7 Opt. 336, 470
Stratos Pro A201B, Zone 2:	
Repeater power supply, non-Ex, 24 V DC, output 4...20 mA	IsoAmp PWR B 10116
Repeater power supply, non-Ex, 24 V DC, HART, output 0/4...20 mA / 0...10 V	IsoAmp PWR A 20100

## Connection to Supply Units

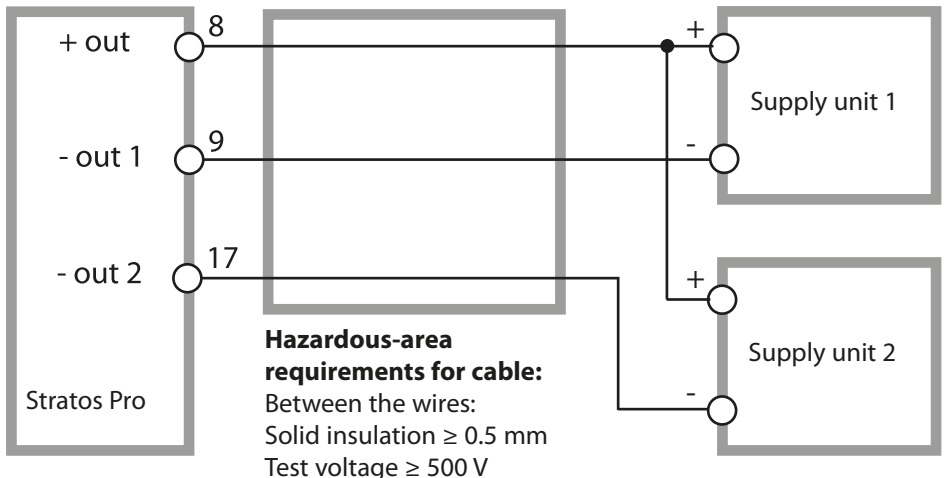

# Product Line and Accessories

## Order Code Stratos Pro A 201

<b>Example</b>	A	2	0	1	X	-	COND	-	1	TAN
2-wire / 4-20 mA	A	2								B,C,E
<b>Communication</b>										
Without (HART retrofittable via TAN)			0							A
<b>Version number</b>										
Version				1						
<b>Approvals</b>										
General Safety					N					
ATEX / IECEx Zone 2					B					
ATEX / IECEx / FM Zone 1 / CI 1 Div 1					X					
<b>Measuring channel</b>										
Memosens pH / Redox	digital						MSPH			G
Memosens Cond	digital						MSCOND			
Memosens Condi	digital						MSCONDI			
Memosens Oxy	digital						MSOXY			
Dual COND (2x2-electrode sensors, analog)					N		CC			
pH / ORP value (ISM digital per TAN)	Measuring module						PH			F, G
Cond, 2-/4-electrode	Measuring module						COND			
Conductivity, electrodeless	Measuring module						CONDI			
Oxygen (ISM digital and traces per TAN)	Measuring module						OXY			D, F
<b>Options</b>										
Without 2nd current output									0	
With 2nd current output									1	
<b>TAN options</b>										
HART							SW-A001			(A)
Logbook							SW-A002			(B)
Extended logbook (Audit Trail)							SW-A003			(C)
Trace oxygen measurement							SW-A004			(D)
Current input + 2 digital inputs							SW-A005			(E)
ISM digital							SW-A006			(F)
Pfudler							SW-A007			(G)
<b>Mounting accessories</b>										
Pipe-mount kit							ZU 0274			
Protective hood							ZU 0737			
Panel-mount kit							ZU 0738			

# Specifications

<b>COND input</b>	Input for 2-/4-electrode sensors and Memosens sensors		
Measuring ranges	2-el. sensors	0.2 $\mu\text{S} \cdot \text{c}$ ... 200 $\text{mS} \cdot \text{c}$	
	4-el. sensors	0.2 $\mu\text{S} \cdot \text{c}$ ... 1000 $\text{mS} \cdot \text{c}$ (conductance limited to 3500 $\text{mS}$ )	
Display ranges	Conductivity	0.000 ... 9.999 $\mu\text{S}/\text{cm}$	
		00.00 ... 99.99 $\mu\text{S}/\text{cm}$	
		000.0 ... 999.9 $\mu\text{S}/\text{cm}$	
		0.000 ... 9.999 $\text{mS}/\text{cm}$	
		00.00 ... 99.99 $\text{mS}/\text{cm}$	
		000.0 ... 999.9 $\text{mS}/\text{cm}$	
		0.000 ... 9.999 $\text{S}/\text{cm}$	
		00.00 ... 99.99 $\text{S}/\text{cm}$	
	Resistivity	00.00 ... 99.99 $\text{M}\Omega \cdot \text{cm}$	
	Concentration	0.00 ... 99.9 %	
	Salinity	0.0 ... 45.0 ‰ (0 ... 35 °C / 32 ... 95 °F)	
	Response time (T90)	Approx. 1 s	
Measurement error <sup>1,2,3)</sup>	< 1 % of measured value + 0.4 $\mu\text{S} \cdot \text{c}$		
<b>Temp compensation *</b>	(OFF)	Without	
	(LIN)	Linear characteristic 00.00 ... 19.99%/K (reference temp user-defined)	
	(NLF)	Natural waters to EN 27888 (reference temp 25 °C / 77 °F)	
	(NACL)	Ultrapure water with NaCl traces (0 ... 120 °C / 32 ... 248 °F), reference temp 25 °C / 77 °F	
	(HCL)	Ultrapure water with HCl traces (0 ... 120 °C / 32 ... 248 °F), reference temp 25 °C / 77 °F	
	(NH3)	Ultrapure water with NH3 traces (0 ... 120 °C / 32 ... 248 °F), reference temp 25 °C / 77 °F	
	(NaOH)	Ultrapure water with NaOH traces (0 ... 120 °C / 32 ... 248 °F), reference temp 25 °C / 77 °F	
<b>Concentration determination</b>	-01- NaCl	0 – 26 wt% (0 °C / 32 °F)	... 0 – 28 wt% (100 °C / 212 °F)
	-02- HCl	0 – 18 wt% (-20 °C / -4 °F)	... 0 – 18 wt% (50 °C / 122 °F)
	-03- NaOH	0 – 13 wt% (0 °C / 32 °F)	... 0 – 24 wt% (100 °C / 212 °F)
	-04- H <sub>2</sub> SO <sub>4</sub>	0 – 26 wt% (-17 °C / 1.4 °F)	... 0 – 37 wt% (110 °C / 230 °F)
	-05- HNO <sub>3</sub>	0 – 30 wt% (-20 °C / -4 °F)	... 0 – 30 wt% (50 °C / 122 °F)

# Specifications

<b>Concentration determination (continued)</b>	-06- H <sub>2</sub> SO <sub>4</sub>	94 – 99 wt% (-17 °C / 1.4 °F)	... 89 – 99 wt% (115 °C / 239 °F)
	-07- HCl	22 – 39 wt% (-20 °C / -4 °F)	... 22 – 39 wt% (50 °C / 122 °F)
	-08- HNO <sub>3</sub>	35 – 96 wt% (-20 °C / -4 °F)	... 35 – 96 wt% (50 °C / 122 °F)
	-09- H <sub>2</sub> SO <sub>4</sub>	28 – 88 wt% (-17 °C / 1.4 °F)	... 39 – 88 wt% (115 °C / 239 °F)
	-10- NaOH	15 – 50 wt% (0 °C / 32 °F)	... 35 – 50 wt% (100 °C / 212 °F)
	-U1-	Specifiable concentration table	
<b>Sensor adjustment</b>	Calibration with calibration solution, multi-point calibration Calibration by entry of cell constant Calibration by entry of an installation factor (with Memosens sensor) Product calibration (sampling) Temperature probe adjustment		
Permissible cell constant	00.0050 ... 19.9999 cm <sup>-1</sup>		
<b>Sensocheck</b>	Polarization detection and monitoring of cable capacitance		
Delay	Approx. 30 s		
<b>Sensoface</b>	Provides information on the condition of the sensor		
<b>Sensor monitor</b>	Direct display of measured values from sensor for resistance/temperature validation		
<b>USP function</b>	Water monitoring in the pharmaceutical industry (USP) with additionally specifiable limit (%)  Output via a relay contact and via HART		
<b>Temperature input<sup>*)</sup></b>	Pt100/Pt1000/NTC 30 kΩ/NTC 8.55 kΩ (Betatherm), Ni 100  3-wire connection, adjustable		
Measuring range	Pt 100/Pt 1000	-50 ... +250 °C / -58 ... +482 °F	
	NTC 30 kΩ	-20 ... +150 °C / -4 ... +302 °F	
	NTC 8.55 kΩ	-10 ... +130 °C / -4 ... +266 °F	
	Ni 100	-50 ... +180 °C / -58 ... +356 °F	
Resolution	0.1 °C / 0.1 °F		
Measurement error <sup>1,2,3)</sup>	< 0.5 K (< 1 K for Pt 100; < 1 K for NTC >100 °C)		

<b>I input (TAN)</b>	Current input 0/4 ... 20 mA / 50 Ω for external temperature signal		
Start/end of scale	Configurable -50 ... 250 °C / -58 ... 482 °F		
Characteristic	Linear		
Measurement error <sup>1,3)</sup>	< 1% current value + 0.1 mA		
<b>HOLD input (TAN)</b>	Galvanically separated (optocoupler)		
Function	Switches device to HOLD mode		
Switching voltage	0 ... 2 V AC/DC	HOLD inactive	
	10 ... 30 V AC/DC	HOLD active	
<b>CONTROL input (TAN)</b>	Galvanically separated (optocoupler)		
Function	Selecting parameter set A/B or flow measurement		
Parameter set A/B	Control input	0 ... 2 V AC/DC	Parameter set A
		10 ... 30 V AC/DC	Parameter set B
FLOW	Pulse input for flow measurement 0 ... 100 pulses/s		
Message	via 22 mA		
Display	00.0 ... 99.9 l/h		
<b>Output 1</b>	Current loop, 4 ... 20 mA, floating, reverse polarity protected HART communication (see further below for specifications)		
Supply voltage	14 ... 30 V		
Process variable *	Conductivity, resistivity, concentration, salinity, or temperature		
Characteristic *	Linear, bilinear, or logarithmic		
Overrange *	22 mA in the case of error messages		
Output filter *	PT <sub>1</sub> filter, time constant 0 ... 120 s		
Measurement error <sup>1)</sup>	< 0.25 % current value + 0.025 mA		
Start/end of scale *	Configurable within selected range		
Bilinear: Vertex X/Y *	Configurable within selected range		

# Specifications

---

## Output 2

For version with 2nd current output only

Current loop, 4 ... 20 mA, floating, reverse polarity protected

Supply voltage

14 ... 30 V

Process variable \*

Conductivity, resistivity, concentration, salinity or temperature

Characteristic \*

Linear, bilinear, or logarithmic

Overrange \*

22 mA in the case of error messages

Output filter \*

PT, filter, time constant 0 ... 120 s

Measurement error <sup>1)</sup>

< 0.25 % of current value + 0.05 mA

Start/end of scale \*

Configurable within selected range

Bilinear: Vertex X/Y \*

Configurable within selected range

## Real-time clock

Different time and date formats selectable

Power reserve

> 5 days

## Display

LC display, 7-segment with icons

Main display

Character height approx. 22 mm, unit symbols approx. 14 mm

Secondary display

Character height approx. 10 mm

Text line

14 characters, 14 segments

Sensoface

3 status indicators (friendly, neutral, sad face)

Mode indicators

meas, cal, conf, diag

Further icons for configuration and messages

Alarm indication

Display blinks, red backlighting

## Keypad

Keys: meas, menu, info, 4 cursor keys, enter

## HART communication (TAN)

HART version 6

Digital communication by FSK modulation of output current 1

Device identification, measured values, status and messages, parameter setting, calibration, records

## FDA 21 CFR Part 11

Access control by editable passcodes

Logbook entry and flag via HART in the case of configuration changes

Message and logbook entry when enclosure is opened

## Diagnostic functions

Calibration data	Calibration date, cell constant
Device self-test	Display test, automatic memory test (RAM, FLASH, EEPROM), module test
Logbook (TAN)	100 events with date and time
Extended logbook (TAN)	Audit Trail: 200 events with date and time

## Service functions

Sensor monitor	Display of direct sensor signals
Current source	Current specifiable for output 1 and 2 (04.00 ... 22.00 mA)
Passcodes	Assigning passcodes for menu access
Factory setting	Resetting all parameters to factory setting
TAN	Enabling optionally available additional functions

<b>Data retention</b>	Parameters, calibration data, logbook > 10 years (EEPROM)
-----------------------	-----------------------------------------------------------

<b>Housing</b>	Molded enclosure, glass fiber reinforced Front unit material: PBT Rear unit material: PC
----------------	------------------------------------------------------------------------------------------------

Mounting	Wall, pipe/post or panel mounting
----------	-----------------------------------

Color	Gray RAL 7001
-------	---------------

Ingress protection	IP66/IP67/TYP 4X outdoor (with pressure compensation) when the device is closed
--------------------	---------------------------------------------------------------------------------

Flammability	UL 94 V-0 for external parts
--------------	------------------------------

Dimensions	148 mm x 148 mm
------------	-----------------

Control panel cutout	138 mm x 138 mm acc. to DIN 43 700
----------------------	------------------------------------

Weight	approx. 1200 kg (1.6 kg incl. accessories and packaging)
--------	----------------------------------------------------------

Cable glands	5 knockouts for M20 x 1.5 cable glands 2 of 5 knockouts for NPT ½" or rigid metallic conduit
--------------	-------------------------------------------------------------------------------------------------

## Terminals

Screw terminals	for single or stranded wires 0.2... 2.5 mm <sup>2</sup>
-----------------	---------------------------------------------------------

Tightening torque	0.5 ... 0.6 Nm
-------------------	----------------

# Specifications

---

## Wiring

Stripping length Max. 7 mm

Temperature resistance > 75 °C / 167 °F

## Rated operating conditions

Climatic class 3K5 according to EN 60721-3-3

Location class C1 according to EN 60654-1

Ambient temperature -20 ... 65 °C / -4 ... 149 °F

Relative humidity 5 ... 95 %

Supply voltage 14 ... 30 V

## Transport and storage

Transport / storage temperature -30 ... 70 °C / -22 ... 158 °F

## EMC

Emitted interference Class A (industrial applications) <sup>4)</sup>

Immunity to interference Industrial applications

\*) User-defined

1) At rated operating conditions

2) ± 1 count

3) Plus sensor error



## Potassium Chloride Solutions

(Conductivity in mS/cm)

Temperature [°C]	Concentration <sup>1</sup>		
	0.01 mol/l	0.1 mol/l	1 mol/l
0	0.776	7.15	65.41
5	0.896	8.22	74.14
10	1.020	9.33	83.19
15	1.147	10.48	92.52
16	1.173	10.72	94.41
17	1.199	10.95	96.31
18	1.225	11.19	98.22
19	1.251	11.43	100.14
20	1.278	11.67	102.07
21	1.305	11.91	104.00
22	1.332	12.15	105.94
23	1.359	12.39	107.89
24	1.386	12.64	109.84
25	1.413	12.88	111.80
26	1.441	13.13	113.77
27	1.468	13.37	115.74
28	1.496	13.62	
29	1.524	13.87	
30	1.552	14.12	
31	1.581	14.37	
32	1.609	14.62	
33	1.638	14.88	
34	1.667	15.13	
35	1.696	15.39	
36		15.64	

1) Data source: K. H. Hellwege (Editor), H. Landolt, R. Börnstein: Zahlenwerte und Funktionen ..., volume 2, part. volume 6

# Calibration Solutions

---

## Sodium Chloride Solutions

(Conductivity in mS/cm)

Temperature	Concentration		
[°C]	0.01 mol/l <sup>1)</sup>	0,1 mol/l <sup>1)</sup>	Saturated <sup>2)</sup>
0	0.631	5.786	134.5
1	0.651	5.965	138.6
2	0.671	6.145	142.7
3	0.692	6.327	146.9
4	0.712	6.510	151.2
5	0.733	6.695	155.5
6	0.754	6.881	159.9
7	0.775	7.068	164.3
8	0.796	7.257	168.8
9	0.818	7.447	173.4
10	0.839	7.638	177.9
11	0.861	7.831	182.6
12	0.883	8.025	187.2
13	0.905	8.221	191.9
14	0.927	8.418	196.7
15	0.950	8.617	201.5
16	0.972	8.816	206.3
17	0.995	9.018	211.2
18	1.018	9.221	216.1
19	1.041	9.425	221.0
20	1.064	9.631	226.0
21	1.087	9.838	231.0
22	1.111	10.047	236.1
23	1.135	10.258	241.1
24	1.159	10.469	246.2
25	1.183	10.683	251.3
26	1.207	10.898	256.5
27	1.232	11.114	261.6
28	1.256	11.332	266.9
29	1.281	11.552	272.1
30	1.306	11.773	277.4
31	1.331	11.995	282.7
32	1.357	12.220	288.0
33	1.382	12.445	293.3
34	1.408	12.673	298.7
35	1.434	12.902	304.1
36	1.460	13.132	309.5

---

1) Data source: Test solutions calculated according to DIN IEC 746-3

2) Data source: K. H. Hellwege (Editor), H. Landolt, R. Börnstein: Zahlenwerte und Funktionen ..., volume 2, part. volume 6

---

# Concentration Measurement

## Ranges

Substance	Concentration ranges		
NaCl	0-26 wt% (0 °C / +32 °F) 0-26 wt% (+100 °C / +212 °F)		
Configuration	<b>-01-</b>		
HCl	0-18 wt% (-20 °C / -4 °F) 0-18 wt% (+50 °C / +122 °F)	22-39 wt% (-20 °C / -4 °F) 22-39 wt% (+50 °C / +122 °F)	
Configuration	<b>-02-</b>	<b>-07-</b>	
NaOH	0-13 wt% (0 °C / +32 °F) 0-24 wt% (+100 °C / +212 °F)	15-50 wt% (0 °C / +32 °F) 35-50 wt% (+100 °C / +212 °F)	
Configuration	<b>-03-</b>	<b>-10-</b>	
H <sub>2</sub> SO <sub>4</sub>	0-26 wt% (-17 °C/-1.4 °F) 0-37 wt% (+110 °C/+230 °F)	28-77 wt% (-17 °C/-1.4 °F) 39-88 wt% (+115 °C/+239 °F)	94-99 wt% (-17 °C/-1.4 °F) 89-99 wt% (+115 °C/+239 °F)
Configuration	<b>-04-</b>	<b>-09-</b>	<b>-06-</b>
HNO <sub>3</sub>	0-30 wt% (-20 °C / -4 °F) 0-30 wt% (+50 °C / +122 °F)	35-96 wt% (-20 °C / -4 °F) 35-96 wt% (+50 °C / +122 °F)	
Configuration	<b>-05-</b>	<b>-08-</b>	

For the solutions listed above, the device can determine the substance concentration from the measured conductivity and temperature values in % by wt. The measurement error is made up of the sum of measurements errors during conductivity and temperature measurement and the accuracy of the concentration curves stored in the device. We recommend to calibrate the device together with the sensor, e.g. directly to concentration using the CAL\_CELL method. For exact temperature measurement, you should perform a temperature probe adjustment. For measuring processes with rapid temperature changes, a separate temperature probe with fast response should be used.

When measuring processes such as dilution or intensification of CIP solutions (Clean-In-Place), it is helpful to switch between the parameter sets for measuring the process medium and for measuring the CIP solution.

For specification of a concentration solution for conductivity measurement, see page 55.

# Concentration Curves

## -01- Sodium chloride solution NaCl

← -01- →

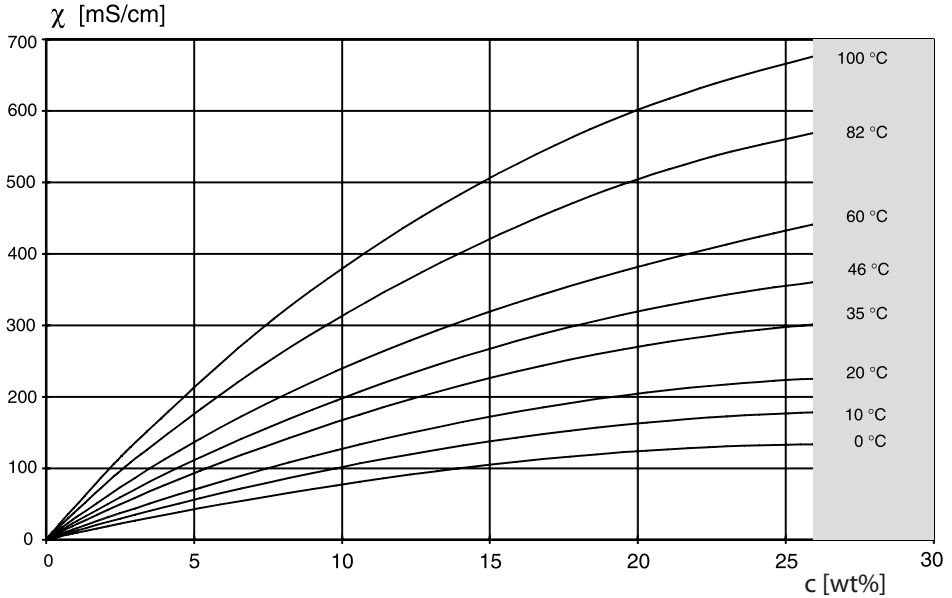

■ Concentration measurement not possible in this range.

Conductivity versus substance concentration and process temperature for sodium chloride solution (NaCl)

## -02- Hydrochloric acid HCl

-07-

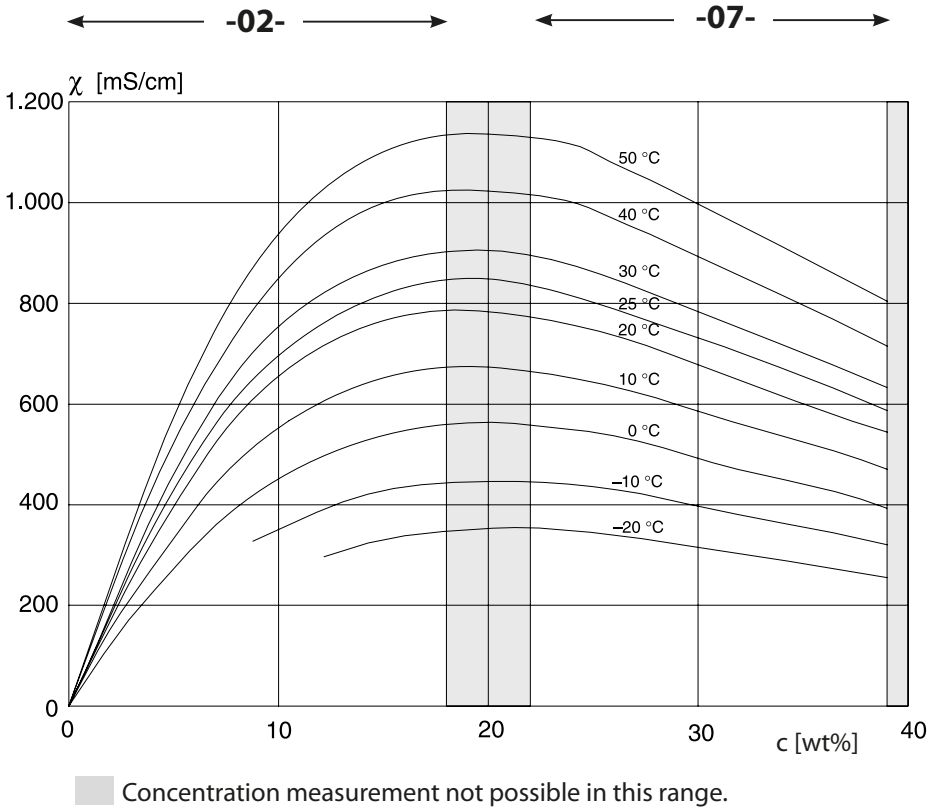

Conductivity versus substance concentration and process temperature for hydrochloric acid (HCl)

Source: Haase/Sauermann/Dücker; Z. phys. Chem. New Edition, Vol. 47 (1965)

# Concentration Curves

## -03- Sodium hydroxide solution NaOH

-10-

← -03- → ← -10- →

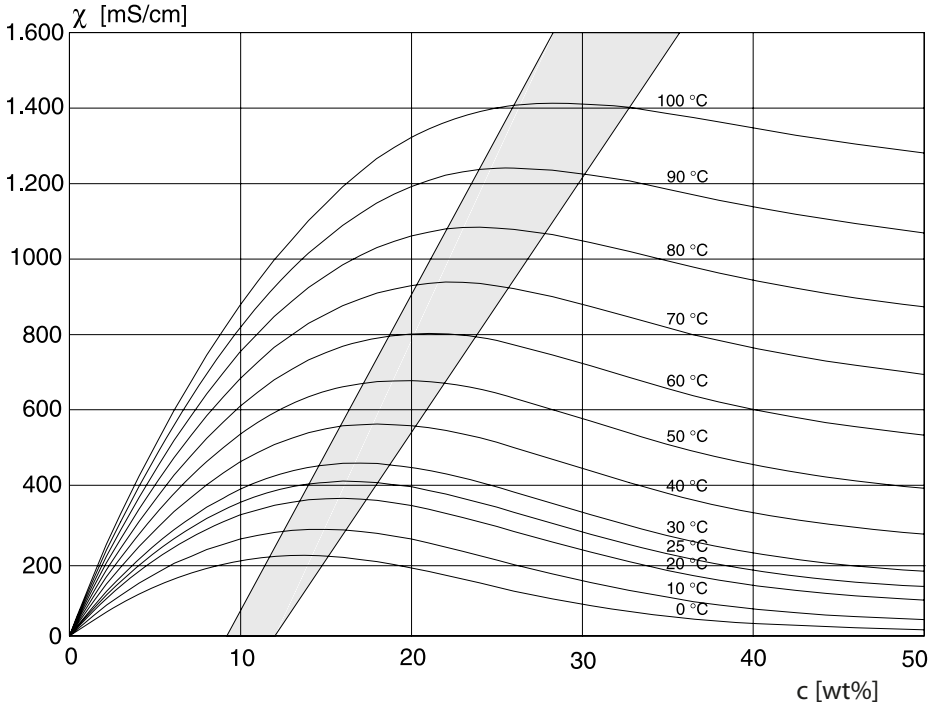

■ Concentration measurement not possible in this range.

Conductivity versus substance concentration and process temperature for sodium hydroxide solution (NaOH)

**-04- Sulfuric acid  $H_2SO_4$**

**-06-**

**-09-**

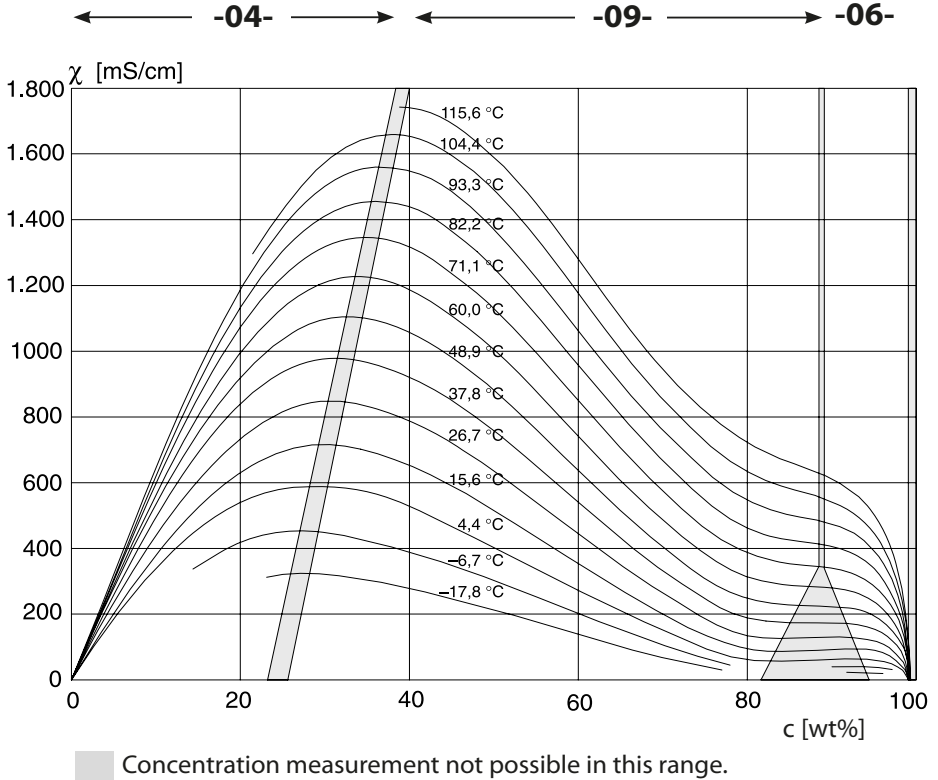

Conductivity versus substance concentration and process temperature for sulfuric acid ( $H_2SO_4$ )

Source: Darling; Journal of Chemical and Engineering Data; Vol.9 No.3, July 1964

# Concentration Curves

-05- Nitric acid  $\text{HNO}_3$

-08-

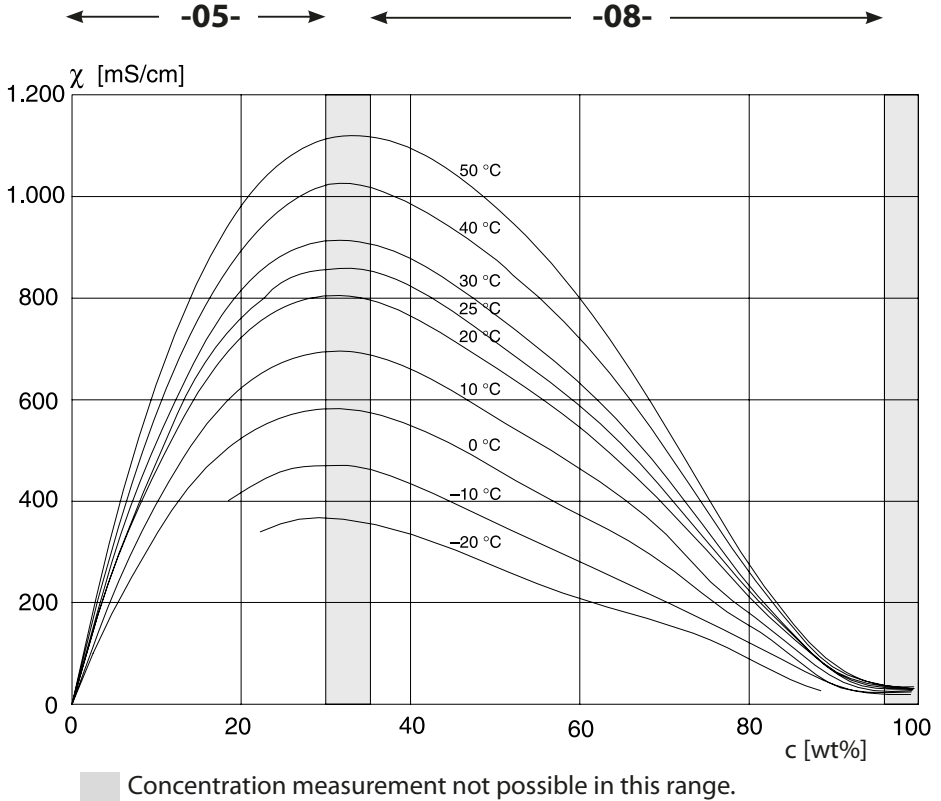

Conductivity versus substance concentration and process temperature for nitric acid ( $\text{HNO}_3$ )

Source: Haase/Sauermann/Dücker; Z. phys. Chem. New Edition, Vol. 47 (1965)



## Alarm condition:

- The display backlighting turns **red**
- The alarm icon  is displayed
- The complete measured-value display blinks
- “**ERR xxx**” is displayed in the lower menu line

Press the [**info**] key to view a short error text:

- The error text appears in the lower menu line
- The main display reads “**InFo**”.

## Parameter errors:

Configuration data such as current range, limit values, etc are checked during the input.

If they are out of range,

- “**ERR xxx**” is displayed for 3 sec,
- the display backlighting flashes red,
- the respective maximum or minimum value is shown,
- input must be repeated.

If a faulty parameter arrives through the interface (HART),

- an error message will be displayed: “**ERR 100...199**”
- the faulty parameter can be localized by pressing the [**info**] key

## Calibration errors:

If errors occur during calibration,

- an error message will be displayed

## Sensoface:

If the Sensoface becomes sad,

- the display backlighting will turn magenta (purple)
- the cause can be seen by pressing the **info** key
- the calibration data can be seen in the Diagnostics menu

# Error Messages

<b>Error</b>	<b>Info text</b> (is displayed in case of fault when the Info key is pressed)	<b>Problem</b> <b>Possible causes</b>
<b>ERR 99</b>	DEVICE FAILURE	<b>Error in factory settings</b> EEPROM or RAM defective This error message only occurs in the case of a total defect. The device must be repaired and recalibrated at the factory.
<b>ERR 98</b>	CONFIGURATION ERROR	<b>Error in configuration or calibration data</b> Memory error in device program Configuration or calibration data defective; completely reconfigure and recalibrate the device.
<b>ERR 97</b>	NO MODULE INSTALLED	<b>No module</b> Please have the module replaced in the factory.
<b>ERR 96</b>	WRONG MODULE	<b>Wrong module</b> Please have the module replaced in the factory.
<b>ERR 95</b>	SYSTEM ERROR	<b>System error</b> Restart required. If error still persists, send in the device for repair.
<b>ERR 01</b>	NO SENSOR	<b>No sensor *</b> The sensor is not recognized: Check connections. Check cables/sensor. Replace as required.
<b>ERR 02</b>	WRONG SENSOR	<b>Wrong sensor *</b> Replace the sensor.
<b>ERR 04</b>	SENSOR FAILURE	<b>Failure in sensor *</b> Replace the sensor.

\*) Memosens sensors

<b>Error</b>	<b>Info text</b> (is displayed in case of fault when the Info key is pressed)	<b>Problem</b> <b>Possible causes</b>
<b>ERR 10</b>	CONDUCTANCE TOO HIGH	<b>Measuring range of conductance exceeded</b> > 3500 mS
<b>ERR 11</b>	CONDUCTIVITY RANGE  CONCENTRATION RANGE  SALINITY RANGE	<b>Display range limits exceeded</b>  Cond > 1999 mS/cm > 99.99 S/m < 1 ohm * cm  Conc > 99,99 %  SAL > 45.0 ‰
<b>ERR 13</b>	TEMPERATURE RANGE	<b>Temperature range limits exceeded</b> Connect the sensor, check the sensor cable and replace if necessary, check the sensor connection, adjust the parameter settings.
<b>ERR 15</b>	SENSOCHECK	<b>Sensocheck</b>
<b>ERR 60</b>	OUTPUT LOAD	<b>Load error</b> Check the current loop, deactivate unused current outputs.
<b>ERR 61</b>	OUTPUT 1 TOO LOW	<b>Output current 1</b> < 3.8 mA
<b>ERR 62</b>	OUTPUT 1 TOO HIGH	<b>Output current 1</b> > 20.5 mA
<b>ERR 63</b>	OUTPUT 2 TOO LOW	<b>Output current 2</b> < 3.8 mA
<b>ERR 64</b>	OUTPUT 2 TOO HIGH	<b>Output current 2</b> > 20.5 mA

# Error Messages

---

<b>Error</b>	<b>Info text</b> (is displayed in case of fault when the Info key is pressed)	<b>Problem</b> <b>Possible causes</b>
<b>ERR 72</b>	FLOW TOO LOW	Flow too low
<b>ERR 73</b>	FLOW TOO HIGH	Flow too high
<b>ERR 100</b>	INVALID SPAN OUT1	<b>Span Out1 configuration error</b> Selected span too small
<b>ERR 101</b>	INVALID SPAN OUT2	<b>Span Out2 configuration error</b> Selected span too small
<b>ERR 105</b>	INVALID SPAN I-INPUT	<b>Configuration error</b> Current input
<b>ERR 108</b>	OUT1 INVALID CORNER X/Y	Bilinear characteristic:
<b>ERR 109</b>	OUT2 INVALID CORNER X/Y	Invalid vertex point

## **Disposal**

Local codes and regulations must be observed when disposing of the product.

## **Returns**

If required, send the product in a clean condition and securely packed to your local contact. See [www.knick.de](http://www.knick.de).

# Sensoface

---

(Sensochek must have been activated during configuration.)



The smiley in the display (Sensoface) alerts to sensor problems (defective sensor, sensor wear, defective cable, maintenance request). The permitted calibration ranges and the conditions for a friendly, neutral or sad Sensoface are summarized in the following table. Additional icons refer to the error cause.

## Sensochek

Continuously monitors the sensor polarization and the sensor cable capacitance. Critical values make the Sensoface “sad” and the corresponding icon blinks:



The Sensochek message is also output as error message Err 15.

The display backlighting turns red, output current 1 is set to 22 mA (when configured correspondingly).





Sensochek can be switched off during configuration (then Sensoface is also disabled).

### **Exception:**

After a calibration a smiley is always displayed for confirmation.

### **Note:**

The worsening of a Sensoface criterion leads to the devaluation of the Sensoface indicator (Smiley becomes “sad”). An improvement of the Sensoface indicator can only take place after calibration or removal of the sensor defect.

Display	Problem	Status
	Sensor defect	 Wrong or defective sensor, significant polarization of sensor, or excessive cable capacitance (see also error message Err 15).
	Temperature	 Temperature outside range for TC, conc, sal

# HART: Typical Applications

(SW-A001)

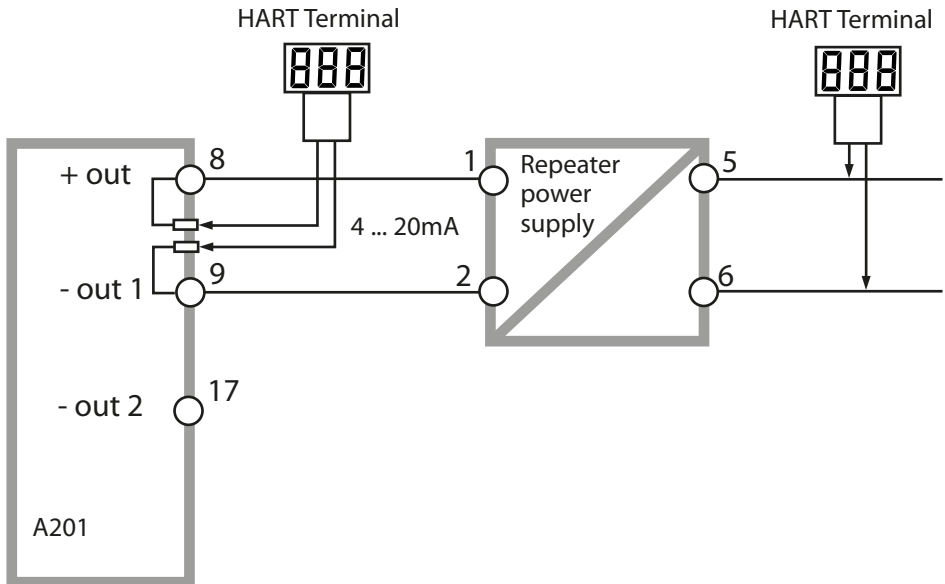
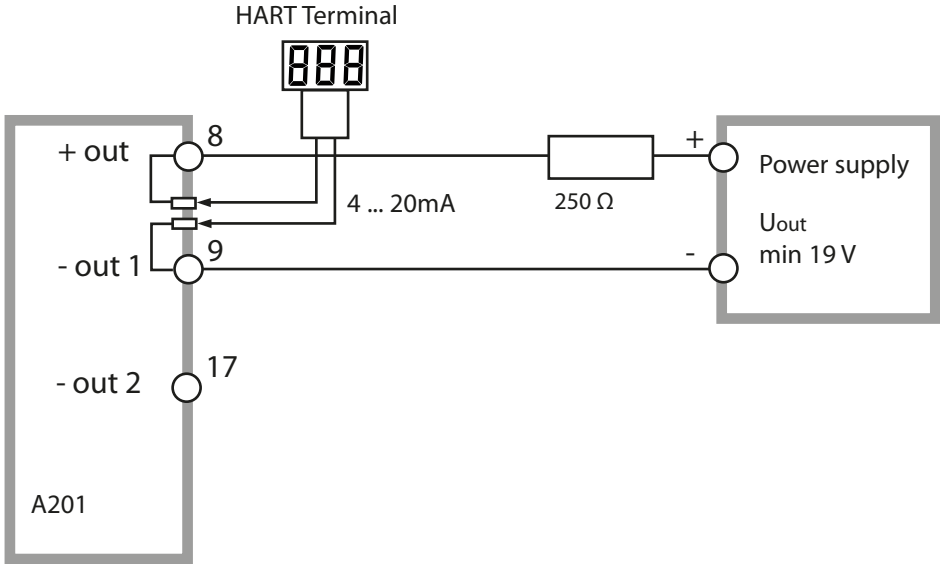



## **Conformity with FDA 21 CFR Part 11**

In their directive “Title 21 Code of Federal Regulations, 21 CFR Part 11, Electronic Records; Electronic Signatures” the American health agency FDA (Food and Drug Administration) regulates the production and processing of electronic documents for pharmaceutical development and production. This results in requirements for measuring devices used for corresponding applications. The following features ensure that the measuring devices of this Series meet the demands of FDA 21 CFR Part 11:

### **Electronic Signature – Passcodes**

Access to the device functions is regulated and limited by individually adjustable codes – “Passcodes” (see SERVICE). This prevents unauthorized modification of device settings or manipulation of the measurement results. Appropriate use of these passcodes makes them suitable as electronic signature.

### **Audit Trail**

Every (manual) change of device settings can be automatically documented. Each change is tagged with a “Configuration Change Flag”, which can be interrogated and documented using HART communication. Altered device settings or parameters can also be retrieved and documented using HART communication.

### **Extended logbook (TAN SW-A003)**

Audit Trail also records function activations (CAL, CONFIG, SERVICE), some Sensoface messages (cal timer, wear, SIP, CIP) and opening of the enclosure.



**Knick**  
**Elektronische Messgeräte**  
**GmbH & Co. KG**

Beuckestraße 22 • 14163 Berlin  
Germany

Phone: +49 30 80191-0

Fax: +49 30 80191-200

info@knick.de

www.knick-international.com

Translation of the original instructions  
Copyright 2024 • Subject to change  
Version: 5 • This document was published on April 22, 2024.  
The latest documents are available for download on our  
website under the corresponding product description.



102821

TA-212.125-KNEN05