

Stratos Multi E461N

Process analysis system

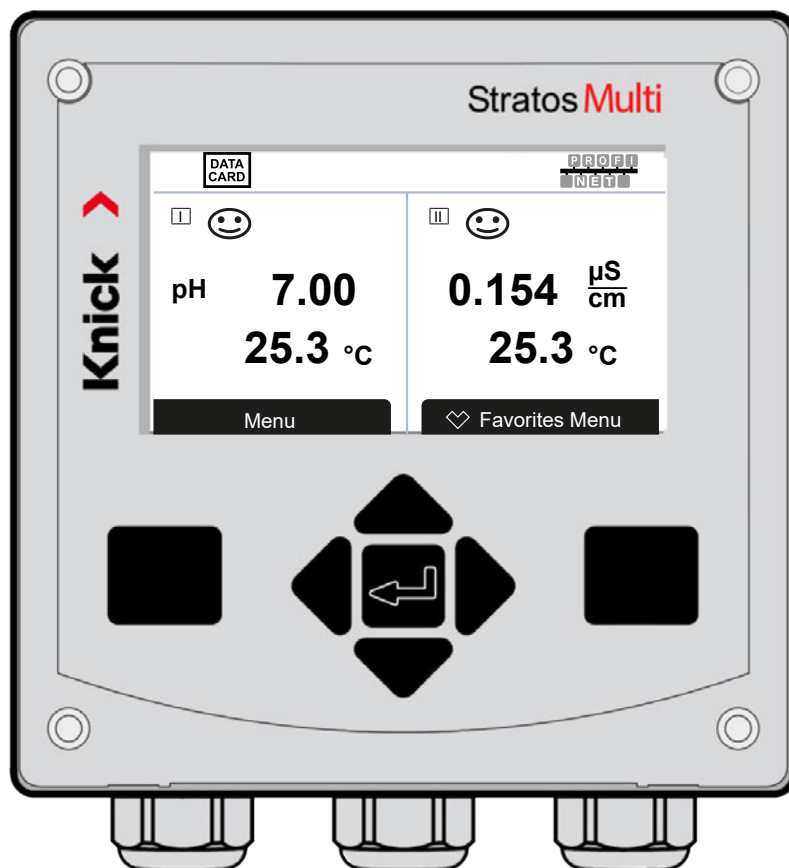

Supplemental Directives

READ AND SAVE THIS DOCUMENT FOR FUTURE REFERENCE. BEFORE ATTEMPTING TO ASSEMBLE, INSTALL, OPERATE OR MAINTAIN THE PRODUCT, PLEASE ENSURE A COMPLETE UNDERSTANDING OF THE INSTRUCTIONS AND RISKS DESCRIBED HEREIN. ALWAYS OBSERVE ALL SAFETY INFORMATION. FAILURE TO COMPLY WITH INSTRUCTIONS IN THIS DOCUMENT COULD RESULT IN SERIOUS INJURY AND/OR PROPERTY DAMAGE. THIS DOCUMENT IS SUBJECT TO CHANGE WITHOUT NOTICE.



These supplemental directives explain how safety information is laid out in this document and what content it covers.

Safety Chapter

This document's safety chapter is designed to give the reader a basic understanding of safety. It illustrates general hazards and gives strategies on how to avoid them.

Warnings

This document uses the following warnings to indicate hazardous situations:

Symbol	Category	Meaning	Remark
	WARNING	Designates a situation that can lead to death or serious (irreversible) injury.	The warnings contain information on how to avoid the hazard.
	CAUTION	Designates a situation that can lead to slight or moderate (reversible) injury.	
<i>None</i>	NOTICE	Designates a situation that can lead to property or environmental damage.	

Symbols Used in this Document

Symbol	Meaning
→	Reference to additional information
✓	Interim or final result in instructions for action
▶	Sequence of figures attached to an instruction for action
①	Item number in a figure
(1)	Item number in text

Table of Contents

1 Safety	9
1.1 Intended Use	9
1.2 Symbols and Markings on the Product.....	9
1.3 Personnel Requirements	10
1.4 Safety Training	10
1.5 Installation and Commissioning.....	10
1.6 Maintenance	11
1.7 Disposal	11
1.8 Residual Risks	11
2 Product	12
2.1 Design and Function.....	12
2.2 Product Range and Options.....	12
2.3 System Overview.....	15
2.4 Package Contents and Product Identification	16
3 Installation	18
3.1 Housing Mounting Options	18
3.2 Enclosure, Mounting Possibilities.....	18
3.3 Dimension Drawings	20
3.3.1 Wall Mounting.....	20
3.3.2 Pipe-Mount Kit ZU0274:.....	22
3.3.3 Protective Hood for Wall and Pipe Mounting ZU0737	23
3.3.4 Panel-Mount Kit ZU0738	24
3.4 Blanking Plugs, Reduction Sealing Inserts, Multiple Sealing Inserts.....	25
3.5 Electrical Installation.....	26
3.5.1 Ethernet Connection.....	28
3.5.2 Installing Active and Passive Current Outputs.....	29
3.5.3 Relay Contacts: Protective Wiring.....	29
3.6 Sensor Connection	31
3.6.1 Connecting a Memosens Sensor/Optical Oxygen Sensor (LDO)	31
3.6.2 Connecting an Analog Sensor/Second Memosens Channel.....	32
3.7 Terminal Assignments of Measuring Modules	33
4 Commissioning	35

5	Operation and Use	36
5.1	Changing the User Interface Language	36
5.2	Keypad and Display	36
5.3	Symbols and Markings on the Display	39
5.4	Menu Structure Overview	41
5.5	Access Control	41
5.6	Operating States	41
5.7	Measurement Display	42
6	Parameter Setting	43
6.1	Operating Levels	43
6.2	Locking a Function	44
6.3	Parameter Setting Menus	45
6.4	System Control	45
6.4.1	Memory Card	46
6.4.2	Transfer Configuration	46
6.4.3	Parameter Sets	47
6.4.4	Function Control	48
6.4.5	Calculation Blocks (TAN Option FW-E020)	48
6.4.6	Time/Date	48
6.4.7	Measuring Point Description	48
6.4.8	Firmware Update (TAN Option FW-E106)	48
6.4.9	Option Activation	49
6.4.10	Logbook	49
6.4.11	Measurement Recorder (TAN Option FW-E103)	49
6.4.12	Buffer Table (TAN Option FW-E002)	50
6.4.13	Concentration Table (TAN Option FW-E009)	50
6.4.14	Restore Factory Settings	50
6.4.15	Passcode Entry	50
6.5	Parameter Setting, General	51
6.5.1	Configuring the Measurement Display	51
6.5.2	Display	56
6.5.3	Measurement Recorder (TAN Option FW-E103)	56
6.6	Inputs and Outputs	57
6.6.1	Current Outputs	57
6.6.2	Relay Contacts	60
6.6.3	Control Inputs	65
6.7	Sensor Selection [I] [II]	66
6.8	pH Process Variable	67
6.8.1	Sensor Data	70
6.8.2	Calibration Presettings	73
6.8.3	Temperature Compensation of Process Medium	74
6.8.4	Delta Function	74
6.8.5	Messages	75
6.9	ORP Process Variable	76
6.9.1	Sensor Data	77
6.9.2	Calibration Presettings	78
6.9.3	Delta Function	78
6.9.4	Messages	79

6.10 Conductivity (Contacting) Process Variable	80
6.10.1 Sensor Data	81
6.10.2 Calibration Presettings	84
6.10.3 Temperature Compensation of Process Medium	84
6.10.4 Concentration (TAN Option FW-E009).....	85
6.10.5 TDS Function.....	85
6.10.6 USP Function.....	85
6.10.7 Messages	86
6.11 Conductivity (Inductive) Process Variable	87
6.11.1 Sensor Data	89
6.11.2 Calibration Presettings	91
6.11.3 Temperature Compensation of Process Medium	92
6.11.4 Concentration (TAN Option FW-E009).....	92
6.11.5 TDS Function.....	92
6.11.6 USP Function.....	93
6.11.7 Messages	94
6.12 Dual Conductivity Measurement	95
6.13 Oxygen Process Variable	96
6.13.1 Sensor Data	99
6.13.2 Calibration Presettings	102
6.13.3 Pressure Correction	102
6.13.4 Salinity Correction.....	103
6.13.5 Messages	103
6.14 PROFINET	104
6.14.1 System Integration	104
6.14.2 Changing the Device	107
6.14.3 Resetting the Device.....	107
6.14.4 Function Blocks (AI, AO, DO)	107
6.14.5 Cyclic Data Transfer	108
6.14.6 Configuring the Measured Values	109
6.14.7 PROFINET Commands	111
6.14.8 Key Lock	115
6.14.9 Diagnostics.....	115
6.14.10 PROFINET Diagnostic Information.....	117
6.14.11 Communication Status	118
6.14.12 I&M Functions	119
6.15 Flow.....	120
7 Calibration/Adjustment	121
7.1 Memosens Calibration/Adjustment.....	122
7.2 pH Process Variable Calibration/Adjustment.....	122
7.2.1 Calibration Methods.....	123
7.2.2 Temperature Compensation during Calibration.....	124
7.2.3 Calibration/Adjustment Methods	124
7.2.4 Calibration Mode: Calimatic	124
7.2.5 Calibration Mode: Manual.....	126
7.2.6 Calibration Mode: Product.....	127
7.2.7 Calibration Mode: Data Entry.....	128
7.2.8 Calibration Mode: ISFET Zero Point	129
7.2.9 Calibration Mode: Temperature	129

7.3	ORP Process Variable Calibration/Adjustment	130
7.3.1	Calibration Mode: ORP Data Entry	130
7.3.2	Calibration Mode: ORP Adjustment.....	131
7.3.3	Calibration Mode: ORP Check.....	132
7.3.4	Calibration Mode: Temperature	132
7.4	Conductivity (Contacting) Process Variable Calibration/Adjustment.....	133
7.4.1	Temperature Compensation during Calibration.....	133
7.4.2	Calibration/Adjustment Methods	134
7.4.3	Calibration Mode: Automatic.....	134
7.4.4	Calibration Mode: Manual.....	135
7.4.5	Calibration Mode: Product.....	136
7.4.6	Calibration Mode: Data Entry.....	138
7.4.7	Calibration Mode: Temperature	138
7.5	Conductivity (Inductive) Process Variable Calibration/Adjustment	139
7.5.1	Temperature Compensation during Calibration.....	139
7.5.2	Calibration/Adjustment Methods	140
7.5.3	Calibration Mode: Automatic.....	140
7.5.4	Calibration Mode: Manual.....	141
7.5.5	Calibration Mode: Product.....	142
7.5.6	Calibration Mode: Zero Point	144
7.5.7	Calibration Mode: Installation Factor	144
7.5.8	Calibration Mode: Data Entry.....	145
7.5.9	Calibration Mode: Temperature	145
7.6	Oxygen Process Variable Calibration/Adjustment	146
7.6.1	Calibration/Adjustment Methods	147
7.6.2	Calibration Mode: In Air	147
7.6.3	Calibration Mode: In Water	148
7.6.4	Calibration Mode: Data Entry.....	149
7.6.5	Calibration Mode: Product.....	149
7.6.6	Calibration Mode: Zero Point	151
7.6.7	Calibration Mode: Temperature	151
8	Diagnostics.....	152
8.1	Favorites Menu.....	152
8.2	Diagnostic Functions	153
8.2.1	Overview of Diagnostic Functions	153
8.2.2	Messages	154
8.2.3	Logbook.....	154
8.2.4	Device Information	155
8.2.5	Device Test	155
8.2.6	Measuring Point Description	156
8.2.7	Channel I/II Diagnostic Functions	156
9	Maintenance Functions.....	158
9.1	Overview of Maintenance Functions	158
9.2	Channel I/II Maintenance Functions	159
9.2.1	Sensor Monitor.....	159
9.2.2	Autoclaving Counter	159
9.2.3	Electrolyte Replacement/Membrane Body Replacement	159
9.2.4	Replacing the Membrane Body/Interior Body.....	160

9.3 Manual Function Check.....	160
9.3.1 Current Source.....	160
9.3.2 Relay Test.....	160
10 Troubleshooting.....	161
10.1 Malfunction States.....	161
10.2 Error Messages.....	161
10.3 Sensocheck and Sensoface.....	178
11 Decommissioning.....	181
11.1 Disposal.....	181
11.2 Returns.....	181
12 Accessories.....	182
12.1 Memory Card.....	182
12.2 ZU1072 RJ45 Socket.....	185
12.3 ZU1073 Adapter Cable RJ45/M12 D-Type.....	186
12.4 ZU1164 Y Cable M12 A Type/D Type.....	187
12.5 ZU1166 Adapter Cable RJ45/M12 A Type.....	188
13 Specifications.....	189
13.1 Power.....	189
13.2 Inputs and Outputs (SELV, PELV).....	189
13.3 Device.....	190
13.4 Rated Operating Conditions.....	191
13.5 Transport and Storage.....	191
13.6 Conformity.....	191
13.7 Communication Interfaces.....	192
13.8 Measuring Functions.....	193
13.8.1 pH.....	193
13.8.2 Conductivity (Contacting).....	195
13.8.3 Conductivity (Inductive).....	196
13.8.4 Conductivity (Dual).....	197
13.8.5 Temperature Compensation (Conductivity).....	198
13.8.6 Concentration Determination, Conductivity (TAN Option FW-E009).....	198
13.8.7 Oxygen.....	199
13.9 Diagnostics and Statistics.....	201
14 Annex.....	202
14.1 Channel II Wiring Examples.....	202
14.1.1 pH Analog Wiring Examples.....	202
14.1.2 ORP Analog Wiring Example.....	208
14.1.3 ISM pH Wiring Example.....	209
14.1.4 Contacting Conductivity Wiring Examples.....	210
14.1.5 Inductive Conductivity Wiring Examples.....	217
14.1.6 Dual Conductivity Wiring Examples.....	219
14.1.7 Oxygen Wiring Examples.....	222

14.2 Buffer Tables.....	225
14.3 Calibration Solutions	233
14.4 TAN Options.....	235
14.4.1 pH Buffer Table: Entry of Individual Buffer Set (FW-E002)	235
14.4.2 Current Characteristic (FW-E006)	237
14.4.3 Concentration Determination (FW-E009).....	237
14.4.4 Pfaudler Sensors (FW-E017).....	242
14.4.5 Calculation Blocks (FW-E020).....	244
14.4.6 Digital ISM Sensors (FW-E053).....	248
14.4.7 Parameter Sets 1-5 (FW-E102).....	249
14.4.8 Measurement Recorder (FW-E103)	250
14.4.9 Firmware Update (FW-E106).....	252
15 PROFINET Technology	253
16 Abbreviations	254
Index.....	255

1 Safety

This document contains important instructions for the use of the product. Always follow all instructions and operate the product with caution. If you have any questions, please contact Knick Elektronische Messgeräte GmbH & Co. KG (sometimes hereafter referred to as "Knick") using the information provided on the back page of this document.

1.1 Intended Use

Stratos Multi E461N is an industrial transmitter for PROFINET communication. It features an RJ45 socket and can therefore be connected in a star topology. With the use of a Y cable, it can be connected in a ring topology. In the field of liquid analysis, the device can measure pH values, ORP, conductivity (contacting or inductive), and oxygen content, both dissolved and in the gaseous phase.

Alongside a permanently installed measuring channel I for Memosens sensors, the modular transmitter has a slot that can be equipped with analog or digital measuring modules (measuring channel II). The transmitter can be extended with device-specific add-on functions called TAN options.

The defined operating conditions must be observed when using this product. → *Specifications, p. 189*

USE CAUTION AT ALL TIMES WHEN INSTALLING, USING, OR OTHERWISE INTERACTING WITH THE PRODUCT. ANY USE OF THE PRODUCT EXCEPT AS SET FORTH HEREIN IS PROHIBITED, AND MAY RESULT IN SERIOUS INJURY OR DEATH, AS WELL AS DAMAGE TO PROPERTY. THE OPERATING COMPANY SHALL BE SOLELY RESPONSIBLE FOR ANY DAMAGES RESULTING FROM OR ARISING OUT OF AN UNINTENDED USE OF THE PRODUCT.

All designations such as "device," "product," "industrial transmitter," or "transducer" refer to the Stratos Multi E461N.

Inputs and Outputs (SELV, PELV)

All inputs and outputs must be connected to SELV/PELV circuits.

Devices Not Intended for Use in Hazardous Locations

Devices identified with an N in their product name must not be used in hazardous locations.

1.2 Symbols and Markings on the Product



CE marking.



Special conditions and danger points! Observe the safety information and instructions on safe use of the product as outlined in the product documentation.



Reminder to read the documentation.



Protection class II

1.3 Personnel Requirements

The operating company shall ensure that any personnel using or otherwise interacting with the product is adequately trained and has been properly instructed.

The operating company shall comply and cause its personnel to comply with all applicable laws, regulations, codes, ordinances and relevant industry qualification standards related to product. Failure to comply with the foregoing shall constitute a violation of operating company's obligations concerning the product, including but not limited to an unintended use as described in this document.

1.4 Safety Training

Upon request, Knick Elektronische Messgeräte GmbH & Co. KG will provide safety briefings and product training during initial commissioning of the product. More information is available from the relevant local contacts.

1.5 Installation and Commissioning

Adhere to all applicable local and national codes and standards for the installation of electrical equipment. Information on installation is provided in the installation guide for the Stratos Multi.

Comply with the points below during installation and commissioning:

- The device must be installed in a stationary location by a licensed electrician in compliance with all applicable local and national codes and standards.
- Take care to avoid notches when stripping the wires.
- The device must be commissioned by a system specialist, and it must be fully configured.

Cable

Only use cables with a suitable temperature resistance.

Cable temperature resistance: > 75 °C (> 167 °F)

To ensure correct data transmission, a suitable PROFINET cable must be connected to the RJ45 socket.
→ *Ethernet Connection, p. 28*

Mains Connection

The device does not have a power switch. An appropriately arranged and accessible disconnecting device for the transmitter must be present in the system installation. The disconnecting device must disconnect all non-grounded, current-carrying wires. The disconnecting device must be labeled in a way that enables the associated transmitter to be identified. The power line may carry dangerous touch voltages. Touch protection must be ensured by proper installation.

Parameter Setting and Adjustment

Incorrect parameter settings or adjustments can result in incorrect outputs. For this reason, Stratos Multi must be commissioned by a specialist, who will also set the parameters and make adjustments.

Relay Contacts

Make sure that the maximum ratings of the relay contacts are not exceeded even during switching. The relay contacts are subject to electrical erosion, which reduces their service life under inductive and capacitive loads.

Degree of Protection

The housing of the device is dust-tight and offers complete protection against contact as well as protection against strong water jets.

- Europe: IP protection IP66/IP67
- USA: TYPE 4X Outdoor (with pressure compensation)

Memory Card

When opening the device, there may be dangerous touch voltages in the terminal compartment. Professional installation guarantees direct contact protection.

The memory card can be replaced during operation. When doing so, maintain sufficient distance from the mains connection cables and do not use tools.

1.6 Maintenance

Stratos Multi does not require maintenance.

If maintenance is required at the measuring point (e.g., sensor replacement), function check mode (HOLD) must be activated in the device's Maintenance menu. This can also be done in the Parameter Settings menu (Operator or Administrator level).

1.7 Disposal

The local codes and regulations must be observed when disposing of the product.

Customers can return their waste electrical and electronic devices.

Details on the return and environmentally friendly disposal of electrical and electronic equipment can be found in the manufacturer's declaration on our website. If you have any queries, suggestions, or questions regarding the recycling of waste electrical and electronic equipment from Knick, please send an email to → support@knick.de

1.8 Residual Risks

The product has been developed and manufactured in accordance with generally accepted safety rules and regulations. The following residual risks remain:

- Ambient conditions with chemically corrosive substances may prevent the system from working properly.
- If access to the operator and administrator levels of the **Parameter Setting** menu is not protected by passcodes, faulty operation may occur.

2 Product

2.1 Design and Function

- The 1- and 2-channel transmitter permits a free combination of the pH/ORP process variables, conductivity (2-/4-electrode sensors, toroidal sensors), and oxygen, and can, for example, simultaneously measure pH values and conductivity.
- The TFT color display provides clear information on operating states and errors during parameter setting or measurement in accordance with NAMUR recommendations.
- The user interface is multi-lingual with full-text menu navigation.

Basic

Communication via PROFINET

1 measuring channel

Second measuring channel via add-on measuring module

Multiparameter: Process variables freely selectable from pH, ORP, oxygen, conductivity (contacting/inductive)

Door contact

2 freely assignable relay contacts

for NAMUR messages (failure, maintenance required, out of specification, function check), setpoint alarm relay, rinse contact, parameter set, USP (for conductivity), Sensoface

1 control input

2 current outputs ¹⁾

Flow measurement

Additional functions (TAN options) can be enabled by entering a transaction number (TAN).

→ *Product Range and Options, p. 12*

2.2 Product Range and Options

Version	Possible combinations
1-channel	1x Memosens sensor
	1x SE740 optical oxygen sensor
	1x analog sensor via measuring module (MK module)
	1x digital ISM sensor via measuring module (MK module) and TAN option FW-E053
2-channel	2x Memosens sensors (1x via MK-MS module)
	1x Memosens sensor (MK-MS module) and 1x SE740 optical oxygen sensor
	1x Memosens sensor and 1x analog sensor via measuring module (MK module)
	1x Memosens sensor and 1x digital ISM sensor via measuring module (MK module) and TAN option FW-E053
	Dual conductivity measurement (MK-CC module)

¹⁾ Not if PROFINET communication is enabled

Product Line

Device (digital basic unit)	Order no.
Stratos E461N	E461N
Measuring module for analog or ISM sensors¹⁾ or 2nd channel Memosens, non-Ex	Order No.
pH value, ORP measurement	MK-PH015N
Oxygen Measurement	MK-OXY046N
Contacting conductivity measurement (process-wetted)	MK-COND025N
Inductive conductivity measurement	MK-CONDI035N
Dual conductivity measurement	MK-CC065N
Memosens multiparameter (for 2-channel version)	MK-MS095N

The following add-on functions (TAN options) can be enabled by entering a TAN:

Add-on function (TAN option)	Order no.
pH buffer table: Entry of individual buffer set	FW-E002
Current characteristic	FW-E006
Concentration determination for use with conductivity sensors	FW-E009
Oxygen measurement in low oxygen concentrations	FW-E015
Pfudler sensors	FW-E017
Calculation blocks	FW-E020
Digital ISM pH/ORP and amperometric ISM oxygen sensors	FW-E053
Parameter sets 1 to 5	FW-E102
Measurement recorder	FW-E103
Logbook	FW-E104
Firmware update	FW-E106
Accessories	Order No.
Pipe-mount kit	ZU0274
Panel-mount kit	ZU0738
Protective hood	ZU0737
M12 socket for sensor connection with Memosens cable/M12 connector	ZU0860
RJ45 socket	ZU1072
Adapter cable RJ45/M12 D-type	ZU1073
Y cable M12 A type/D type	ZU1164
Adapter cable RJ45/M12 A type	ZU1166
Memory cards, non-intrinsically safe	Order no.
Data Card	ZU1080-S-N-D
FW Update Card	ZU1080-S-N-U
FW Repair Card	ZU1080-S-N-R
Custom FW Update Card	ZU1080-S-N-S-*** ²⁾
Custom FW Repair Card	ZU1080-S-N-V-*** ²⁾

See also

→ *Accessories, p. 182*

¹⁾ ISM with TAN option FW-E053

²⁾ *** = device firmware

Operation with Analog Sensors

To enable operation with analog sensors, analog measuring modules are plugged in and must be configured during initial start-up.

Operation with Optical Sensors

The SE740 digital optical sensor for dissolved oxygen can be directly connected to Stratos Multi.

Parameter Sets

Two complete parameter sets (A, B) can be stored in the device. The control element for switching between the parameter sets (optocoupler input OK1, softkey) is selected in the system control.

The currently activated set can be signaled by a relay contact.

Power Supply

The power is provided by an integrated broad-range power supply. → *Specifications, p. 189*

2.3 System Overview

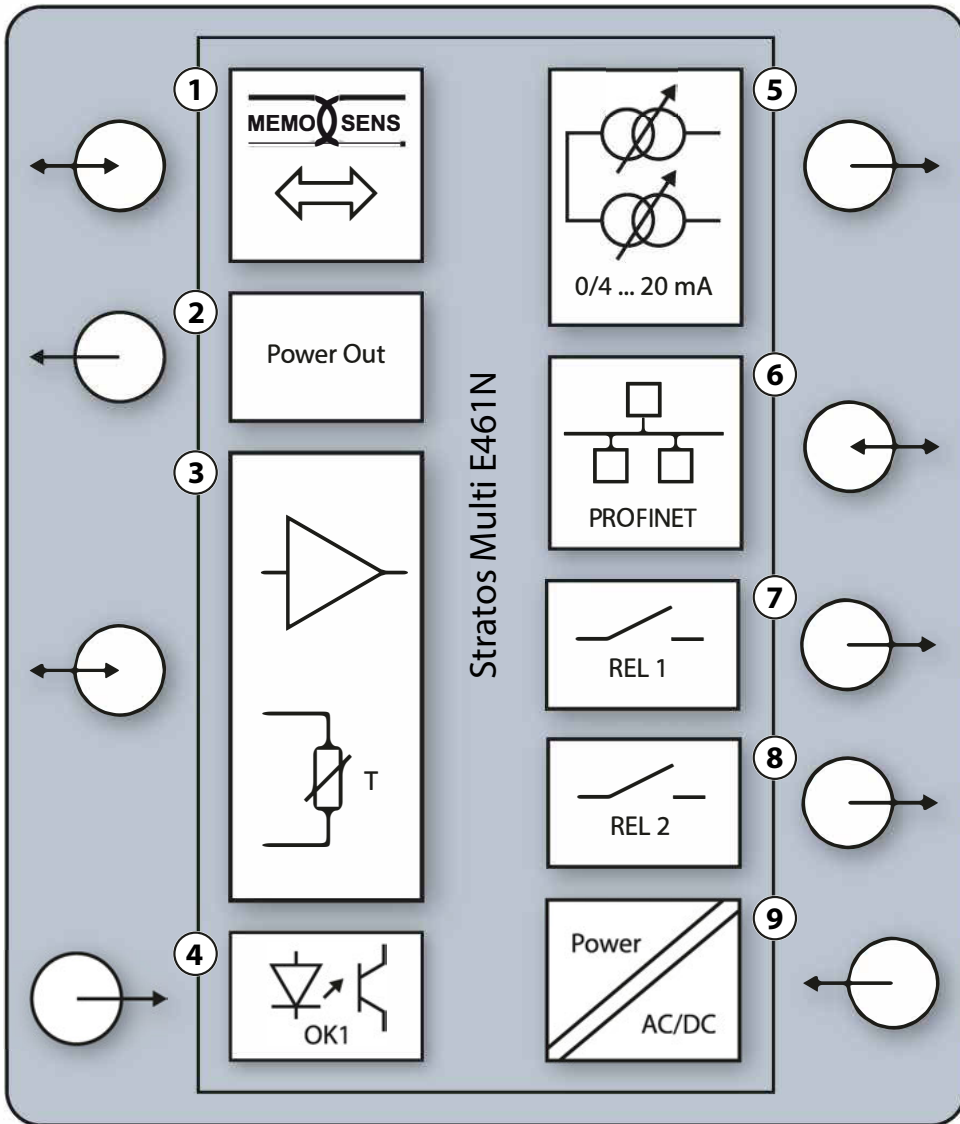

1	Input for Memosens sensors or SE740 optical oxygen sensor	6	PROFINET interface
2	Power output 3/15/24 V for SE740 optical oxygen sensor or external transmitter	7	Relay contact K1: Messages, limits, rinse contact, ...
3	Port for an analog MK module or Memosens via MK-MS module	8	Relay contact K2: Messages, limits, rinse contact, ...
4	Octocoupler input OK1: Parameter set selection A/B, flow, ...	9	Power input: 80 ... 230 V AC / 24 ... 60 V DC < 15 VA/10 W
5	Current output 1, 2: Active or passive		

Note: PROFINET and the current outputs may not be used at the same time.

2.4 Package Contents and Product Identification

- Basic unit Stratos Multi (front and rear units)
- Bag containing small accessory parts (2x plastic sealing plugs, 1x hinge pin, 1x plate for conduits, 2x insertable jumpers, 1x reduction sealing insert, 1x multiple sealing insert, 2x blanking plugs, 5x cable glands, and M20x1.5 hex nuts)
- Test report 2.2 according to EN 10204
- Installation Guide
- Safety Guide

Note: The User Manual (this document) is published in electronic form. → knick.de

Note: Check all components for damage upon receipt. Do not use damaged parts.

Measuring modules are not included in the basic unit's package contents.

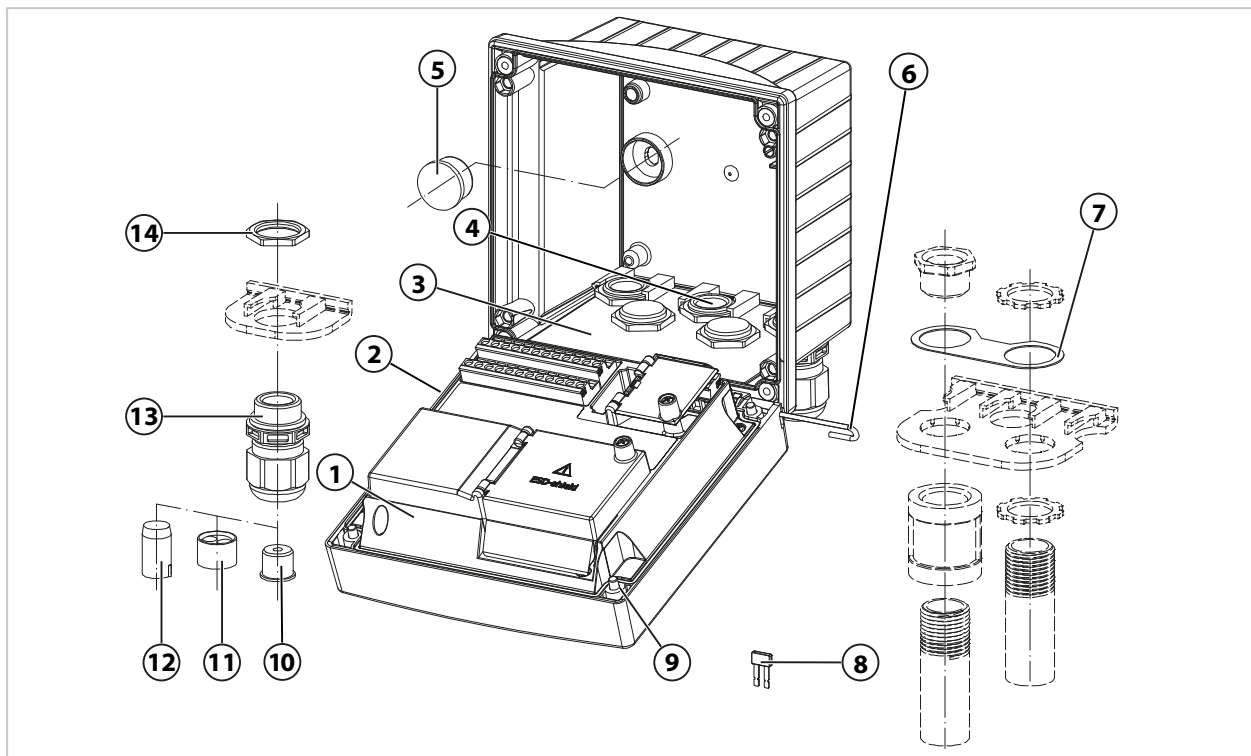

1 Front unit	8 Insertable jumper (2x)
2 Circumferential seal	9 Enclosure screw (4x)
3 Rear unit	10 Reduction sealing insert (1x)
4 Holes for cable glands	11 Multiple sealing insert (1x)
5 Plastic sealing plug (2x), for sealing in case of wall mounting	12 Blanking plug (2x)
6 Hinge pin (1x), insertable from either side	13 Cable gland (5x)
7 Plate (1x), for conduit mounting: Place washer between housing and nut	14 Hex nut (5x)

2.4.1 Nameplate

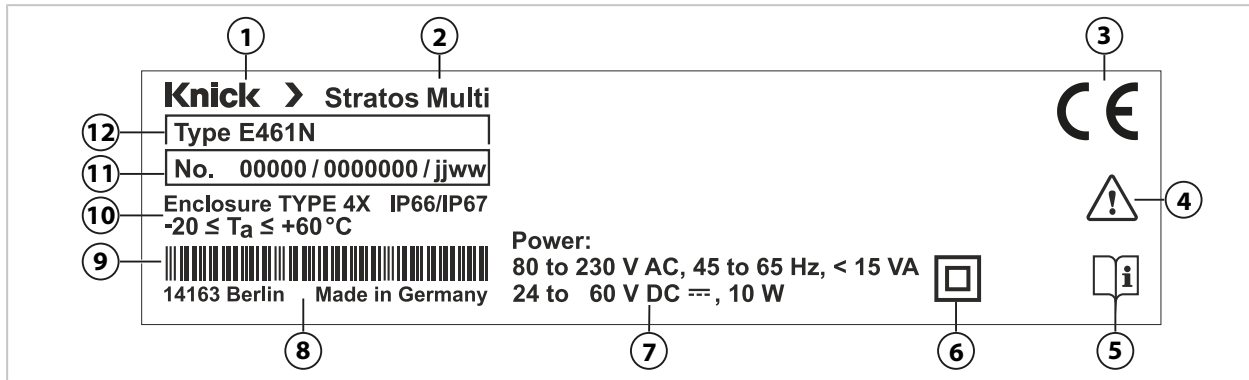

1	Manufacturer	7	Power supply
2	Product name	8	Manufacturer's address with designation of origin
3	CE mark	9	Barcode: Item production number, serial number, check digit
4	Special conditions and danger points	10	Protection, permissible ambient temperature
5	Reminder to read the documentation	11	Product number/serial number/production year and week
6	Protection class II	12	Model designation

You can view the device type, serial number, and firmware, hardware, and bootloader versions of your device in the Diagnostics menu: [Menu Selection](#) ▶ [Diagnostics](#) ▶ [Device Information](#)

→ *Device Information, p. 155*

3 Installation

3.1 Housing Mounting Options

Knockouts in the rear unit enable different mounting options:

- Wall mounting → *Dimension Drawings*, p. 20
- Pipe mounting → *Pipe-Mount Kit ZU0274*; p. 22
- Panel mounting → *Panel-Mount Kit ZU0738*, p. 24
- Protective hood → *Protective Hood for Wall and Pipe Mounting ZU0737*, p. 23

Cable glands for connecting sensors:

- 3 knockouts for M20x1.5 cable glands
→ *Blanking Plugs, Reduction Sealing Inserts, Multiple Sealing Inserts*, p. 25
- 2 knockouts for M20x1.5 or NPT 1/2" cable glands or rigid metallic conduit

3.2 Enclosure, Mounting Possibilities

⚠ CAUTION! Risk of losing the specified ingress protection. Observe the permissible cable diameters and tightening torques. Fasten the cable glands and screw together the housing correctly. Do not contaminate or damage the circumferential seal.

NOTICE! Potential product damage. Use only a suitable Phillips head screwdriver to open and close the enclosure. Do not use sharp or pointed objects. Tighten the screws with a torque of 0.5 ... 2 Nm.

Note: Install the hinge pin to prevent tensile strain on the measuring cables when replacing the front unit. Imprecise measuring values may result if this is not done.

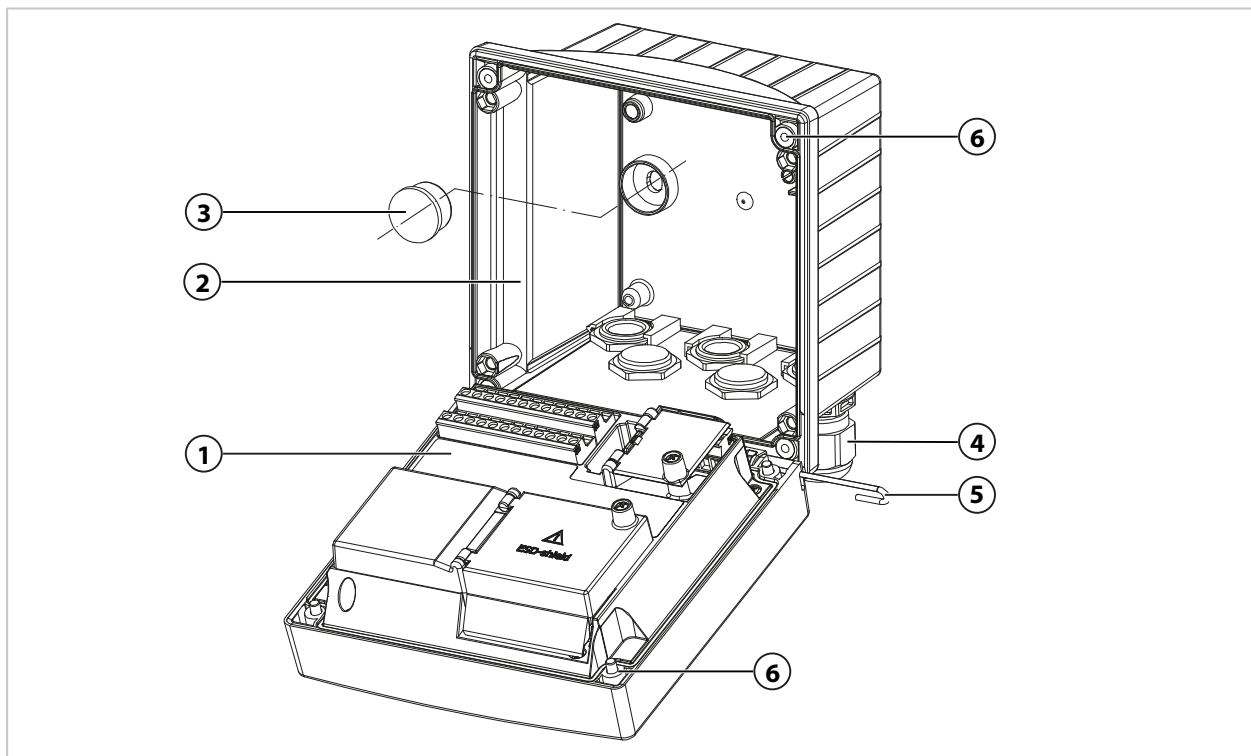

01. Select mounting type and install.

- ✓ Wall mounting → *Wall Mounting*, p. 20
- ✓ Pipe mounting → *Pipe-Mount Kit ZU0274*; p. 22
- ✓ Panel mounting → *Panel-Mount Kit ZU0738*, p. 24

02. Following wall mounting, seal the holes with plastic sealing plugs (3).

03. Install the cable glands **(4)** from the bag containing small accessory parts in the rear unit.
 - *Package Contents and Product Identification, p. 16*
 - *Blanking Plugs, Reduction Sealing Inserts, Multiple Sealing Inserts, p. 25*
04. Pass the required cables through the cable glands.
05. Seal unused cable glands with blanking plugs.
06. Insert the hinge of the front unit **(1)** into the rear unit **(2)** and connect both parts with the hinge pin **(5)**.
07. Insert any modules. → *Connecting an Analog Sensor/Second Memosens Channel, p. 32*
08. Connect the cables.
 - *Electrical Installation, p. 26*
 - *Connecting a Memosens Sensor/Optical Oxygen Sensor (LDO), p. 31*
09. Open the front unit and tighten the captive enclosure screws **(6)** on the front of the front unit **(1)** in diagonal sequence using a Phillips head screwdriver. Torque 0.5 ... 2 Nm

3.3 Dimension Drawings

3.3.1 Wall Mounting

Note: All dimensions are given in millimeters [inches].

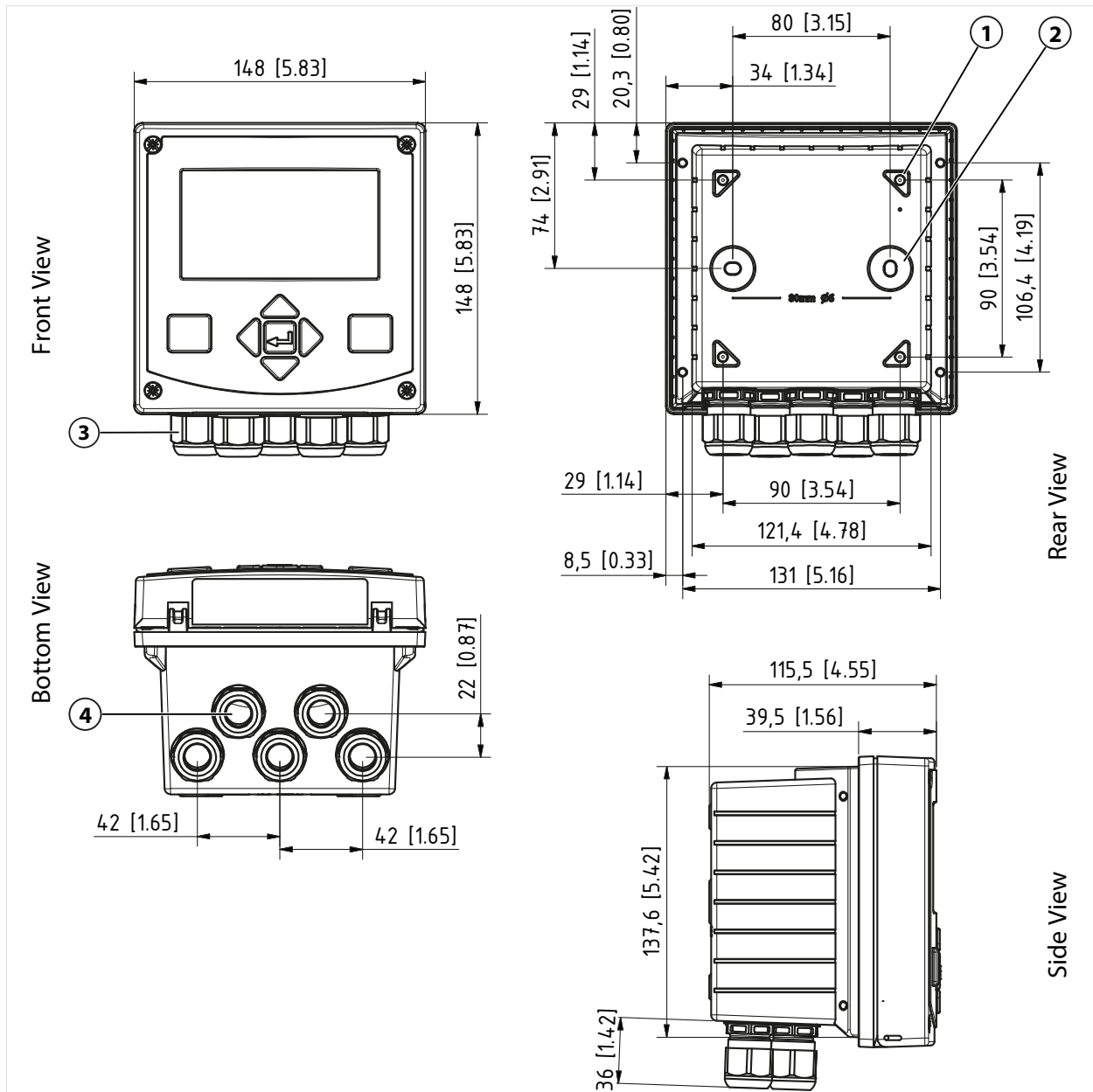

- | | |
|---|---|
| 1 Holes for pipe mounting, 4x | 3 Cable glands, 5x |
| 2 Holes for wall mounting, 2x
Sealing with plastic sealing plugs | 4 Holes for cable glands or 1/2" conduit, ø 21.5 mm, 2x |

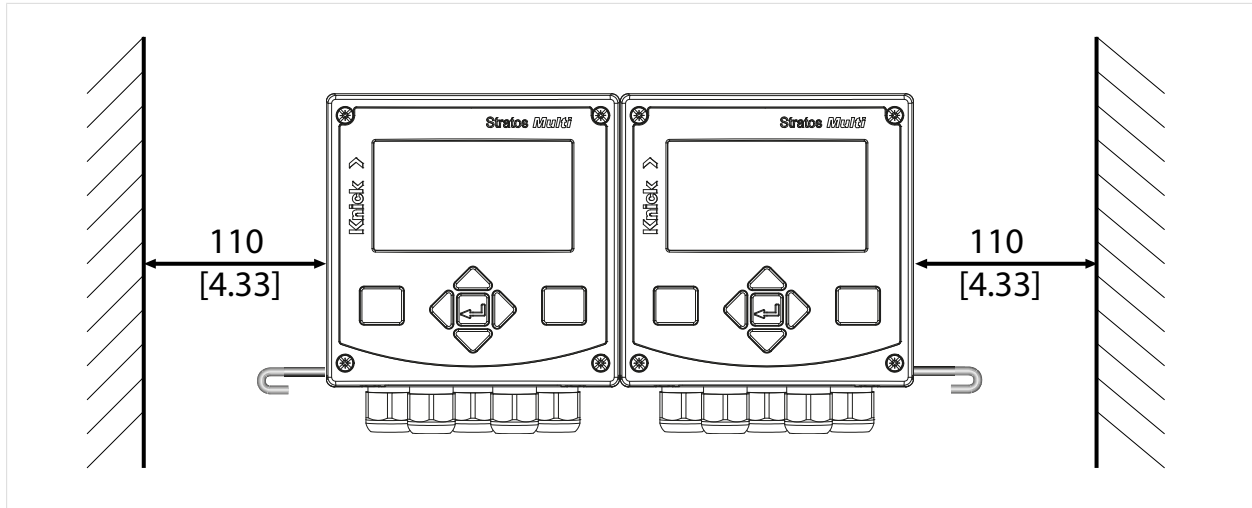
Mounting Clearance

There is a 100 mm hinge pin in the bag containing small accessory parts included in the package contents → *Package Contents and Product Identification*, p. 16. The hinge pin connects the front and rear units. Depending on space requirements, the hinge pin can be inserted on the left or right. In order to replace the front unit, a minimum clearance of 110 mm [4.33 inches] must be maintained on the relevant side.

3.3.2 Pipe-Mount Kit ZU0274:

Note: All dimensions are given in millimeters [inches].

Pipe dimensions:

Diameter 40 ... 60 mm [1.57 ... 2.36"] or edge length 30 ... 45 mm [1.18 ... 1.77"]

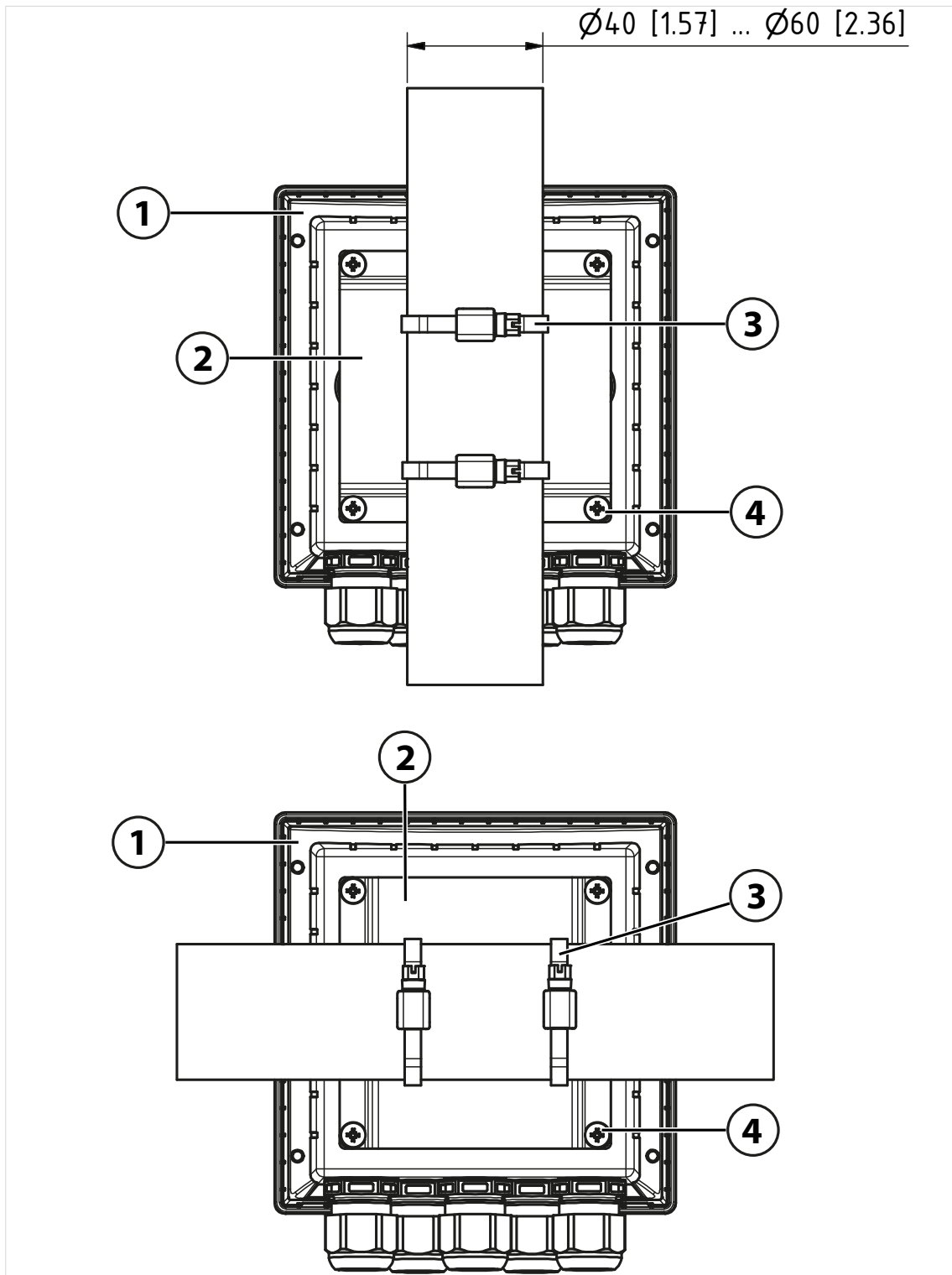

1 For vertical or horizontal posts or pipes

3 Hose clamp with worm gear drive according to DIN 3017, 2x

2 Pipe-mount plate, 1x

4 Self-tapping screw, 4x

3.3.3 Protective Hood for Wall and Pipe Mounting ZU0737

Note: All dimensions are given in millimeters [inches].

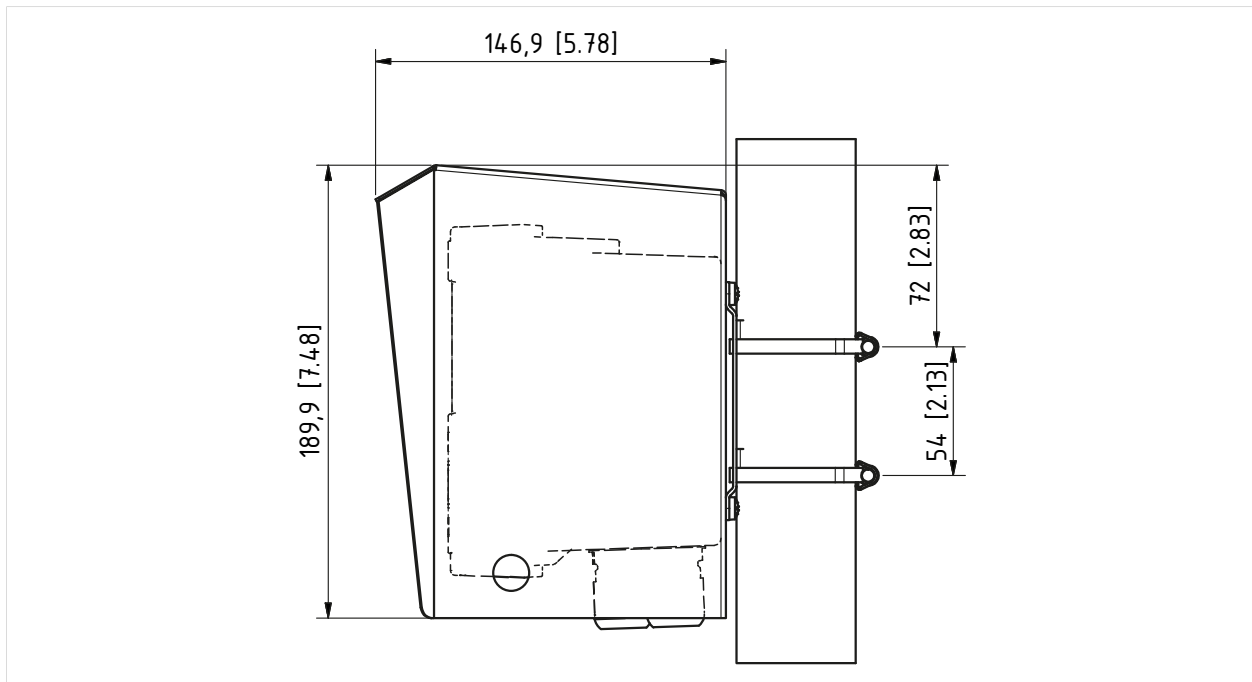

The protective hood can only be used for wall or pipe mounting.

The package contents includes 4 M6 nuts for fastening the protective hood on the threaded rod of the pipe-mount kit.

3.3.4 Panel-Mount Kit ZU0738

Note: All dimensions are given in millimeters [inches].

Cutout 138 mm x 138 mm (DIN 61554)

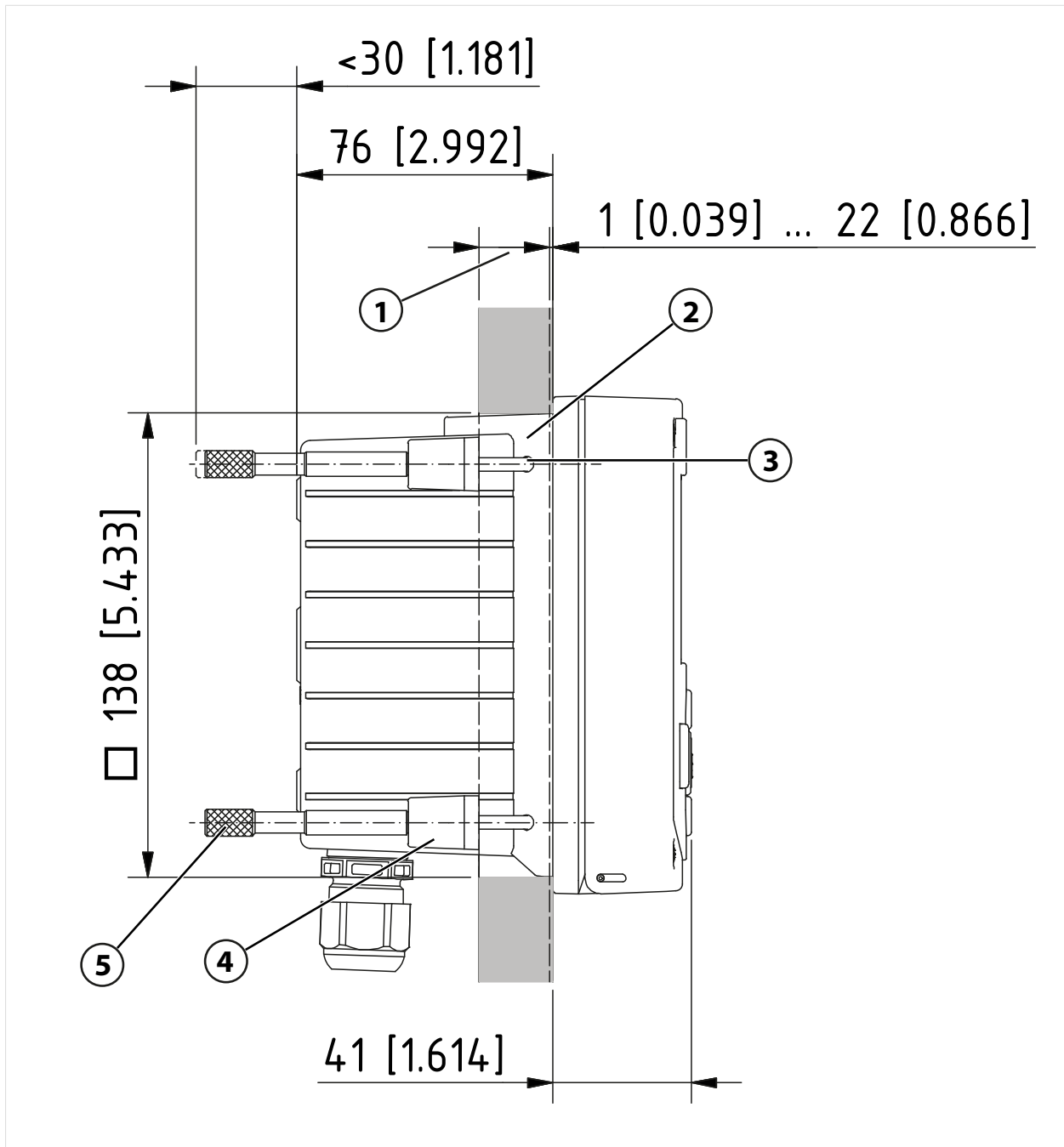

1 Control panel	4 Span piece, 4x
2 Circumferential seal, 1x	5 Threaded sleeve, 4x
3 Screw 60.0 x 4.0 mm, 4x	

3.4 Blanking Plugs, Reduction Sealing Inserts, Multiple Sealing Inserts

As delivered, each cable gland includes a standard sealing insert. Reduction and multiple sealing inserts are available for tight insertion of one or two thinner cables. The coupling can be tightly sealed using a blanking plug. Handling is as shown below.

⚠ CAUTION! Risk of losing the specified ingress protection. Fasten the cable glands and screw together the housing correctly. Observe the permissible cable diameters and tightening torques. Only use original accessories and spare parts.

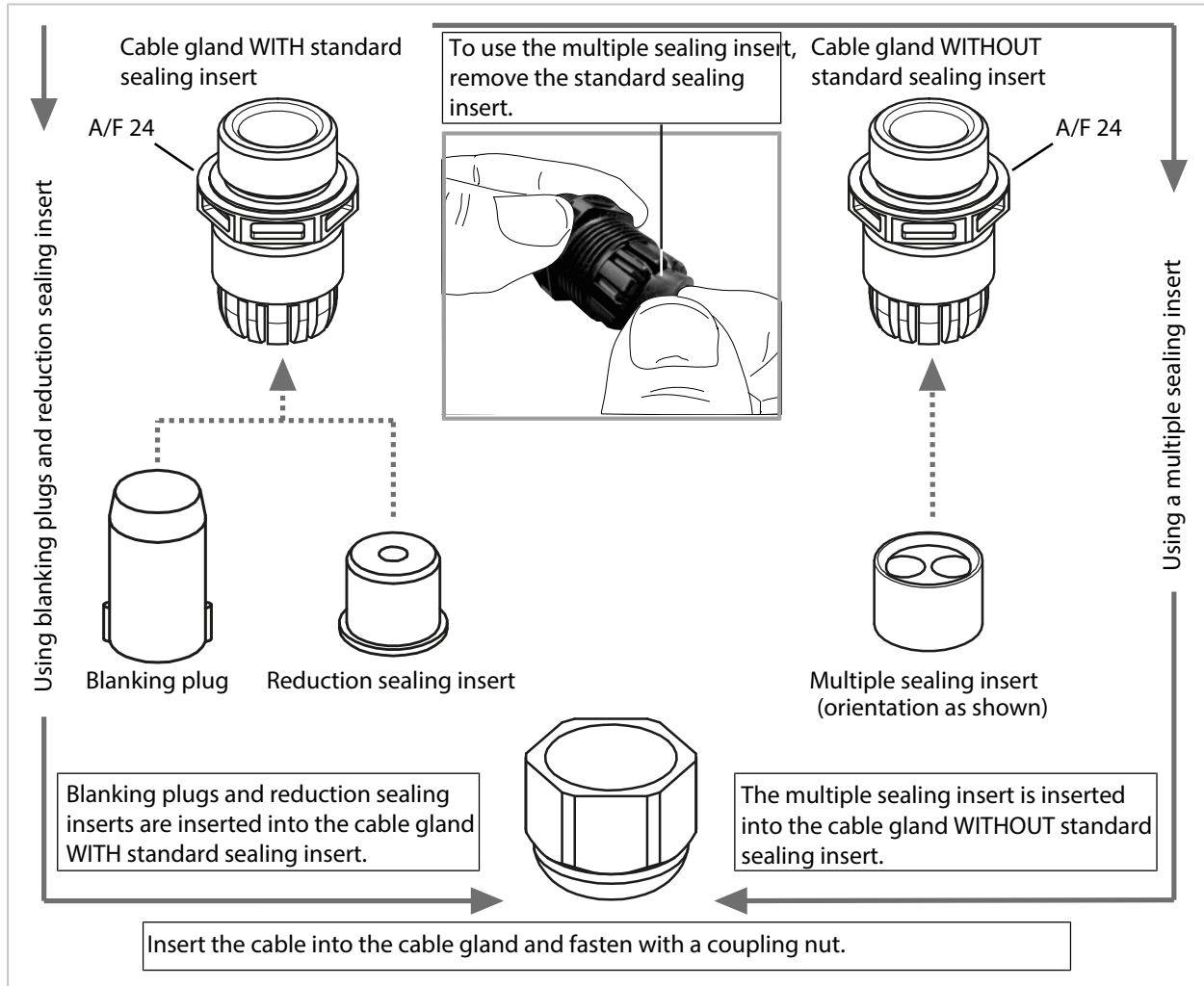

3.5 Electrical Installation

Terminals

Rear of front unit

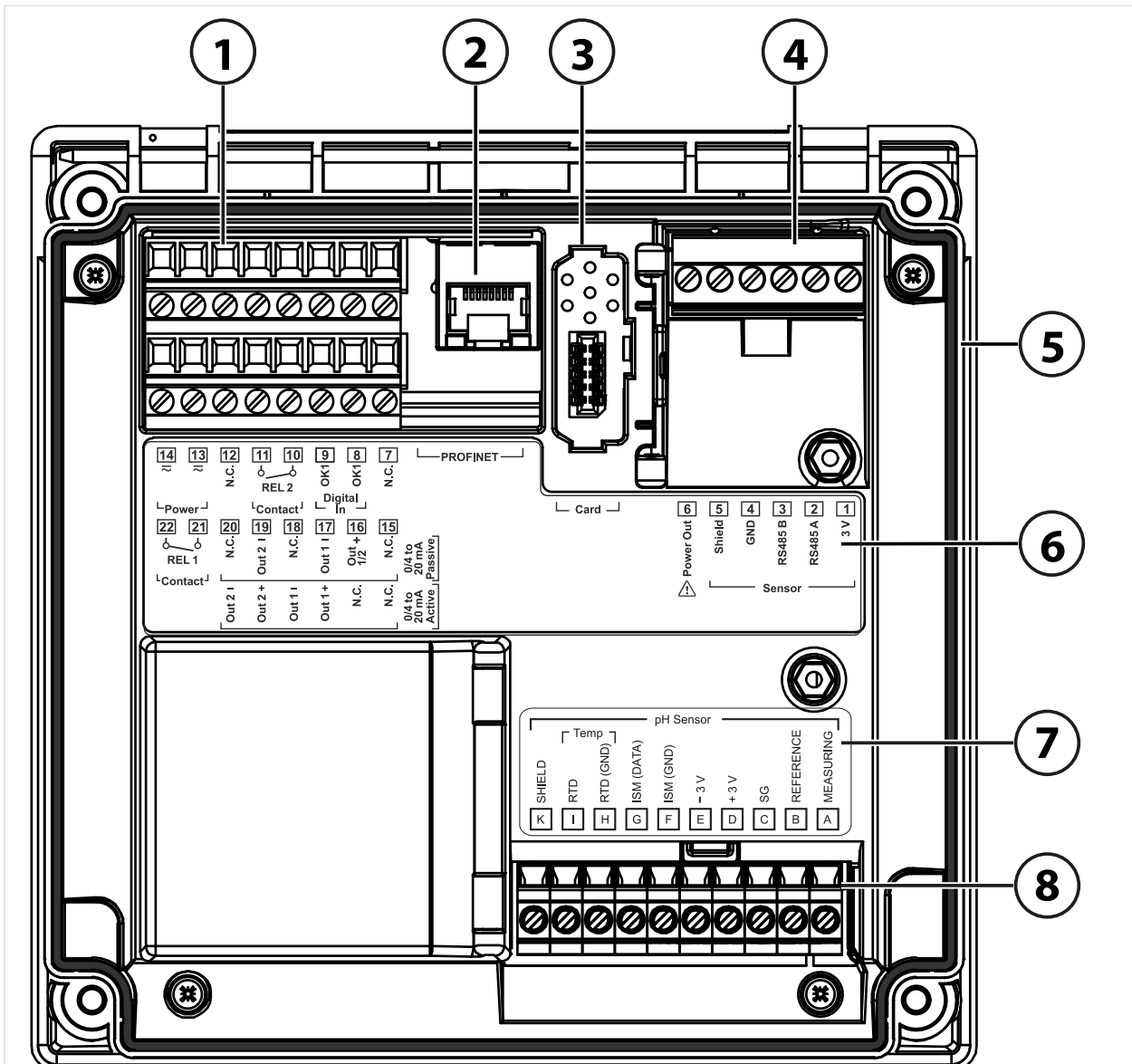

- | | |
|--|--|
| <ul style="list-style-type: none"> 1 Terminals for inputs, outputs, relay contacts, power supply 2 RJ45 socket for PROFINET 3 Slot for memory card (ZU1080-S-*_*) 4 RS-485 interface: Connection for Memosens/ optical sensors (SE740) | <ul style="list-style-type: none"> 5 Circumferential seal 6 Terminal plate 7 Module plate sticker, example of pH module 8 Connected measuring module |
|--|--|

Terminal Assignments

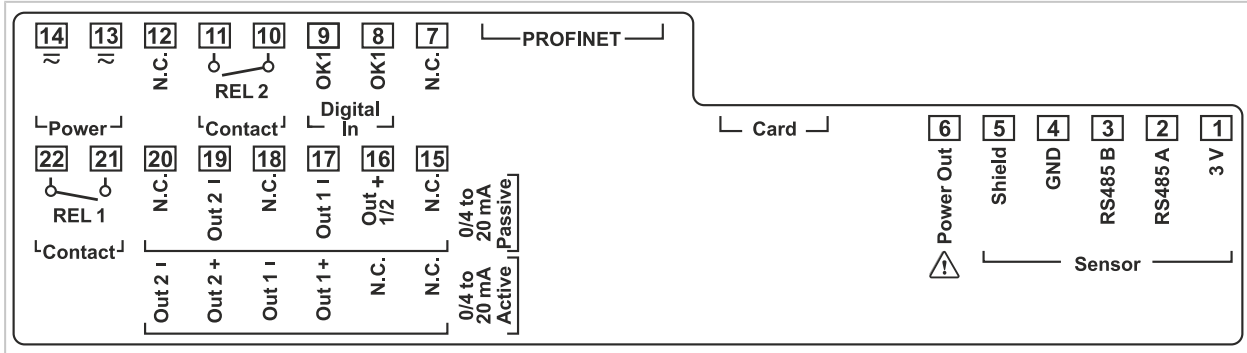

Terminal	Connection		
Sensor (Memosens or other digital sensor)	1	3 V	
	2	RS485 A	
	3	RS485 B	
	4	GND	
	5	Shield	
	6	Power out	Power supply output to supply power to special sensors or external transmitters
	Card	Memory card	
	PROFINET	RJ45 socket	
	7	N.C., no connection	
Digital control input Optocoupler input	8	OK1	
	9	OK1	
Relay contact REL 2	10	Relay 2	Contact rating → Specifications, p. 189
	11	Relay 2	
	12	N.C., no connection	
Power supply 24 V ... 230 V AC/DC	13	Power	Power supply input
	14	Power	
Current outputs Out 1/2 (0)4 mA ... 20 mA		Active	Passive
	15	N.C., no connection	N.C., no connection
	16	N.C., no connection	+ Out 1/2
	17	+ Out 1	- Out 1
	18	- Out 1	N.C., no connection
	19	+ Out 2	- Out 2
	20	- Out 2	N.C., no connection
Relay contact REL 1	21	Relay 1	Contact rating → Specifications, p. 189
	22	Relay 1	

⚠ WARNING! The transmitter does not have a power switch. An appropriately arranged and accessible disconnecting device for the transmitter must be present in the system installation. The disconnecting device must disconnect all non-grounded, current-carrying wires and be labeled such that the associated transmitter can be identified.

⚠ WARNING! The power line may carry dangerous touch voltages. Always install the product with the power off. Secure the system against unintentional restart.

NOTICE! Strip the insulation from the wires using a suitable tool to prevent damage. Stripping length max. 7 mm.

NOTICE! Damage to the screw terminals due to excessive tightening torque. Tighten the screw terminals with a max. torque of 0.6 Nm.

01. Before commencing with the installation, make sure that all lines to be connected are de-energized.
02. Wire the connections.
 - *Ethernet Connection, p. 28*
 - *Installing Active and Passive Current Outputs, p. 29*
 - *Relay Contacts: Protective Wiring, p. 29*
03. Deactivate unused current outputs in the parameter settings or use insertable jumpers.
 - *Current Outputs, p. 57*
04. Connect the power supply cables.
05. When measuring with analog sensors or a second Memosens sensor: Insert the measuring module into the module slot. → *Connecting an Analog Sensor/Second Memosens Channel, p. 32*
06. Connect the sensor(s). → *Sensor Connection, p. 31*
07. Check whether all connections are correctly wired.
08. Open the front unit and tighten the enclosure screws in a diagonal sequence using a Phillips head screwdriver. Torque 0.5 ... 2 Nm
09. Before switching on the power supply, make sure its voltage is within the specified range (values → *Specifications, p. 189*).
10. Switch on the power supply.

3.5.1 Ethernet Connection

Star topology:

- Adapter cable RJ45/M12 D type ZU1073
- PROFINET cable with RJ45 socket ZU1072
- PROFINET cable with user-configured connector

Ring topology:

- Adapter cable RJ45/M12 A type ZU1166 with Y cable M12 A type/D type ZU1164 and RJ45 socket ZU1072

Note: To ensure correct data transmission, a suitable PROFINET cable must be connected to the RJ45 socket.

Ring Topology Connection

Stratos Multi E461N supports two Ethernet interfaces for connection in a ring topology. In this case, the ZU1166 adapter cable connected to the ZU1164 Y cable is connected to the RJ45 socket

RJ45 Socket Wiring

Pin	Name	PN Port	M12 Socket 1 with ZU1166 Adapter Cable and ZU1164 Y Cable	M12 socket 2 with ZU1166 Adapter Cable and ZU1164 Y Cable	Description
1	TX1+	2 (PHY1)	Pin 1		Transmitted data +
2	TX1-	2 (PHY1)	Pin 3		Transmitted data -
3	RX1+	2 (PHY1)	Pin 2		Received data +
4	TX0+	1 (PHY0)		Pin 1	Transmitted data +
5	TX0-	1 (PHY0)		Pin 3	Transmitted data -
6	RX1-	2 (PHY1)	Pin 4		Received data -
7	RX0+	1 (PHY0)		Pin 2	Received data +
8	RX0-	1 (PHY0)		Pin 4	Received data -

Note: PN port 2 (PHY1) is used in the event of a star topology connection.

See also

→ *Accessories, p. 182*

3.5.2 Installing Active and Passive Current Outputs

The current outputs directly supply current (0/4 ... 20 mA) to a load according to the selected process variable.

Passive current outputs require an external supply voltage.

Note: Observe the specifications and connected loads. → *Specifications, p. 189*

Terminal Assignment Diagram

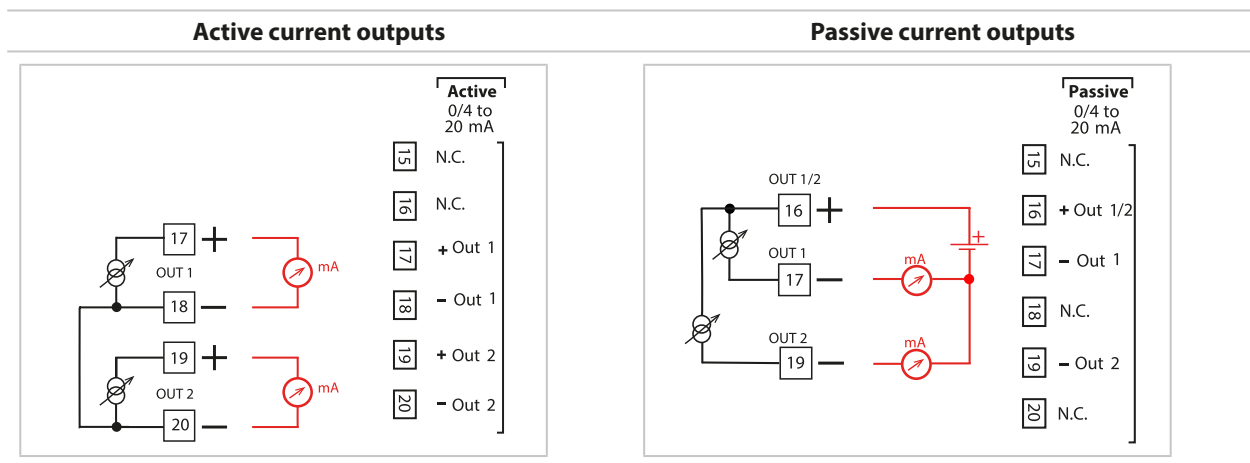

3.5.3 Relay Contacts: Protective Wiring

Relay contacts are subject to electrical erosion. Especially with inductive and capacitive loads, the service life of the contacts will be reduced. For suppression of sparks and arcing, components such as RC combinations, nonlinear resistors, series resistors, and diodes should be used.

NOTICE! Make sure that the maximum ratings of the relay contacts are not exceeded, even during switching. → *Specifications, p. 189*

Information Concerning Relay Contacts

As delivered, the relay contacts are suitable for low signal currents (down to approx. 1 mA). If currents above approx. 100 mA are switched, the gold plating is destroyed during the switching process. After that, the contacts will not reliably switch low currents.

Configuration of relay contacts → *Relay Contacts, p. 60*

Wiring of relay contacts → *Electrical Installation, p. 27*

Typical AC Application with Inductive Load

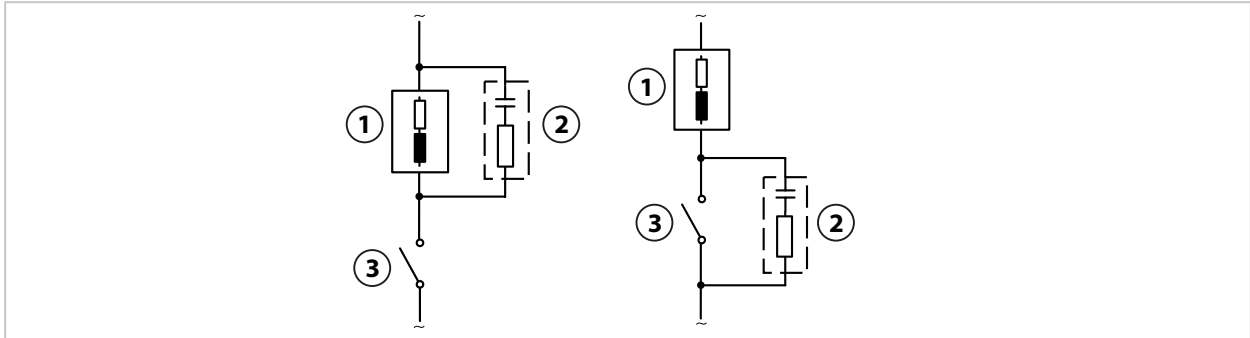

- 1 Load
- 2 Typical RC combination, e.g., capacitor 0.1 μF, resistor 100 Ω/1 W
- 3 Contact

Typical DC Application with Inductive Load

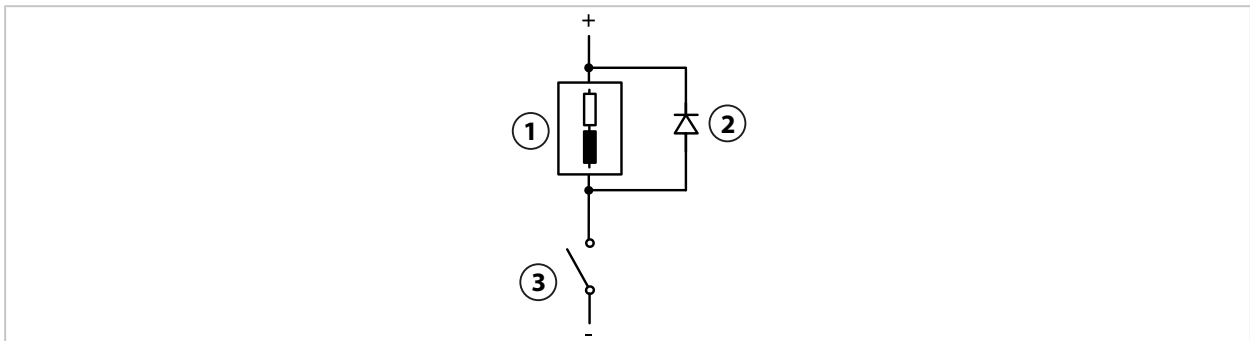

- 1 Inductive load
- 2 Free-wheeling diode, e.g., 1N4007 (observe polarity)
- 3 Contact

Typical AC/DC Application with Capacitive Load

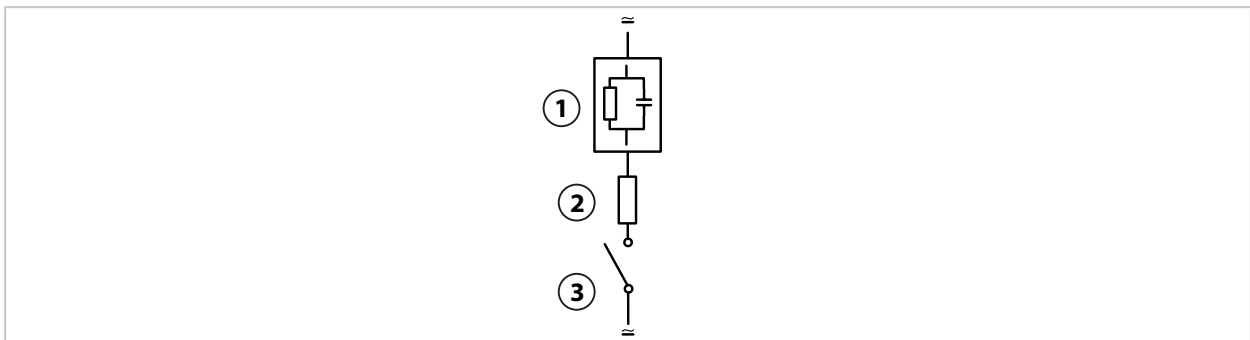

- 1 Capacitive load
- 2 Resistor e.g., 8 Ω/1 W at 24 V/0.3 A
- 3 Contact

3.6 Sensor Connection

3.6.1 Connecting a Memosens Sensor/Optical Oxygen Sensor (LDO)

Top view of terminals for Memosens/LDO sensor. The figure shows the opened device, rear side of the front unit.

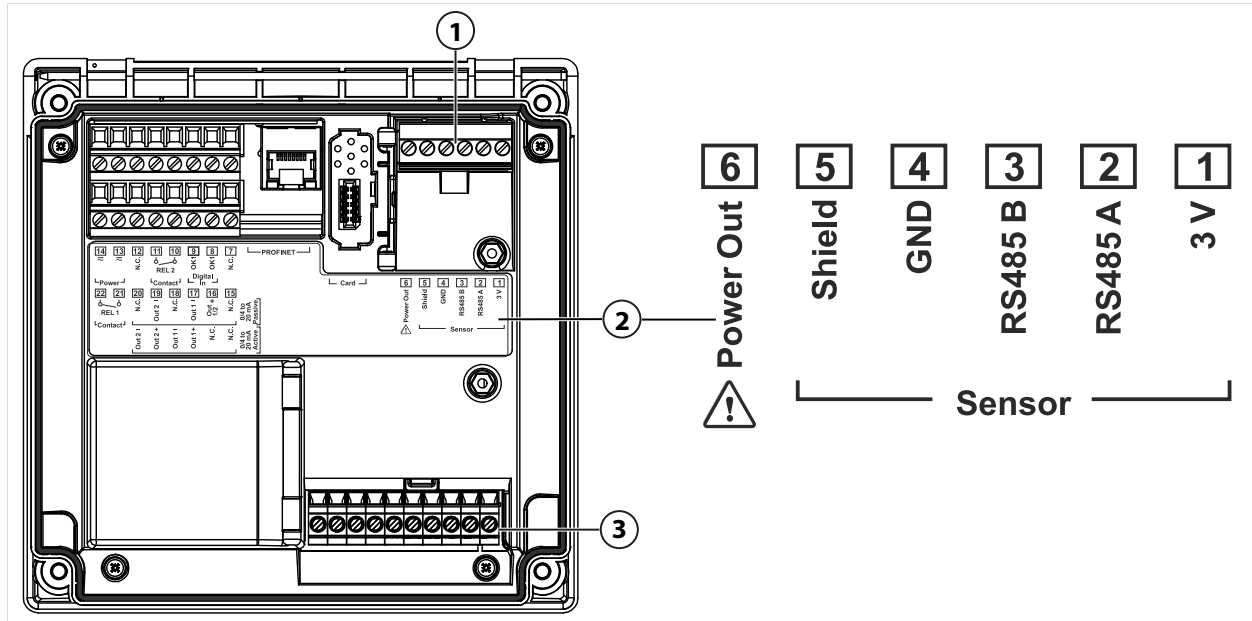

- 1 RS-485 interface: Standard sensor connection for digital sensors (Memosens sensor/LDO SE740 sensor)
- 2 Terminal plate with terminal assignments for digital sensor
- 3 Sensor connection for analog sensors or second Memosens sensor via measuring module

Memosens Sensor			SE740 Optical Oxygen Sensor (LDO)		
Terminal	Wire color	Memosens cable wiring	Terminal	Wire color	M12 cable wiring
1	Brown	+3V	1	-	
2	Green	RS-485 A	2	Gray	RS-485 A
3	Yellow	RS-485 B	3	Pink	RS-485 B
4	White	GND	4	Brown	GND
5	Transparent	Shield	5	-	-
6			6	White	Power Out

01. Using an appropriate sensor cable, connect a Memosens sensor or the SE740 optical oxygen sensor (LDO) to the RS-485 interface (1) of the Stratos Multi.

02. Close the device and tighten the screws on the front.

03. Then select a measuring function and configure the sensor:
From within measuring mode, press the **left softkey: Menu**.

✓ The **Menu Selection** opens.

04. Select **Parameter Setting** ▶ **Sensor Selection** [I] [III].

Note: Function check (HOLD) is active.

05. Press **enter** to open the **Sensor Selection** [I].

06. Select process variable, mode, and functionality, and confirm with **enter**.
Set further parameters with the **left softkey: Back**.

07. Return to measuring mode to end configuration, e.g., with the **right softkey: Back to Meas**.

3.6.2 Connecting an Analog Sensor/Second Memosens Channel

⚠ CAUTION! Electrostatic discharge (ESD). The modules' signal inputs are sensitive to electrostatic discharge. Take measures to protect against ESD before inserting the module and wiring the inputs.

NOTICE! Strip the insulation from the wires using a suitable tool to prevent damage. Stripping length max. 7 mm.

Measuring Modules for Connection of Analog Sensors: pH, ORP, Oxygen, Conductivity

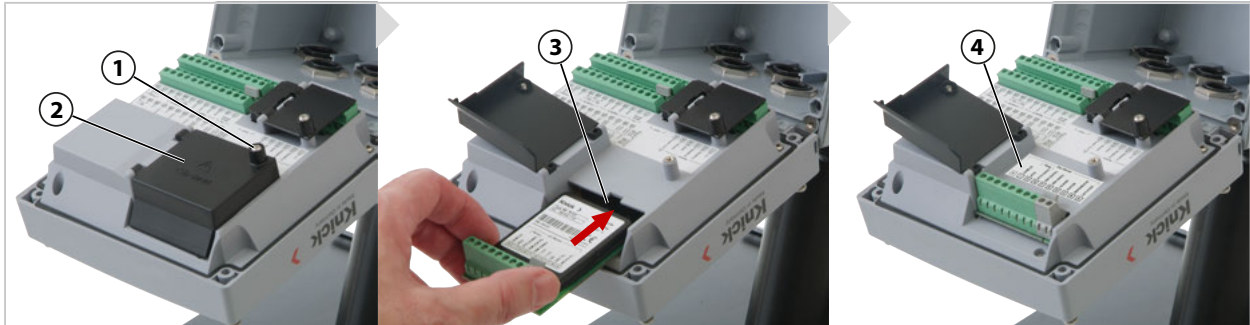

01. Switch off the power supply to the device.
02. Open the device (loosen the 4 screws on the front).
03. Loosen screw **(1)** on the module cover **(2)** ("ESD shield") and open the cover.
04. Insert the module into the module slot **(3)**.
05. Attach the module plate sticker **(4)**.
06. Connect the sensor and separate temperature probe, if necessary.
→ Channel II Wiring Examples, p. 202

⚠ CAUTION! Risk of losing the specified ingress protection. Fasten the cable glands and screw together the housing correctly. Observe the permissible cable diameters and tightening torques. Only use original accessories and spare parts.

07. Check whether all connections are correctly wired.
08. Close the module cover **(2)**, tighten screw **(1)**.
09. Close the device and tighten the screws on the front.
10. Switch on the power supply.

Now select a measuring function and configure the sensor

01. From within measuring mode, press the **left softkey: Menu**.
✓ The **Menu Selection** opens.
02. Select **Parameter Setting** ▶ **Sensor Selection [I] [II]**.

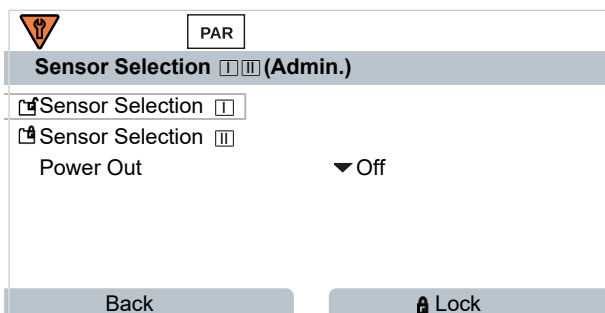

Note: Function check (HOLD) is active.

03. Press **enter** to open the **Sensor Selection [II]**.

04. Select the module and mode, and confirm with **enter**.
Set further parameters with the **left softkey: Back**.
05. Return to measuring mode to end configuration, e.g., with the **right softkey: Back to Meas**.

Measuring Module for Connection of a Second Memosens Sensor

If you want to measure two process variables using Memosens sensors, you must insert an MK-MS095N Memosens module for the second channel.

01. Insert a Memosens module in the module slot and connect it up (see above).
02. Then select a measuring function and configure the sensor:
From within measuring mode, press the **left softkey: Menu**.
✓ The **Menu Selection** opens.
03. Select **Parameter Setting** ▶ **Sensor Selection [I] [II]**.

Note: Function check (HOLD) is active.

04. Press **enter** to open the **Sensor Selection [II]**.
05. Select module MK-MS.
06. Select process variable, mode, and functionality, and confirm with **enter**.
Set further parameters with the **left softkey: Back**.
07. Return to measuring mode to end configuration, e.g., with the **right softkey: Back to Meas**.

3.7 Terminal Assignments of Measuring Modules

Installation of the measuring modules

→ *Connecting an Analog Sensor/Second Memosens Channel, p. 32*

For the terminal assignments of the connected measuring module, see the module plate sticker (1) under the module cover on the rear of the front unit.

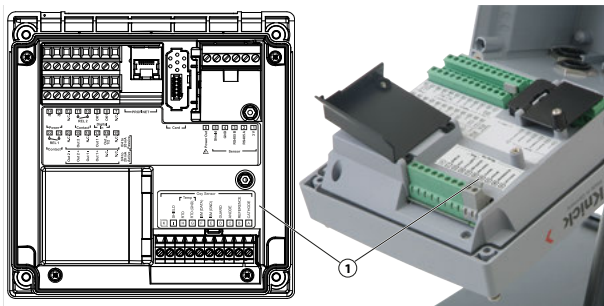

pH/ORP Measuring Module

Order code MK-PH015N

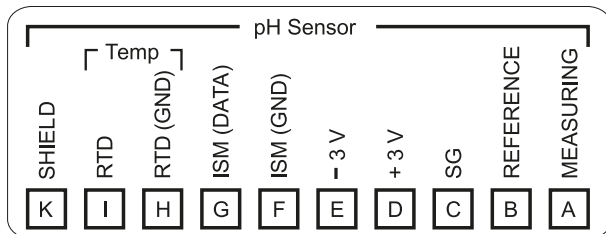

Oxygen Measuring Module

Order code MK-OXY046N

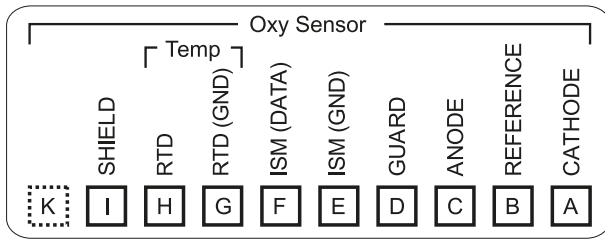

Module for Contacting Conductivity Measurement

Order code MK-COND025N

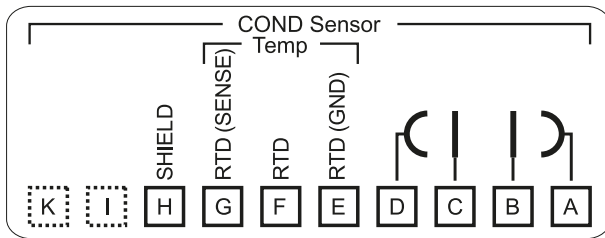

Module for Inductive Conductivity Measurement

Order code MK-CONDI035N

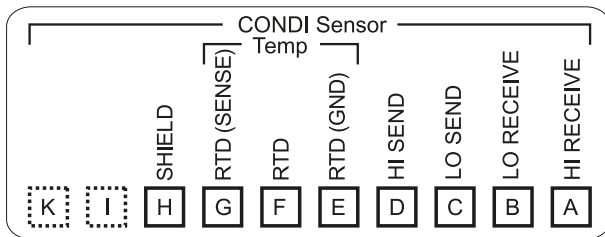

Module for Dual Conductivity Measurement

Order code MK-CC065N

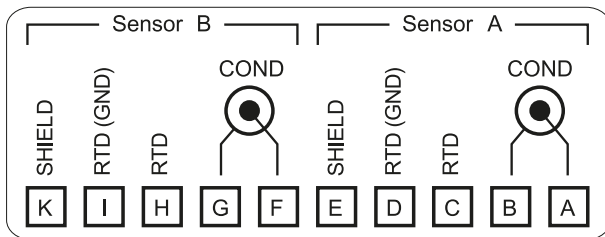

Memosens Module

Order code MK-MS095N

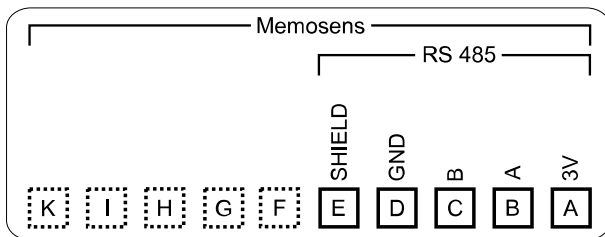

4 Commissioning

Note: Upon request, Knick will provide safety briefings and product training during initial commissioning of the product. More information is available from the relevant local contacts.

01. Install the housing. → *Installation, p. 18*
02. Wire the connections. → *Electrical Installation, p. 26*
03. Connect the sensor(s). → *Sensor Connection, p. 31*
04. Configure the device. → *Parameter Setting, p. 43*
05. Integrate in the PROFINET system. → *PROFINET, p. 104*

4.1 Final Check During Commissioning

- Are the Stratos Multi and all its cables externally intact and strain-relieved?
- Are the cables routed without loops or crossovers?
- Have all the wires been correctly connected in accordance with their terminal assignments?
- Was the tightening torque of the screw terminals correctly adhered to?
- Are all connectors firmly engaged?
- Are all cable glands installed, tight, and leak-proof?
- Is the device closed and correctly screwed together?
- Does the supply voltage (power supply) accord with the voltage indicated on the nameplate?

5 Operation and Use

5.1 Changing the User Interface Language

Requirements

- Stratos Multi is connected to the power.
- Measuring mode is shown on the display.

Steps

01. Press the **left softkey: Menu**. The menu selection opens.
02. Press the **right softkey: Lingua**. Press the right **arrow key** and set the language of the user interface.
03. Confirm with **enter**.

Note: The user interface language can also be changed in the Parameter Setting menu.

Parameter Setting ▶ General ▶ Language → *Parameter Setting, General, p. 51*

5.2 Keypad and Display

Display

Stratos Multi features a 4.3" TFT color graphic display. The Calibration, Maintenance, Parameter Setting, and Diagnostics menus each have their own colors. The device is operated using plain text in various languages. Messages are output as icons and plain text.

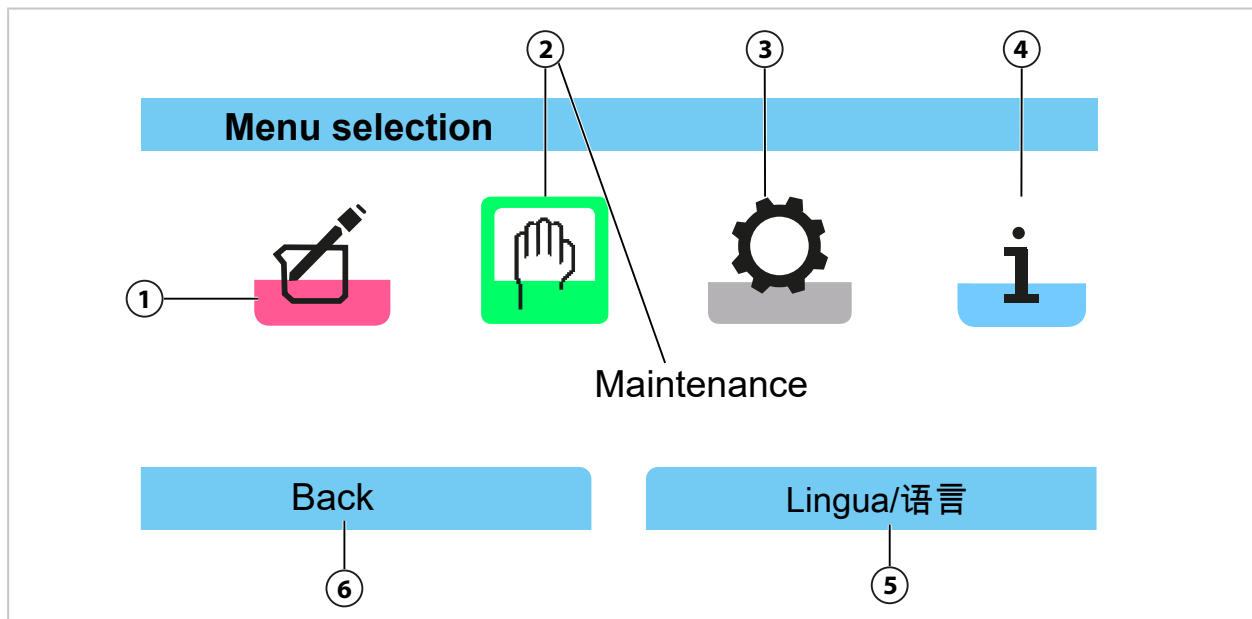

1 Calibration	4 Diagnostics
2 Maintenance (selected)	5 Softkey function: Select language
3 Configuration	6 Softkey function display

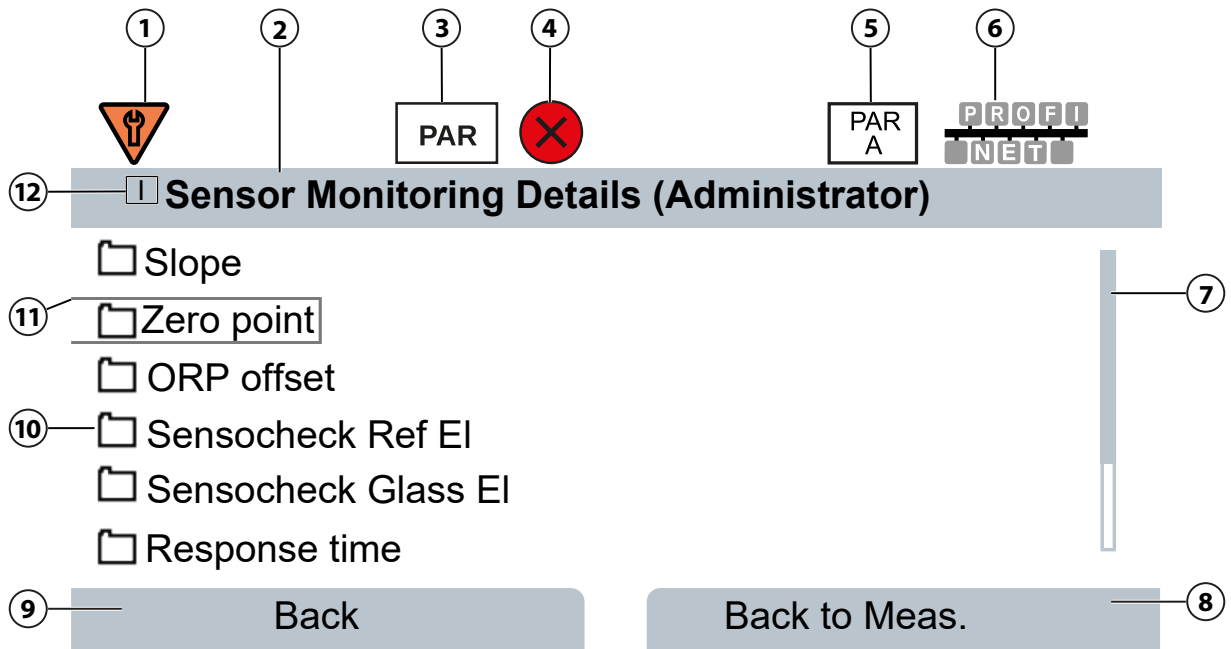

1	Function check (HOLD)	7	Scrollbar
2	Current menu heading	8	Softkey function display
3	Device condition (PAR for parameter setting)	9	Softkey function display
4	Failure is active	10	Folder element
5	Active parameter set	11	Selected element
6	PROFINET control	12	Measuring channel, e.g., channel I

Display of Measuring Channels

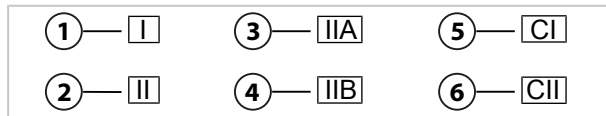

1	Channel I	4	Second channel in MK-CC module
2	Channel II (measuring module)	5	Calculation block 1
3	First channel in MK-CC module	6	Calculation block 2

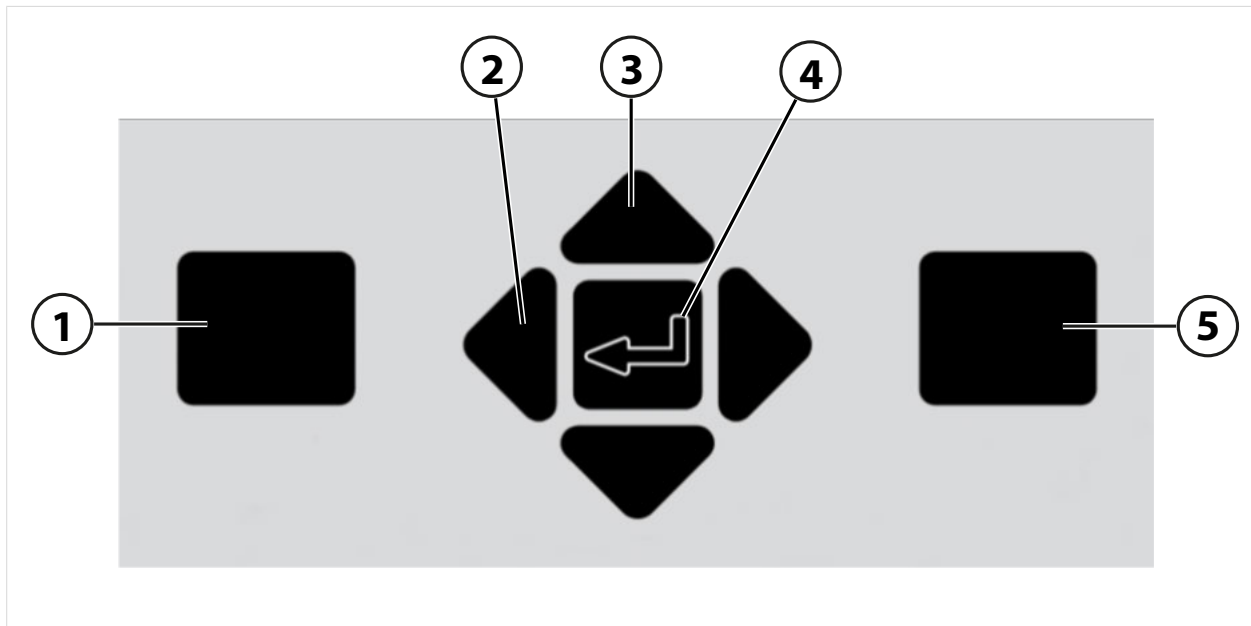
Keypad





















- | | |
|---|--|
| 1 Left softkey:
Function as shown on left function display | 4 enter:
Open menu, confirm inputs |
| 2 Left/right arrow keys:
Menu selection: prior/next menu, move left/right | 5 Right softkey:
Function as shown on right function display |
| 3 Up/down arrow keys:
Row selection from selection window,
increase/decrease a numeral | |

Entering Text and Numbers; Selecting Signs

01. Select a number using the *left/right arrow keys*.
02. Enter numbers or letters using the *up/down arrow keys*.
Change the sign, as required.
03. Switch to signs using the left *arrow key*.
04. Set the sign value with the *up or down arrow keys*.
05. Confirm with *enter*.

Note: If you enter values outside the specified value range, an information window showing the permissible value range is shown.

5.3 Symbols and Markings on the Display

	<p>Function check in accordance with NAMUR NE 107 <i>Wrench symbol on orange background</i> The NAMUR "HOLD" contact is active. Current outputs as configured: Currently measured value: The currently measured value appears at the current output. Last measured value: The last measured value is held at the current output. Fixed value: The current output supplies a fixed value.</p>
	<p>Out of specification in accordance with NAMUR NE 107 <i>Black question mark on yellow background</i> The NAMUR "Out of Specification" contact is active. Error message: Diagnostics ▶ Message List</p>
	<p>Failure in accordance with NAMUR NE 107 <i>Flashing black cross symbol on red background</i> The NAMUR "Failure" contact is active. Error message: Diagnostics ▶ Message List</p>
	<p>Maintenance required in accordance with NAMUR NE 107 <i>Oil can symbol on blue background</i> The NAMUR "Maintenance Required" contact is active. Error message: Diagnostics ▶ Message List</p>
	<p>PROFINET is used for control. → <i>PROFINET, p. 104</i></p>
	<p>The device is in calibration mode. Function check (HOLD) is active.</p>
	<p>The device is in maintenance mode. Function check (HOLD) is active.</p>
	<p>The device is in parameter mode. Function check (HOLD) is active.</p>
	<p>The device is in diagnostics mode.</p>
	<p>The device is in measuring mode.</p>
	<p>Selectable parameter sets (A/B). Indicates which parameter set is currently active when a control element for parameter set selection was selected:</p>
	<p>Parameter Setting ▶ System Control ▶ Function Control</p>
	<p>A "closed" Data Card (memory card) is located in the device. The memory card can be removed. If you want to continue using the card, select "Open Memory Card" in the Maintenance menu.</p>
	<p>There is an enabled Data Card (memory card) in the device. Note: Select "Close Memory Card" in the Maintenance menu before removing the memory card.</p>
	<p>There is an FW Update Card (memory card) in the device. You can save the current device firmware or perform a firmware update from the memory card Note: Check the parameter settings after updating.</p>
	<p>Free firmware repair in the event of device errors. The TAN option FW-E106 is not required here. General data cannot be stored on this card.</p>
	<p>Designates the measuring channel for clear assignment of measured-value/parameter displays in the case of identical process variables.</p>
	<p>Channel I: Memosens sensor/SE740 optical oxygen sensor (LDO) Channel II: Measuring module for analog sensor or second Memosens sensor</p>
	<p>Channel IIA: First channel in MK-CC module</p>
	<p>Channel IIB: Second channel in MK-CC module</p>

	Channel CI: Calculation block 1 Channel CII: Calculation block 2
---	---

	To the left of a menu line that contains a further menu level. Pressing Enter opens the submenu.
---	--

	To the left of a menu line that, at administrator level, can be blocked from access at operator level.
---	--

	To the left of a menu line that, at administrator level, was blocked from access at operator level.
---	---

	When in measuring mode, Sensoface smileys indicate the quality of the sensor data: Happy
---	---

	Neutral
---	---------

	Sad
---	-----

	Wait; device is busy.
---	-----------------------

	Product calibration was not completed. The lab value still needs to be entered.
---	---

	To the left of a Diagnostics menu item set as a "Favorite".
--	---

5.4 Menu Structure Overview

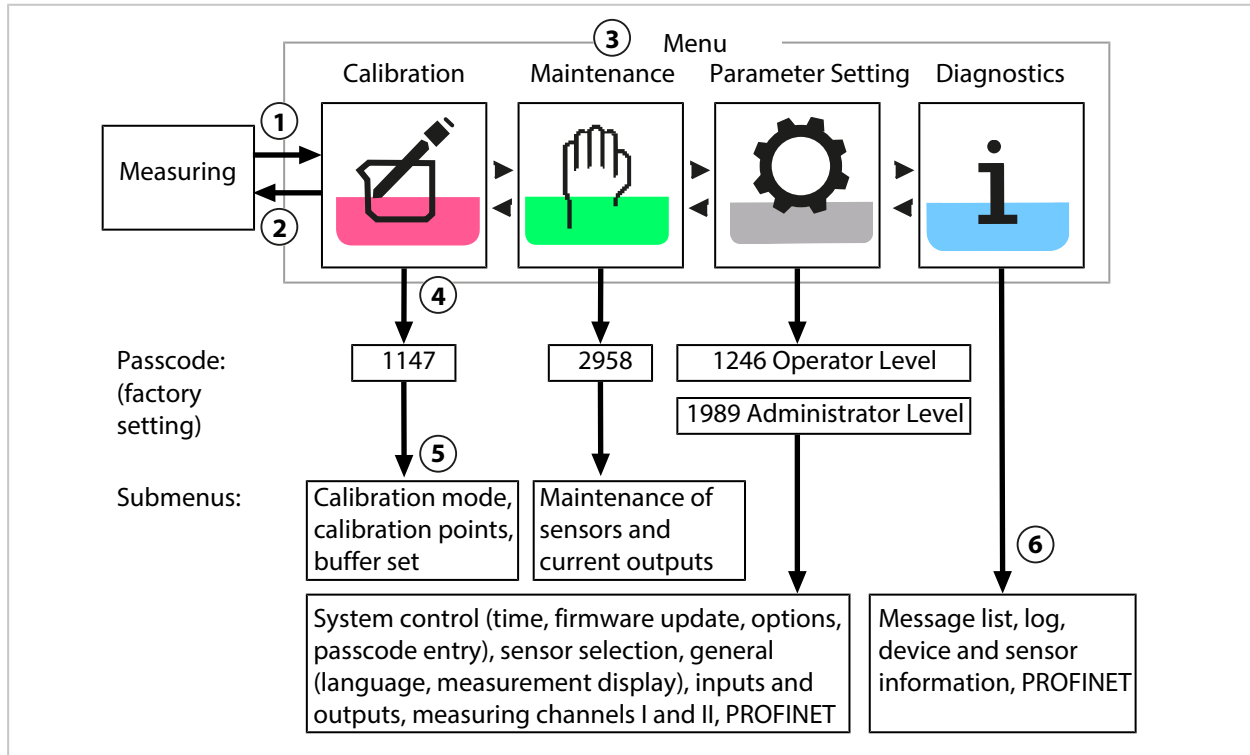

- | | |
|--|---|
| <p>1 Pressing the <i>left softkey: Menu</i> accesses the Menu Selection.</p> <p>2 Pressing the <i>right softkey: Back to Meas.</i> returns to measurement.</p> <p>3 Select a menu using the <i>arrow keys</i>.</p> | <p>4 Press <i>enter</i> to confirm, enter passcode.</p> <p>5 Further submenus and menu items are shown.</p> <p>6 Selected functions in the Diagnostics menu can also be accessed in measuring mode by pressing the <i>right softkey</i> (Favorites menu).</p> |
|--|---|

5.5 Access Control

Access to the device functions is regulated and limited by individually adjustable passcodes. This prevents unauthorized modification of device settings or manipulation of the measurement results.















Passcodes are configured in **Parameter Setting** ▶ **System Control** → *System Control, p. 45*





5.6 Operating States

Function Check Mode (HOLD Function)

After activating parameter setting, calibration, or maintenance, the Stratos Multi enters function check mode (HOLD). PROFINET communication and the relay contacts/current outputs behave in accordance with the parameter settings. The state transmitted via PROFINET is in part dependent on the operating mode.

⚠ CAUTION! In function check (HOLD) mode, the current outputs may be frozen at the last measurement or set to a fixed value. Measurement operations must not be carried out while the device is in function check (HOLD) mode, as the system may behave unexpectedly and put users at risk.

Operating mode	Current outputs	Contacts ¹⁾	Timeout ²⁾
Measurement			-
Diagnostics			-
Calibration ³⁾			-
Maintenance ³⁾			
Sensor monitor			-
Current source			-
Parameter setting ³⁾			20 min
Rinse function ³⁾		 ⁴⁾	At end of rinse time

	Active (output functions normally)		Manual control of the outputs
	Last value or fixed default value		Depending on parameter setting

5.7 Measurement Display

The following settings are possible:

2, 4, 6, or 8 values without measuring channel selection	Any display of measured values from the measuring channels and the device possible
2 or 4 values with measuring channel selection	Any display of measured values from the measuring channels

Settings can be changed in the **Measurement Display** submenu:

Parameter Setting ▶ **General** ▶ **Measurement Display**

An overview of display options can be found in the Parameter Setting chapter.

→ *Parameter Setting, General, p. 51*

The **right softkey: Back to Meas.** returns you to measurements from any menu level. You may have to confirm that the system is ready for measurement.

If required, the display can be configured to switch off after not having been used for a user-defined period of time.

This setting can be changed in the **Display** submenu:

Parameter Setting ▶ **General** ▶ **Display**

Display auto-off can be configured as follows:

- No auto-off
- After 5 minutes
- After 30 minutes

¹⁾ The relay contacts are only available in PROFINET mode. Analog current outputs and relay contacts cannot be used at the same time.

²⁾ "Timeout" means that the device will return to measuring mode after 20 minutes without key activity.

³⁾ Function check (HOLD) is active.

⁴⁾ Rinse contact is active.

6 Parameter Setting

⚠ CAUTION! Incorrect parameter settings or adjustments can result in incorrect outputs. A system specialist must therefore commission Stratos Multi, set all its parameters, make all necessary adjustments, and protect it from unauthorized modifications.

Note: PROFINET configuration → *PROFINET*, p. 104

Opening Parameter Setting

Left softkey: Menu Menu Selection ▶ Parameter Setting

01. From within measuring mode, press the **left softkey: Menu**.

✓ The Menu Selection opens.

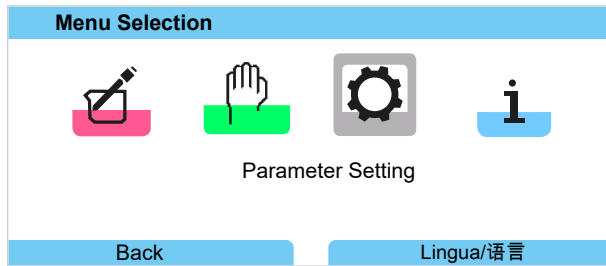

02. Using the right **arrow key**, select the Parameter Setting menu and confirm with **enter**.

03. Select the relevant operating level and enter any required passcode. → *Operating Levels*, p. 43

✓ The Parameter Setting menu contains items for things such as inputs and outputs, sensor selection I and II, system control, and general parameter setting. Parameter setting is automatically ended 20 minutes after the last registered keystroke, after which Stratos Multi returns to measuring mode (timeout).

Note: Function check (HOLD) is active. PROFINET communication and the relay contacts/current outputs behave in accordance with the parameter settings. Return to measuring mode to exit the function check, e.g., with the **right softkey: Back to Meas.**

6.1 Operating Levels

There are three access levels in the Parameter Setting menu:

- Viewing level (all data)
- Operator level (operation data)
- Administrator level (all data)

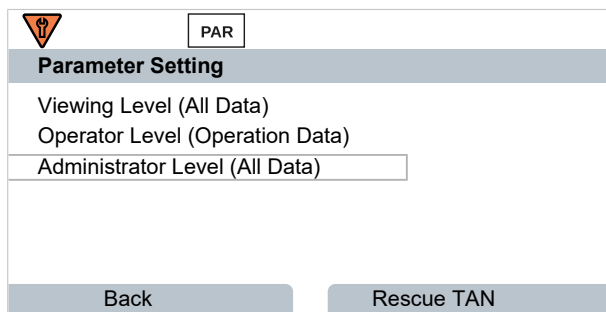

Viewing Level

- Display of all settings
- Settings cannot be changed in the Viewing level.

Operator Level

- Access to all functions that have been enabled at the Administrator level.
- Locked functions are displayed in gray and cannot be edited.

Administrator Level

- Access to all settings, including passcode settings. → *Passcode Entry, p. 50*
- Releasing or blocking functions for access from the operator level. Functions that can be locked for the Operator level are marked with the “lock” icon. → *Locking a Function, p. 44*

Note: For reasons of clarity, the step to “Select the relevant operating level and enter any required passcode” is omitted in the parameter setting description set out in this document. Parameter setting is generally carried out at Administrator level.

6.2 Locking a Function

Example: Locking access to the configuration of relay contact K1 from the Operator level

01. Open **Parameter Setting**.
02. Select **Administrator Level**.
03. Enter passcode (factory setting: 1989).
04. Select submenu:

Inputs/Outputs ▶ Relay Contacts ▶ Contact K1

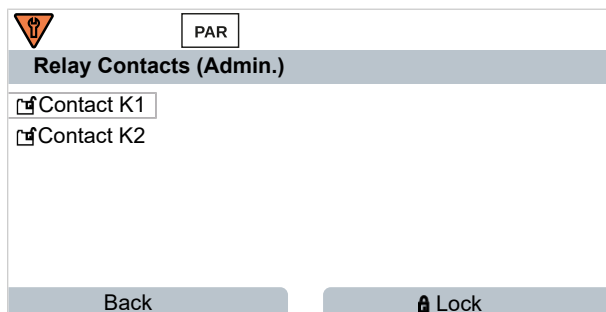

05. **Right softkey: Lock**

✓ The **Contact 1** submenu is now marked with the “lock” icon. This function can no longer be accessed from the Operator level.

The **softkey** function automatically changes to **Unlock**.

✓ At the Operator level, the locked function is shown in gray.

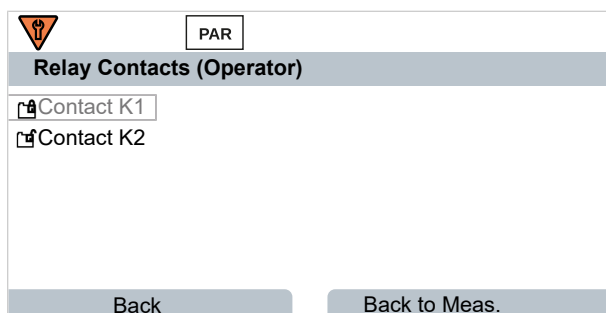

6.3 Parameter Setting Menus

Menu	Description
System Control	→ <i>System Control</i> , p. 45
General	→ <i>Parameter Setting, General</i> , p. 51
Inputs/Outputs	→ <i>Inputs and Outputs</i> , p. 57
Sensor Selection [I] [II]	→ <i>Sensor Selection [I] [II]</i> , p. 66
[I] [Sensor]	Channel I parameter setting: Menu based on sensor selection.
[II] [Sensor]	Channel II parameter setting: Menu based on sensor selection.
PROFINET	→ <i>PROFINET</i> , p. 104

6.4 System Control

Submenu	Description
Memory Card	This menu item is shown if a Data Card is inserted: Settings for logbook and measurement recorder data recording. The memory card can be formatted. → <i>Memory Card</i> , p. 46
Transfer Configuration	If a Data Card is inserted, the measuring device's configuration can be saved and transferred to another measuring device. → <i>Transfer Configuration</i> , p. 46
Parameter Sets	Two parameter sets (A, B) are available in the device. If a Data Card is inserted, up to five parameter sets can be saved on or loaded from the Data Card. → <i>Parameter Sets</i> , p. 47
Function Control	Allocation of functions for activation by softkey or optocoupler input OK1. → <i>Function Control</i> , p. 48
Calculation Blocks	TAN option FW-E020: Convert available process variables to new variables. → <i>Calculation Blocks (FW-E020)</i> , p. 244.
Time/Date	Define date and time format; input of date, time, and weekday. → <i>Time/Date</i> , p. 48
Meas. Point Description	Free input of a tag number and notes; can be retrieved in the Diagnostics menu. → <i>Measuring Point Description</i> , p. 48
Firmware Update	This menu item is shown if a FW Update Card is inserted. TAN option FW-E106: Firmware update with FW Update Card. → <i>Firmware Update (FW-E106)</i> , p. 252
Option Activation	Activation of add-on options via TAN. The TAN is only valid for the Stratos Multi with the associated serial number. → <i>Option Activation</i> , p. 49
Logbook	Select events to be logged (failure/maintenance required); can be retrieved in the Diagnostics menu. → <i>Logbook</i> , p. 49
Buffer Table	TAN option FW-E002: Specification of a buffer set. → <i>pH Buffer Table: Entry of Individual Buffer Set (FW-E002)</i> , p. 235
Concentration Table	TAN option FW-E009: Specification of a concentration solution for conductivity measurement. → <i>Concentration Determination (FW-E009)</i> , p. 237
Restore Factory Settings	Restore all parameters to factory settings. → <i>Restore Factory Settings</i> , p. 50
Passcode Entry	Change passcodes. → <i>Passcode Entry</i> , p. 50

6.4.1 Memory Card

This menu is displayed if the ZU1080-S-*-D Data Card is inserted.

With activated TAN option FW-E104 logbook: Enable/disable recording of logbook entries on the Data Card. → *Logbook*, p. 49

With activated TAN option FW-E103 measurement recorder: Enable/disable recording of measurement recorder entries on the Data Card. → *Measurement Recorder (FW-E103)*, p. 250

The decimal separator can be set as a point or comma.

The Data Card can be formatted, in which case all saved entries are deleted.

See also

→ *Memory Card*, p. 182

6.4.2 Transfer Configuration

All device settings can be saved on a memory card (ZU1080-S-*-D Data Card): → *Memory Card*, p. 182

Parameter Setting ▶ System Control ▶ Transfer Configuration

Note: The inserted Data Card is shown on the display.

- Select **Save Configuration** to write all the device settings (except passcodes) to the Data Card.
Backup file generated on the Data Card:
param/config.par
- Select **Load Configuration** to read all the device settings from the Data Card and apply them to the device.

Transferring all Device Settings from One Device to Other Devices

Requirements

- The devices all feature identical hardware.
- TAN options (add-on functions):
All required TAN options must be enabled before they can be transferred.

Steps

01. Parameter Setting ▶ System Control ▶ Transfer Configuration
02. Menu item **Configuration**: Save
03. Start the transfer with the **right softkey**: *Execute*.
✓ The device settings are saved to the Data Card.
04. Switch to the Maintenance ▶ Open/Close Memory Card menu.
05. Terminate access to the memory card using the **right softkey**: *Close*.
06. Remove the Data Card.
✓ You can transfer the device settings to other, identically equipped devices.
07. Insert the Data Card containing the device settings in the next device to be configured.
08. Parameter Setting ▶ System Control ▶ Transfer Configuration
09. Menu item **Configuration**: Load
10. Start the transfer with the **right softkey**: *Execute*.
✓ The device settings are read from the Data Card and applied.
11. Switch to the Maintenance ▶ Open/Close Memory Card menu.
12. Terminate access to the memory card using the **right softkey**: *Close*.
13. Remove the Data Card.

6.4.3 Parameter Sets

Stratos Multi provides two complete selectable parameter sets (A/B) for different measuring tasks. The currently activated set can be signaled by a relay contact. → *Relay Contacts, p. 60*

Parameter set "B" only permits setting of process-related parameters.

Parameter Setting ▶ System Control ▶ Parameter Sets

Save Parameter Set

The active parameter set is transferred to the Data Card.

Note: The parameter set saved on the Data Card is overwritten.

Load Parameter Set

A parameter set stored on the Data Card is transferred to the device.

Note: This overwrites the current parameter set in the device.

Up to five parameter sets can be stored on the Data Card with TAN option FW-E102.

→ *Parameter Sets 1-5 (FW-E102), p. 249*

Selecting Parameter Sets A/B

Note: Switching parameter sets only works locally on the device, not via PROFINET.

The control element for switching between parameter sets (optocoupler input OK1 or softkey) is selected in:

Parameter Setting ▶ System Control ▶ Function Control

The currently active parameter set is indicated by the  or  icons.

Selection via a signal at optocoupler input OK1:

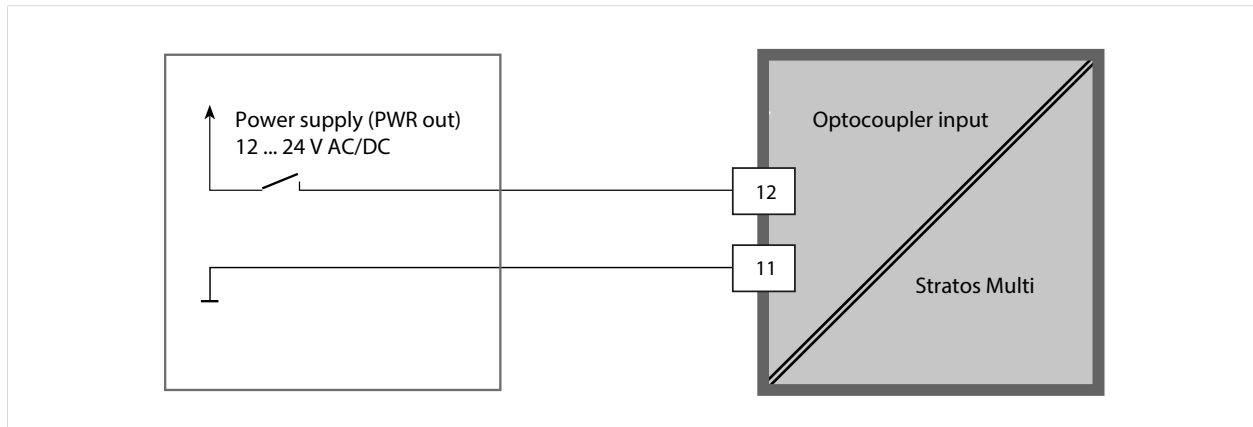

0 ... 2 V AC/DC: Parameter set A active

10 ... 30 V AC/DC: Parameter set B active

Note: The selection has no effect when using parameter sets from a memory card. Switching between parameter sets A and B is possible if they are saved in the device.

6.4.4 Function Control

The following functions can be activated by softkey or optocoupler input OK1:

Input OK1:

- Parameter set selection
- Flow
- Function check
- Function check (channel)

Right softkey:

- Off
- Value rotation
- Parameter set selection
- Favorites menu

The selection can be changed in the **Function Control** submenu:

Parameter Setting ▶ System Control ▶ Function Control

6.4.5 Calculation Blocks (TAN Option FW-E020)

Calculation blocks convert existing process variables to new variables.

The menu is only shown if the TAN option is activated. → *Calculation Blocks (FW-E020), p. 244*

Parameter Setting ▶ System Control ▶ Calculation Blocks

6.4.6 Time/Date

The time and date in the installed real-time clock are required for:

- Controlling calibration and cleaning cycles
- Displaying the time on the display
- Assigning times to the calibration data in the sensor head on digital sensors
- Diagnostic functions; logbook entries are given a time stamp, for example

Note: No automatic switchover from winter to summer time.

Settings can be changed in the **Time/Date** submenu:

Parameter Setting ▶ System Control ▶ Time/Date

6.4.7 Measuring Point Description

You can enter a measuring point and notes (e.g., date of last maintenance).

Parameter Setting ▶ System Control ▶ Meas. Point Description

- Select position: **Left/right arrow keys**
- Select characters A-Z 0-9 _ # * + - / : < = > Space: **Up/down arrow keys**

Display of the measuring point description in the **Diagnostics** menu

→ *Measuring Point Description, p. 156*

6.4.8 Firmware Update (TAN Option FW-E106)

The firmware update is carried out using TAN option FW-E106 and an FW Update Card.

→ *Firmware Update (FW-E106), p. 252*

The menu is only shown if the TAN option is activated and the FW Update Card has been inserted.

Parameter Setting ▶ System Control ▶ Firmware Update

6.4.9 Option Activation

Add-on functions (TAN options) expand the device's capabilities. The TAN options are device-specific. When ordering a TAN option, you must therefore specify the serial number of the device in addition to the relevant order code for this function. The manufacturer then supplies a TAN (transaction number) to activate the add-on function. This TAN is only valid for the device with the stated serial number.

You can find your device's serial number in:

[Diagnostics](#) ▶ [Device Information](#)

Overview of TAN options → *Product Range and Options, p. 12*

Description of TAN options → *Annex, p. 202*

Activate TAN Option

01. [Parameter Setting](#) ▶ [System Control](#) ▶ [Option Activation](#)

02. Select the option to be enabled.

03. Set to "Active" using the **arrow keys**.

✓ Enter the TAN at the prompt. The current serial number is shown.

04. Enter the TAN and confirm with OK.

✓ The option is available.

Note: An activated TAN option can be deactivated and reactivated without having to re-enter the TAN.

6.4.10 Logbook

The logbook records the last 100 events with date and time and displays them on the device.

In addition, when using the Data Card and TAN option FW-E104, 20,000 entries or more can be stored on the Data Card.

[Parameter Setting](#) ▶ [System Control](#) ▶ [Logbook](#)

- Select whether to log Failure and/or Maintenance Required messages in the logbook.
- Delete the logbook entries

Displaying the Logbook Entries

The entries can be viewed in the [Diagnostics](#) menu. → *Logbook, p. 154*

[Menu Selection](#) ▶ [Diagnostics](#) ▶ [Logbook](#)

6.4.11 Measurement Recorder (TAN Option FW-E103)

With TAN option FW-E103: Delete the data stored on the measurement recorder.

The menu is only shown if the TAN option is activated.

[Parameter Setting](#) ▶ [System Control](#) ▶ [Measurement Recorder](#)

See also

→ *Measurement Recorder (FW-E103), p. 250*

6.4.12 Buffer Table (TAN Option FW-E002)

The menu is only shown if the TAN option is activated.

Parameter Setting ▶ System Control ▶ Buffer Table

See also

→ *pH Buffer Table: Entry of Individual Buffer Set (FW-E002), p. 235*

6.4.13 Concentration Table (TAN Option FW-E009)

The menu is only shown if the TAN option is activated.

Parameter Setting ▶ System Control ▶ Concentration Table

See also

→ *Concentration Determination (FW-E009), p. 237*

6.4.14 Restore Factory Settings

Allows the parameters to be reset to their factory settings:

Parameter Setting ▶ System Control ▶ Restore Factory Settings

NOTICE! After confirming with “Yes,” all individual parameter settings are overwritten with the factory settings.

The reset function in the device menu does not reset the PROFINET network settings.

→ *Resetting the Device, p. 107*

6.4.15 Passcode Entry

Passcodes (factory setting)

Calibration	1147
Maintenance	2958
Operator Level	1246
Administrator Level	1989

The passcodes can be changed or deactivated in the **Passcode Entry** submenu:

Parameter Setting ▶ System Control ▶ Passcode Entry

Note: The passcode for the Administrator level cannot be deactivated.

Note: If you lose the administrator passcode, system access is locked! The manufacturer can generate a rescue TAN. If you have any questions, please contact Knick Elektronische Messgeräte GmbH & Co. KG using the information provided on the last page of this document.

6.5 Parameter Setting, General

Note: Function check (HOLD) is active.

Submenu	Description
Language	User interface language: German (factory setting), English, French, Italian, Spanish, Portuguese, Chinese, Korean, Swedish
Units/Formats	Temperature unit °C (factory setting) or °F. Other units and formats depending on the selected process variable, e.g., pressure in mbar, kPa, psi Display format pH xx.xx or xx.x
Measurement Display	Values to be displayed (up to 8) → <i>Configuring the Measurement Display, p. 51</i>
Display	Display color, brightness, and display auto-off (factory setting: None) → <i>Display, p. 56</i>
Measurement Recorder	TAN option FW-E103: Logging of measured and additional values → <i>Measurement Recorder (FW-E103), p. 250</i>

6.5.1 Configuring the Measurement Display

Parameter Setting ▶ General ▶ Measurement Display

- Set the **number** of values to be displayed:
2 values (1 channel), 2 values (2 channels), 4 values (2 channels),
2 values, 4 values, 6 values, 8 values
- As required, assign channels and variables to be displayed.
- Confirm with **enter**.

Measurement Display, Example with 2 Values

Selection	Result
Selection of any two variables:	

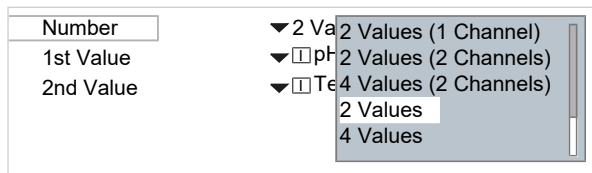

Select number of values.
Confirm with **enter**.

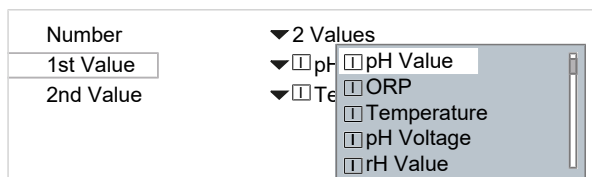

Select first variable.
Confirm with **enter**.

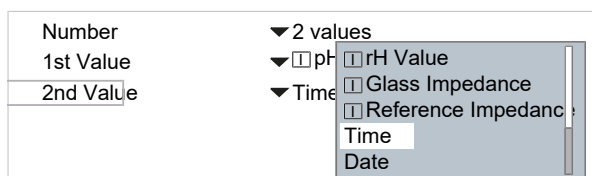

Select second variable.
Confirm with **enter**.
Set further parameters with the **left softkey: Back**.
End parameter setting with the **right softkey: Back to Meas**.

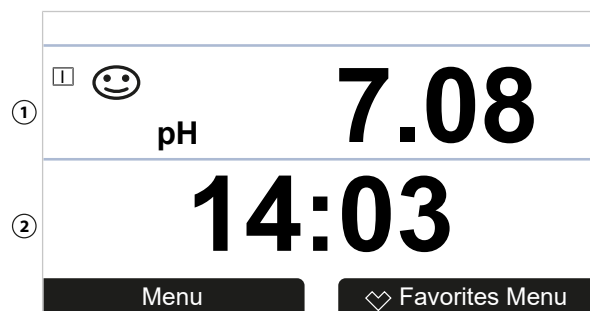

- (1) First value
- (2) Second value

Measurement Display, Example with 2 Values (1 Channel)

Selection	Result
-----------	--------

Select two variables in one measuring channel:

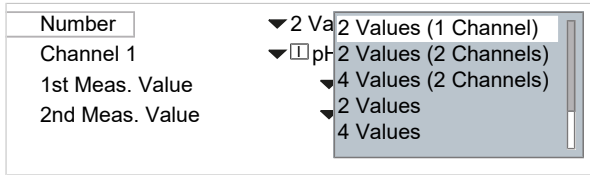

Select number of values and channels.
Confirm with **enter**.

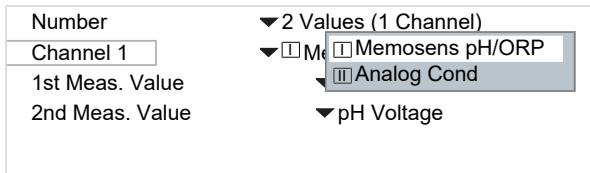

Assign a sensor to the channel.
Confirm with **enter**.

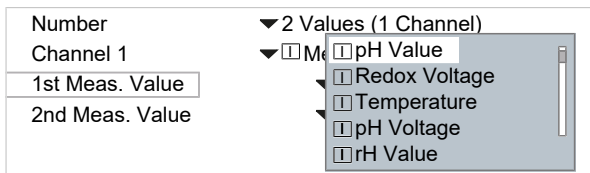

Select the first variable for channel I.
Confirm with **enter**.

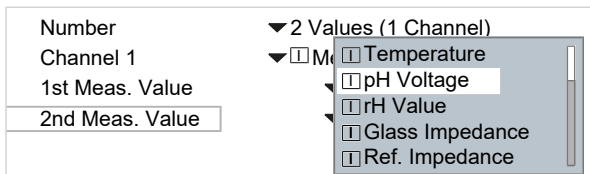

Select the second variable for channel I.
Confirm with **enter**.
Set further parameters with the **left softkey: Back**.
End parameter setting with the **right softkey: Back to Meas**.

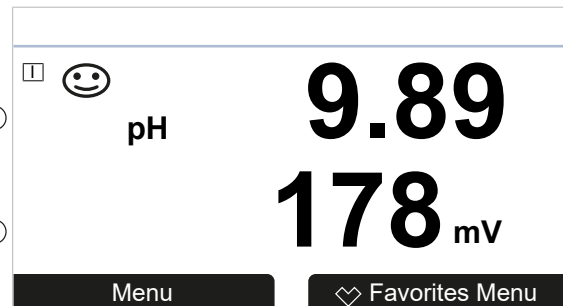

- (1) First value in channel I
- (2) Second value in channel I

Measurement Display, Example with 2 Values (2 Channels)

Selection	Result
-----------	--------

Select two variables in two measuring channels:

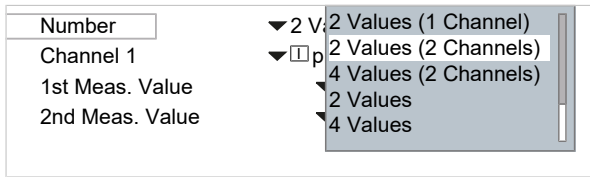

Select number of values and channels.
Confirm with **enter**.

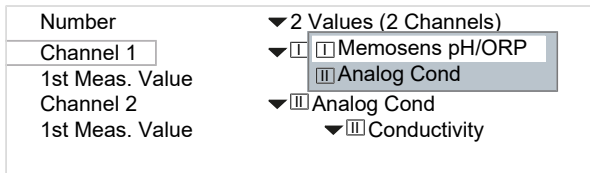

Assign a sensor to the first channel.
Confirm with **enter**.

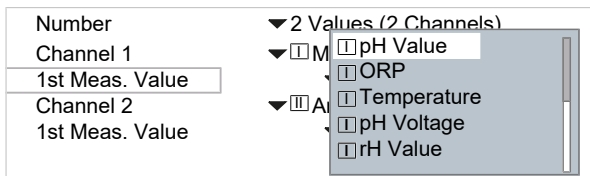

Select the variable for the first channel.
Confirm with **enter**.

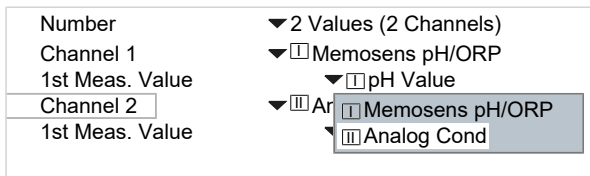

Assign a sensor to the second channel.
Confirm with **enter**.

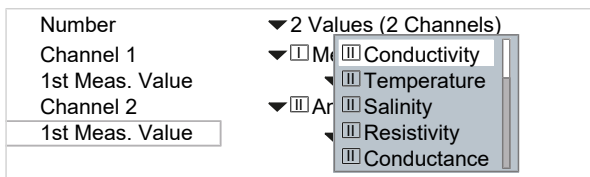

Select the variable for the second channel.
Confirm with **enter**.
Set further parameters with the **left softkey: Back**.
End parameter setting with the **right softkey: Back to Meas**.

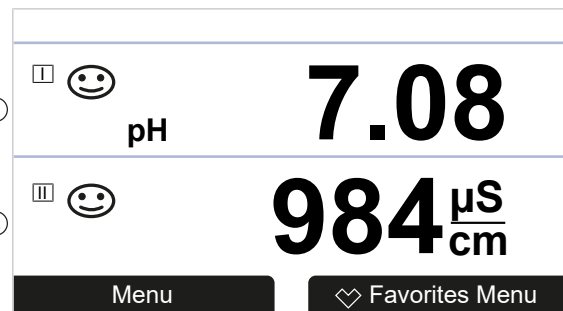

- (1) First value in channel I
- (2) Second value in channel II

Measurement Display, Example with 4 (6, 8) Values

Selection	Result
-----------	--------

Select any four (six, eight) variables

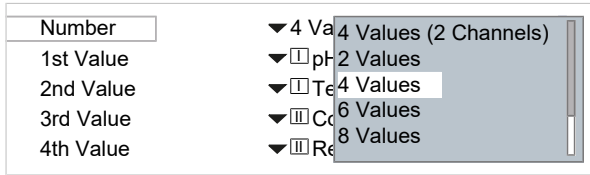

Select number of values.
Confirm with **enter**.

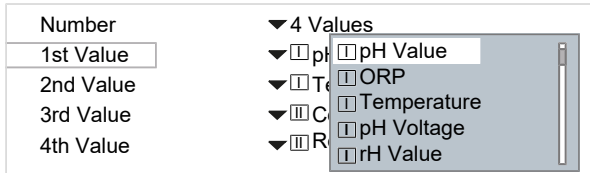

Select first variable.
Confirm with **enter**.

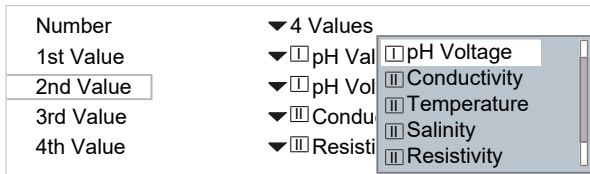

Select second variable.
Confirm with **enter**.

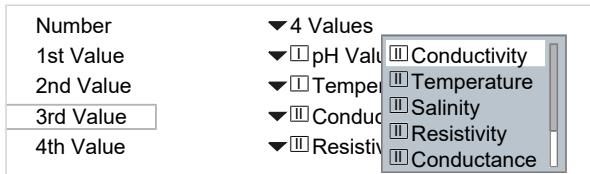

Select third variable.
Confirm with **enter**.

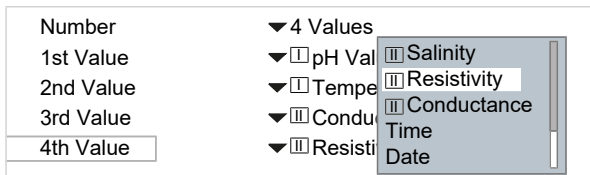

Select fourth variable.
Confirm with **enter**.
Set further parameters with the **left softkey: Back**.
End parameter setting with the **right softkey: Back to Meas**.

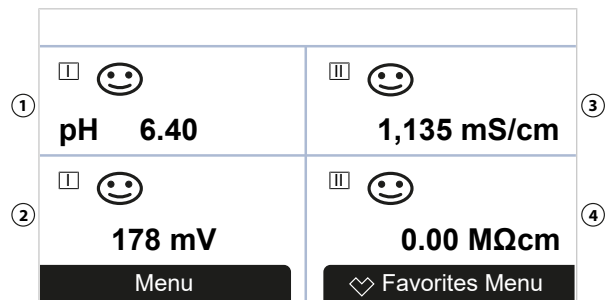

- (1) First value
- (2) Second value
- (3) Third value
- (4) Fourth value

Measurement Display, Example with 4 Values (2 Channels)

Selection	Result
-----------	--------

Select four variables in two measuring channels:

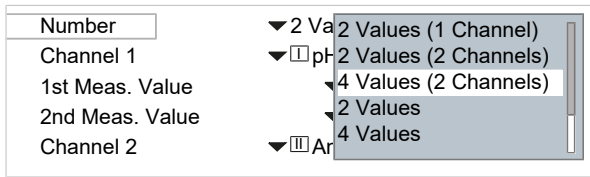

Select number of values and channels.
Confirm with **enter**.

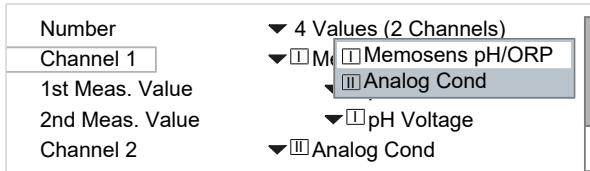

Assign a sensor to the first channel.
Confirm with **enter**.

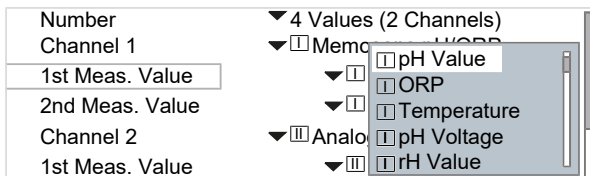

Select the first variable for the first channel.
Confirm with **enter**.

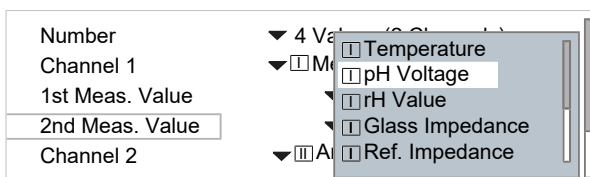

Select the second variable for the first channel.
Confirm with **enter**.

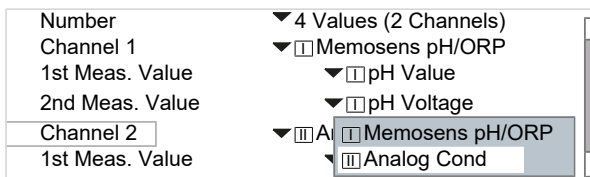

Assign a sensor to the second channel.
Confirm with **enter**.

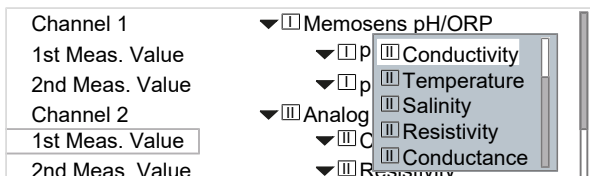

Select the first variable for the second channel.
Confirm with **enter**.

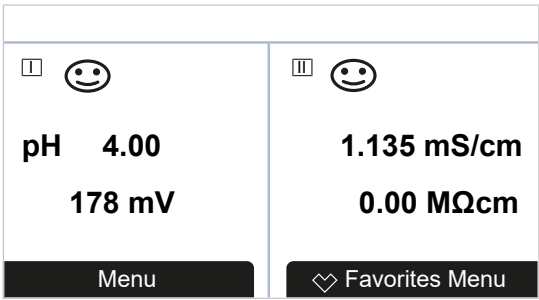
Selection	Result
<p>Channel 1 1st Meas. Value 2nd Meas. Value Channel 2 1st Meas. Value 2nd Meas. Value</p> <p>▼ [I] Memosense pH/ORP ▼ [I] pH [II] Conductivity ▼ [I] pH [II] Temperature ▼ [II] Analog [II] Salinity ▼ [II] C [II] Resistivity ▼ [II] Resistivity</p>	
<p>Select the second variable for the second channel. Confirm with enter. Set further parameters with the left softkey: Back. End parameter setting with the right softkey: Back to Meas.</p>	<p>(1) First value in channel I (2) Second value in channel I (3) First value in channel II (4) Second value in channel II</p>

6.5.2 Display

It is possible to change the display's color and brightness.

The following settings are possible:

Display Color	White, NE107 (factory setting): If a NAMUR message is available for a measured value, the measured value is backlit in accordance with the NAMUR color. Limits at which a message is generated can be defined for the "Failure" and "Out of Specification" messages. Parameter Setting ▶ [I] [II] [Sensor] ▶ Messages ▶ Messages [Process Variable] ▶ Monitoring
Brightness	Factory setting: 80 %
Auto-off	None (factory setting), after 5 min, after 30 min

Settings can be changed in the [Display](#) submenu:

[Parameter Setting](#) ▶ [General](#) ▶ [Display](#)

Note on Display Auto-off

The display switches off 5 or 30 minutes after the last keystroke is registered. Press any key to switch the display back on.

6.5.3 Measurement Recorder (TAN Option FW-E103)

The measurement recorder logs measured values and additional values depending on its parameter setting. The last 100 entries are graphically presented on the display of the Stratos Multi.

The menu is only shown if the TAN option is activated.

[Parameter Setting](#) ▶ [General](#) ▶ [Measurement Recorder](#)

See also

→ *Measurement Recorder (FW-E103), p. 250*

6.6 Inputs and Outputs

The following inputs and outputs are available:

- Two current outputs ¹⁾ 0/4 ... 20 mA for transmitting variables such as measured value or temperature (factory setting); active or passive configuration possible → *Current Outputs, p. 57*
- Two freely configurable floating switching outputs ²⁾ → *Relay Contacts, p. 60*
- One digital control input OK1 → *Control Inputs, p. 65*

6.6.1 Current Outputs

The current outputs are deactivated ex works.

The current outputs cannot be enabled in PROFINET mode.

Adjustable Parameters for the Current Outputs

Usage	On, Off						
Process Variable	Selection from all available process variables						
Current Range	4 ... 20 mA or 0 ... 20 mA						
Characteristic	Linear Trilinear (input of additional vertex points required) Function (input of a 50 % point required) Logarithmic Table (with TAN option FW-E006 "current characteristic") → <i>Current Characteristic (FW-E006), p. 237</i>						
Output	Output current range 4 ... 20 mA or 0 ... 20 mA						
Start 0(4) mA	Start of span						
End 20 mA	End of span						
Output Filter	To smooth the current output, a low-pass filter with adjustable filter time constant can be switched on. The filter acts on the current output only.						
Function Check	Current output response in Function Check mode: <table border="1" data-bbox="475 1189 1422 1305"> <tr> <td>Current Meas.</td> <td>The currently measured value appears at the current output.</td> </tr> <tr> <td>Last Usable Value</td> <td>The last measured value is held at the current output.</td> </tr> <tr> <td>Fixed Value</td> <td>The current output supplies a fixed value of 0 ... 22 mA.</td> </tr> </table>	Current Meas.	The currently measured value appears at the current output.	Last Usable Value	The last measured value is held at the current output.	Fixed Value	The current output supplies a fixed value of 0 ... 22 mA.
Current Meas.	The currently measured value appears at the current output.						
Last Usable Value	The last measured value is held at the current output.						
Fixed Value	The current output supplies a fixed value of 0 ... 22 mA.						
Behavior During Messages	Failure Current output response in the event of a failure message: Off, 3.6 mA, 22 mA Delay Input of a delay of 0 ... 600 s in the event of a failure message.						

¹⁾ Not if PROFINET communication is enabled

²⁾ Only if PROFINET communication is enabled

Settings can be changed in the **Current Outputs** submenu:

Parameter Setting ▶ **Inputs/Outputs** ▶ **Current Outputs**

Setting the Span: Start (0/4 mA) and End (20 mA)

Example span pH 0 ... 14

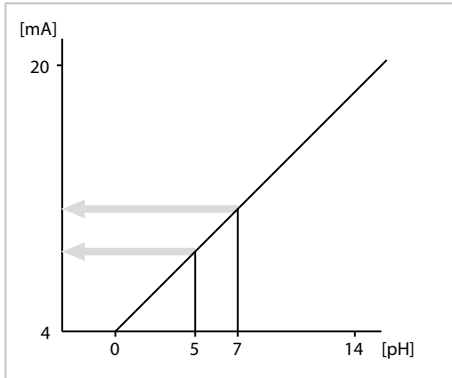

Example span pH 5 ... 7

Advantage: Higher resolution in range of interest

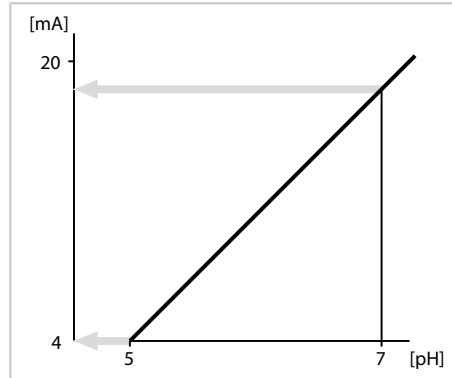

Characteristic Curves

Linear Characteristic

The process variable is represented by a linear output current curve.

Output 4 ... 20 mA, span pH 0 ... 14

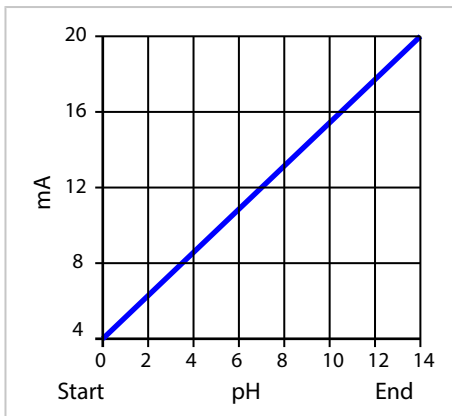

Output 4 ... 20 mA, span pH 5 ... 9

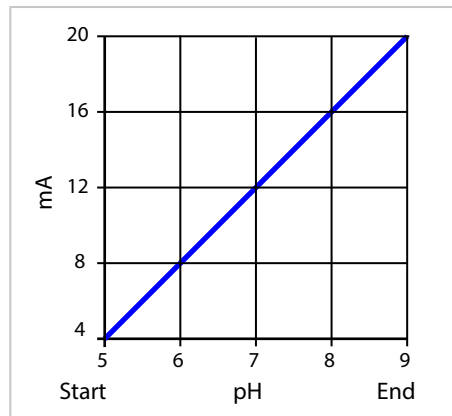

Trilinear/Bilinear Curve

Requires the input of two additional vertex points.

Trilinear: Vertex points **(1)** and **(2)** are different values.

Bilinear: Vertex points **(1)** and **(2)** are the same values.

Output 4 ... 20 mA, span pH 0 ... 14

Output 4 ... 20 mA, span pH 5 ... 9

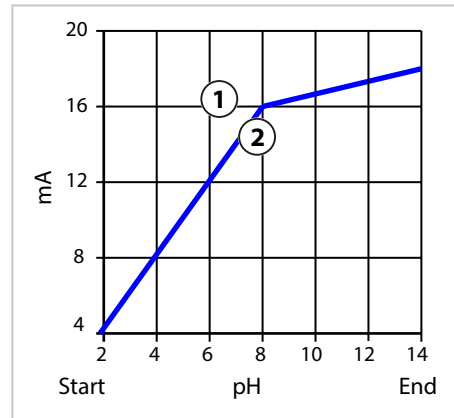
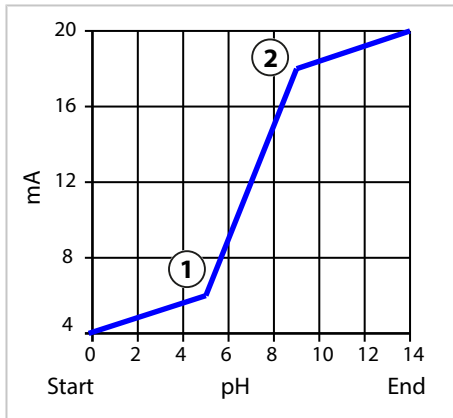

Function/Logarithmic Curve

Nonlinear output current characteristic: allows measurements over several decades, e.g., measuring very low values with a high resolution and high values with a low resolution. Requires the input of the value for 50 % output current.

Characteristic: Function with input of 50 % value **(1)**

Characteristic: Logarithmic

Output 4 ... 20 mA, span 1 ... 100 $\mu\text{S/cm}$

Output 4 ... 20 mA, span 1 ... 1000 $\mu\text{S/cm}$

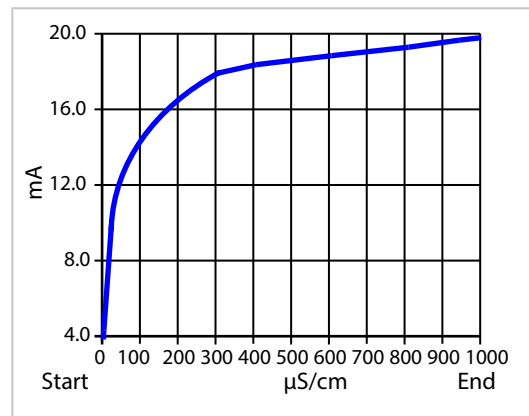
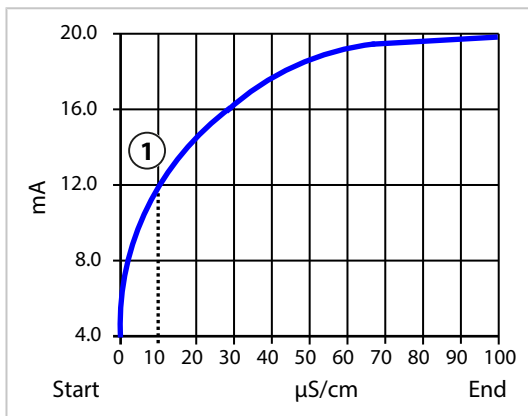

Output Filter Time Interval

To smooth the current output, a low-pass filter with adjustable time interval can be switched on. When there is a jump at the input (100 %), the output level is at 63 % after the time interval has been reached. The time interval can be set from 0 to 120 sec. If the time interval is set to 0 sec, the current output follows the input.

Note: The filter acts only on the current output, not on the display or the limit values.

Current During Function Check (HOLD)

Depending on the parameter setting, the current outputs switch to one of the following states:

- Current measurement
- Last measured value (factory setting)
- Fixed value

Message when the Current Range is Exceeded

As delivered, the "Failure" message is generated when the output current range is exceeded (< 3.8 mA or > 20.5 mA). This setting can be changed in the parameter settings for the respective measuring channel in the **Messages** menu:

Parameter Setting ▶ [I] [II] [Sensor] ▶ Messages

6.6.2 Relay Contacts

Up to two free relay contacts K1, K2 can be configured. The relay contacts are only available if PROFINET communication is enabled.

Notes on wiring → *Relay Contacts: Protective Wiring, p. 29*

Use of Relay Contacts

The following uses are possible:

- Off
- Failure
- Maintenance required
- Out of specification
- Function check
- Limit
- Rinse contact
- Rinse contact (channel) (if using two channels)
- Parameter set B active
- USP output (with conductivity sensor only)
- Sensoface
- Sensoface (channel) (if using two channels)
- DO 1 / DO 2

The switching behavior can be adjusted (normally open or normally closed contact).

- N/O/normally open/make contact: the relay contact closes when it is activated.
- N/C/normally closed/break contact: the relay opens when it is activated.

ON/OFF delays can also be configured.

Settings can be changed in the **Relay Contacts** submenu:

Parameter Setting ▶ Inputs/Outputs ▶ Relay Contacts

Usage: Failure

01. Inputs/Outputs ▶ Relay Contacts .
02. Select the desired contact with the *up/down arrow keys* and *enter*.
03. Usage : Failure
04. Set the contact parameters.

 Failure is active

- if a value has exceeded or fallen below "Failure Limit Hi" or "Failure Limit Lo" respectively
- if the device's measuring range limits are exceeded
- in the event of other failure messages

That means that the equipment no longer operates properly or that process parameters have reached a critical value.

The relay contact is not activated for "Function Check" (HOLD).

Usage: Maintenance Required

01. Inputs/Outputs ▶ Relay Contacts .
02. Select the desired contact with the *up/down arrow keys* and *enter*.
03. Usage : Maintenance required
04. Set the contact parameters.

 Maintenance required is active if messages appear that require maintenance. That means that the equipment is still operating properly but should be serviced, or that process parameters have reached a value requiring intervention. Typical example: The meter detected a worn sensor.

The relay contact is not activated for "Function Check" (HOLD).

Usage: Out of Specification

01. Inputs/Outputs ▶ Relay Contacts .
02. Select the desired contact with the *up/down arrow keys* and *enter*.
03. Usage : Out of specification
04. Set the contact parameters.

 Out of specification is active

- if a value has exceeded or fallen below "Out of Specification Hi" or "Out of Specification Lo" respectively
- if the device has detected deviations from the permissible ambient or process conditions
- if faults are present indicating that the measurement uncertainty is probably greater than to be expected under normal operating conditions

The relay contact is not activated for "Function Check" (HOLD).

Usage: Function Check

01. Inputs/Outputs ▶ Relay Contacts .
02. Select the desired contact with the *up/down arrow keys* and *enter*.
03. Usage : Function check
04. Set the contact parameters.



Function check (HOLD) is active:

- during calibration (only the corresponding channel)
- during maintenance (current source, relay test)
- during parameter setting at the operator level or the administrator level
- during an automatic rinse cycle.

The current outputs respond as configured:

Parameter Setting ▶ Inputs/Outputs ▶ Current Outputs ▶ Function Check

The measurement display is shown with orange backlighting:

Parameter Setting ▶ General ▶ Display ▶ Display Color : NE107 (Factory Setting)

Usage: Limit

01. Inputs/Outputs ▶ Relay Contacts .
02. Select the desired contact with the *up/down arrow keys* and *enter*.
03. Usage : Limit
04. Set the contact parameters.

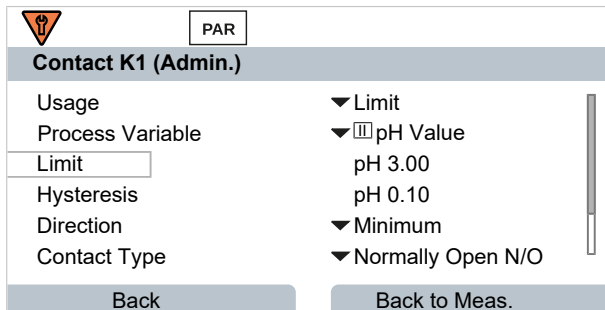

The hysteresis prevents small fluctuations in the measured value around the limit from constantly triggering a switching operation.

The hysteresis is configurable and can be activated with an ON/OFF delay time.

In the measurement display, an icon is used to indicate if the limit has been exceeded.

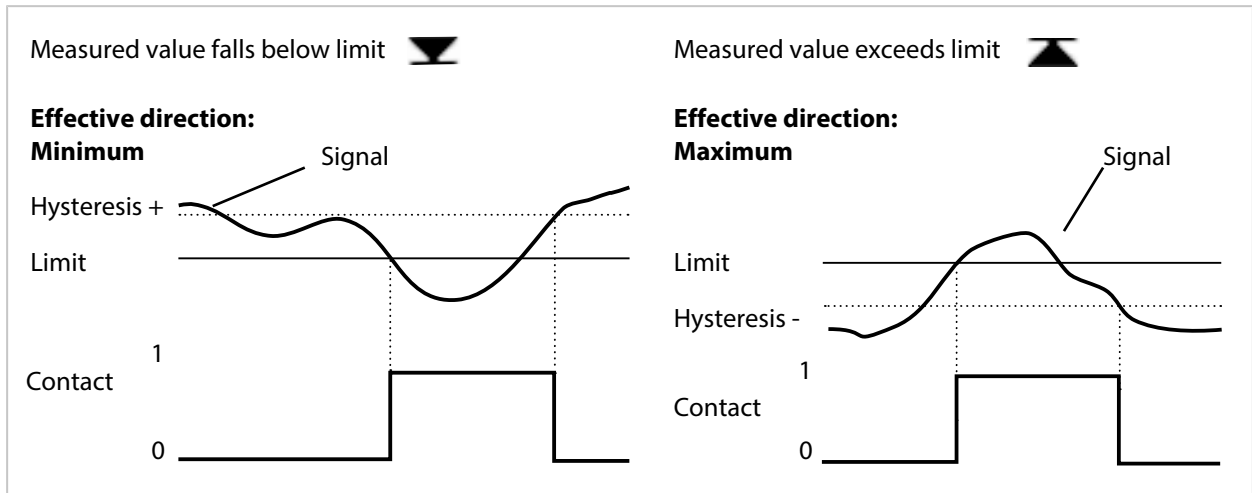

Usage: Rinse Contact

Notes for Configuration of the “Rinse Contact” Function

- The “function check” (HOLD) mode (e.g., during parameter setting) delays the execution of the “rinse contact” function.
- Up to 3 rinse functions (contacts K1 ... K3) can be configured independently of each other.
- The individual rinse functions are not synchronized with each other.

Time Response

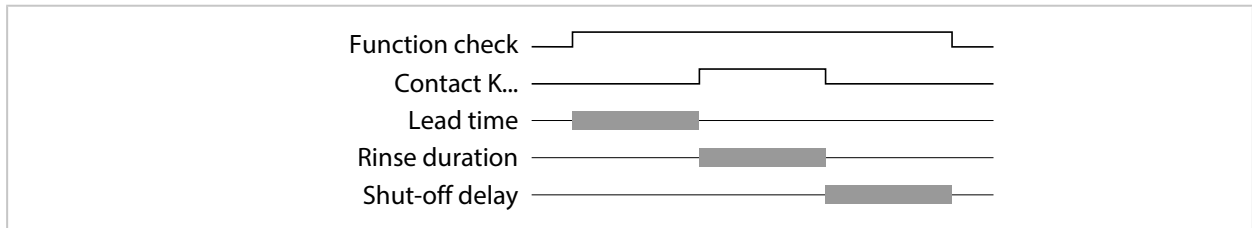

Configuring the Rinse Contact

01. **Inputs/Outputs** ▶ **Relay Contacts** .
02. Select the desired contact with the *up/down arrow keys* and *enter*.
03. **Usage** : Rinse contact
04. Select **Contact Type** (e.g., “N/O”).
05. Specify **Rinsing Interval** .
06. Specify **Rinse Duration** .
07. Specify **Rinse/Meas. Lead Time** .

Note: Function check (HOLD) is active during the defined “Lead Time...”

08. **Logbook Entry** : Off/on

Usage: USP Output

Can be activated when using a conductivity sensor and the USP function → *USP Function, p. 85*

01. Inputs/Outputs ▶ Relay Contacts .
02. Select the desired contact with the *up/down arrow keys* and *enter*.
03. Usage : USP output
04. Assign USP channel .
05. Set the contact parameters.

Usage: Sensoface

Sensoface messages can be output via a relay contact.

If using two sensors, the Sensoface messages can be assigned to different contacts:

01. Inputs/Outputs ▶ Relay Contacts .
02. Select the desired contact with the *up/down arrow keys* and *enter*.
03. Usage : Sensoface Channel
04. Select Channel .

PAR	
Contact K1 (Admin.)	
Usage	▼ Sensoface Channel
Channel	▼ Mem [I] Memosens pH
Contact Type	▼ N/O [II] Memosens Cond
ON Delay	0 s
OFF Delay	0 s
Back	

05. Set the contact parameters.

Usage: DO 1 / DO 2

If PROFINET communication is enabled, DO 1 can be assigned to relay contact K1 (REL 1), DO 2 to relay contact K2 (REL 2).

01. Inputs/Outputs ▶ Relay Contacts .
02. Select the desired contact with the *up/down arrow keys* and *enter*.
03. Usage : DO 1 / DO 2
04. Set the contact parameters.

6.6.3 Control Inputs

Stratos Multi features a digital optocoupler input OK2.

The following functions (depending on the parameter setting) can be started via the control signals:

Input OK1 : off, parameter set selection, flow, function check total, or function check channel

- The function of optocoupler input OK1 is defined in the System Control :

Parameter Setting ▶ System Control ▶ Function Control → *Function Control, p. 48*

The switching level for the control signal must be specified:

Parameter Setting ▶ Inputs/Outputs ▶ Control Inputs ▶ Inputs OK...

Input Level : Active 10 ... 30 V or active < 2 V

6.7 Sensor Selection [I] [II]

Note: Function check (HOLD) is active.

Stratos Multi is factory-set to a pH value measurement with Memosens sensor. This measuring function is also provided by the ORP measurement. The measuring function can be changed to measure conductivity or oxygen in the **Parameter Setting** menu:

To prepare Stratos Multi for measurements, the operating mode of the used measuring channel must be set:

Parameter Setting ▶ **Sensor Selection [I] [II]**

Sensor Selection [I] (measuring channel I): Memosens sensor or SE740 optical oxygen sensor (LDO)

Sensor Selection [II] (measuring channel II): Second Memosens sensor, analog sensor, or ISM sensor (TAN option FW-E053) via measuring module

Automatic Process Variable Detection

If Memosens sensors are connected directly, the process variable can be set to "Auto". In this case, the sensor is automatically detected by the device, which sets itself to the correct process variable. This does not apply to the MK-MS095N Memosens module.

NOTICE! Parameters that are dependent on process variables (e.g., measurement display, current outputs, contacts, ...) are set separately; this step is not automatic.

If "Auto" is not used with a Memosens sensor, and in general when using analog sensors, the operating mode must be set to the used sensor. The parameters that are dependent on process variables can then be set when a sensor is not connected.

Power Out

The output voltage of terminal 6 is selected in the **Power Out** menu item: 3,1 V, 14 V, 24 V. This output voltage is used to supply power to special sensors or external transmitters. The voltage at terminal 6 is automatically adjusted when using the SE740 optical oxygen sensor. The menu item is then not available.

Identifying a Memosens Sensor

A connected Memosens sensor is displayed as follows: sensor name, manufacturer, serial number, date of last adjustment

All relevant and typical sensor parameters are automatically transferred to the Stratos Multi.

6.8 pH Process Variable

Note: Function check (HOLD) is active.

Note: After changing the process variable or measuring mode, Stratos Multi retains its settings but needs to be reconfigured.

Selecting a Memosens pH Sensor

Parameter Setting ▶ Sensor Selection [I] [II] ▶ Sensor Selection [I]

Selection of the Memosens pH sensor connected to the RS-485 interface (terminals 1 ... 5):

Process variable: Auto or pH
 Mode: Memosens
 Functionality: pH, ISFET, or pH/ORP (depending on sensor type)

Selecting a Second Memosens pH Sensor

Parameter Setting ▶ Sensor Selection [I] [II] ▶ Sensor Selection [II]

Selection of a second Memosens pH sensor connected to the MK-MS095N measuring module:

Module: MK-MS
 Process variable: pH
 Mode: Memosens
 Functionality: pH, ISFET, or pH/ORP (depending on sensor type)

Adjustable Parameters for Memosens pH Sensors Parameter Setting ▶ [I] [II] Memosens pH

Input Filter	Pulse Suppression	Enable/disable suppression of interference pulses.
Sensor Data → <i>Sensor Data</i> , p. 70	Sensoface	Enable/disable display of Sensoface messages and icons.
	Sensor Monitoring Details	Option to enter individual limits for monitoring slope and zero point. Enable/disable Sensocheck sensor monitoring. Set whether Sensocheck should generate Failure or Maintenance Required messages. Option to enter individual values before a message is triggered for response time, sensor wear, sensor operating time, and SIP counter; also CIP counter and autoclaving counter with pH/ORP sensors; also operating point and leakage current with ISFET sensors.
Cal Presettings	Presetting of calibration mode and corresponding parameters, configuration of drift check and calibration timer. → <i>Calibration Presettings</i> , p. 73	
TC Process Medium	→ <i>Temperature Compensation of Process Medium</i> , p. 74	
ORP / rH Value	With Memosens pH/ORP sensor: Selection of reference electrode: Ag/AgCl, KCl 1 mol, Ag/AgCl, KCl 3 mol, Hg,Tl/TlCl, KCl 3.5 mol, Hg/Hg ₂ SO ₄ , K ₂ SO ₄ sat Enable/disable ORP conversion to standard hydrogen electrode SHE. Calculate rH with or without factor.	
Delta Function	Display deviations from a preset value (delta value): Output value = measured value – delta value → <i>Delta Function</i> , p. 74	
Messages	Enable/disable messages for the separate process variables, or specify individual limits. → <i>Messages</i> , p. 75	

Selecting a Digital ISM pH Sensor (TAN Option FW-E053)

Parameter Setting ▶ Sensor Selection [I] [II] ▶ Sensor Selection [II]

Selection of an ISM pH sensor connected to the MK-PH015N measuring module:

Module: MK-PH

Mode: ISM

Adjustable Parameters for ISM pH Sensors Parameter Setting ▶ [II] ISM pH

Input Filter	Pulse Suppression	Enable/disable suppression of interference pulses.
Sensor Data → <i>Sensor Data</i> , p. 70	Sensoface	Enable/disable display of Sensoface messages and icons.
	Sensor Monitoring Details	Option to enter individual limit values for monitoring slope, zero point, ORP offset, Sensocheck, reference electrode/glass electrode, response time, sensor operating time, TTM maintenance timer, DLI lifetime indicator, CIP/SIP counters, autoclaving counter. Set whether to generate Failure or Maintenance Required messages if exceeded.
Cal Presettings	Presetting of calibration mode with corresponding parameters, configuration of calibration timer and ORP check.	
TC Process Medium	→ <i>Temperature Compensation of Process Medium</i> , p. 74	
ORP/rH Value	Selection of reference electrode: Ag/AgCl, KCl 1 mol, Ag/AgCl, KCl 3 mol, Hg, Tl/TlCl, KCl 3.5 mol, Hg/Hg ₂ SO ₄ , K ₂ SO ₄ sat	
	Enable/disable ORP conversion to standard hydrogen electrode SHE.	
	Calculate rH with or without factor.	
Delta Function	Display deviations from a preset value (delta value): Output value = measured value – delta value → <i>Delta Function</i> , p. 74	
Messages	Enable/disable messages for the separate process variables, or specify individual limits. → <i>Messages</i> , p. 75	

More information on the use of ISM sensors → *Digital ISM Sensors (FW-E053)*, p. 248

Selecting an Analog pH Sensor

Parameter Setting ▶ Sensor Selection [I] [II] ▶ Sensor Selection [II]

Selection of a pH or pH/ORP sensor connected to the MK-PH015N measuring module:

Module: MK-PH

Mode: Analog

Adjustable Parameters for Analog Sensors

Parameter Setting ▶ [II] Analog pH

Input Filter	Pulse Suppression	Enable/disable suppression of interference pulses.
Sensor Data → <i>Sensor Data</i> , p. 70	Sensor Type and Sensoface	Sensoface, temperature monitoring, and the details of sensor monitoring can be set, depending on the sensor type.
	Temperature Detection	Select temperature probe, set measuring and calibration temperature.
	Sensor Monitoring Details	Slope, zero point, set Sensocheck of reference and glass electrodes, and select response time.
Cal Presettings	Presetting of calibration mode and calibration timer with corresponding parameters. → <i>Calibration Presettings</i> , p. 73	
TC Process Medium	→ <i>Temperature Compensation of Process Medium</i> , p. 74	
ORP / rH Value	With pH/ORP sensor: Selection of reference electrode.	
	Enable/disable ORP conversion to standard hydrogen electrode SHE.	
	Calculate rH with or without factor.	

Adjustable Parameters for Analog Sensors**Parameter Setting ▶ [II] Analog pH**

Delta Function	Display deviations from a preset value (delta value): Output value = measured value – delta value → <i>Delta Function, p. 74</i>
Messages	Enable/disable messages for the separate process variables, or specify individual limits. → <i>Messages, p. 75</i>

Selection of an Analog Pfaudler pH Sensor with TAN Option FW-E017 (Pfaudler Sensors)**Parameter Setting ▶ Sensor Selection [I] [II] ▶ Sensor Selection [II]**

Selection of a Pfaudler pH sensor connected to the MK-PH015N measuring module:

Module:	MK-PH
Mode:	Analog

Adjustable Parameters for Analog Pfaudler Sensors**Parameter Setting ▶ [II] Analog pH**

Input Filter	Pulse Suppression	Enable/disable suppression of interference pulses.
Sensor Data → <i>Sensor Data, p. 70</i>	Sensor Type	Select sensor type:
		Pfaudler Standard (enameled pH sensor)
		Pfaudler Diff. (enameled pH differential sensor)
	Glass El. Diff. (pH differential sensor with glass electrode)	
	Sensoface	Adjust Sensoface.
Temperature Detection	Select temperature probe, set measuring and calibration temperature.	
Sensor Monitoring Details	Slope, zero point, set Sensocheck of reference and glass electrodes. Select "Individual" monitoring and enter sensor values in accordance with sensor datasheet.	
Cal Presettings	Presetting of calibration mode and calibration timer with corresponding parameters. → <i>Calibration Presettings, p. 73</i>	
TC Process Medium	→ <i>Temperature Compensation of Process Medium, p. 74</i>	
Delta Function	Display deviations from a preset value (delta value): Output value = measured value – delta value → <i>Delta Function, p. 74</i>	
Messages	Enable/disable messages for the separate process variables, or specify individual limits. → <i>Messages, p. 75</i>	

More information on the use of Pfaudler sensors → *Pfaudler Sensors (FW-E017), p. 242*

6.8.1 Sensor Data

Memosens Sensors

Memosens sensors provide relevant sensor data automatically.

Analog Sensors

The sensor type must be selected if using analog sensors:

Parameter Setting > [II] Analog ... > Sensor Data

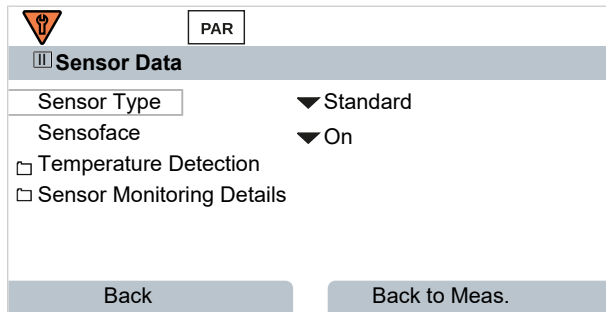

01. In **Temperature Detection**, select the used temperature probe and whether the temperature is to be measured automatically or manually during measurement and/or calibration.

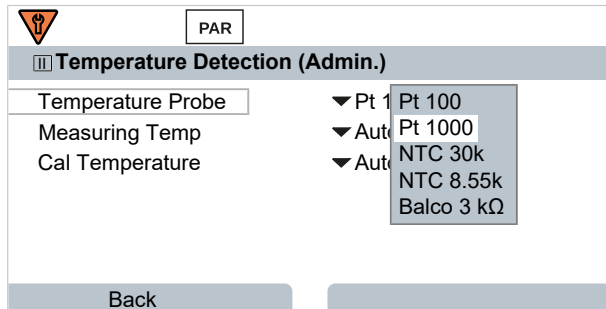

Sensoface

The Sensoface icons provide the user with diagnostic information on wear and required maintenance of the sensor. In measuring mode, an icon (happy, neutral, or sad smiley) is shown on the display to reflect the continuous monitoring of the sensor parameters.

You can configure the current outputs so that a Sensoface message generates a 22-mA error signal:

Parameter Setting > Inputs/Outputs > Current Outputs > Current Output I... > Behavior During Messages

The Sensoface message can also be output via a relay contact:

Parameter Setting > Inputs/Outputs > Relay Contacts > Contact K... → Usage: Sensoface, p. 64

Sensoface monitors the pH sensor on the basis of the following parameters: slope, zero point, glass impedance (if Sensoscheck is enabled), response time, calibration timer, wear

Enabling/Disabling Sensoface



Sensoface is enabled and disabled in the **Sensor Data** submenu:

Parameter Setting > [I] [II] [Sensor] > Sensor Data

Note: After a calibration, a smiley is always displayed for confirmation, even if Sensoface is disabled.

Adjusting Sensor Monitoring

01. **Sensor Data** ▶ **Sensor Monitoring Details** .
02. Open a sensor parameter, e.g., **Slope** .
03. Set **Monitoring** of the slope to automatic or individual.
04. If you select "Individual": The nominal slope and the min/max limits can be entered.
05. In the **Message** menu item, select whether and how an exceeded limit is to be displayed:

Off	No message, but the parameter is still shown in the Diagnostics menu and on the sensor diagram.
Failure	A Failure message is shown in off-limit conditions; the corresponding NAMUR icon  is displayed. If "Display Color NE107" is selected, the measurement display is shown with red backlighting.
Maintenance	A Maintenance Required message is shown in off-limit conditions; the corresponding NAMUR icon  is displayed. If "Display Color NE107" is selected, the measurement display is shown with blue backlighting.
06. Set the sensor monitoring details for other sensor data, e.g., zero point, Sensocheck, response time, sensor wear, or sensor operating time.
07. Using the **left softkey: Back**, confirm the sensor monitoring settings and adjust further parameters.
or
Using the **right softkey: Back to Meas.**, confirm the sensor monitoring settings and end the function check (HOLD).

CIP/SIP Counters

CIP/SIP counters are available for the following pH sensor types:

	Memosens pH	Memosens pH/ORP	ISM pH/ORP ¹⁾
CIP counter		+	+
SIP counter	+	+	+

CIP/SIP cycles are used to clean or sterilize process-wetted parts in the process. Depending on the application, either one chemical (alkaline solution, water) or several chemicals (alkaline solution, water, acidic solution, water) are used.

- CIP temperature > 55 °C/131 °F
- SIP temperature > 115 °C/239 °F

The cleaning (cleaning in place) and sterilization (sterilization in place) cycles are counted to measure the load on the sensor, e.g., in biotechnology applications.

Note: If measurements are generally taken at high temperatures (> 55 °C/131 °F), the counters should be switched off.

When a CIP/SIP counter is switched on, a maximum number of cycles can be entered. As soon as the counter has reached the specified value, a Maintenance Required message is triggered and the NAMUR icon  is displayed; the measurement display is shown with blue backlighting (display color: NE107).



Note: A CIP or SIP cycle is only entered into the logbook 2 hours after the start to ensure that the cycle is complete.

Note: With Memosens sensors, an entry is also made in the sensor.

¹⁾ With TAN option FW-E053

Adjusting CIP/SIP Counters

01. **Sensor Monitoring Details** ▶ **CIP Counter / SIP Counter**
02. **Monitoring** : Off or individual
03. If you select "Individual": Enter the maximum number of CIP/SIP cycles.
04. In the **Message** menu item, select whether and how an exceeded limit is to be displayed:

Off	No message.
Failure	A Failure message is shown in off-limit conditions; the corresponding NAMUR icon  is displayed. If "Display Color NE107" is selected, the measurement display is shown with red backlighting.
Maintenance	A Maintenance Required message is shown in off-limit conditions; the corresponding NAMUR icon  is displayed. If "Display Color NE107" is selected, the measurement display is shown with blue backlighting.

Autoclaving Counter



An autoclaving counter is available for the following sensor types:

- Memosens pH/ORP
- ISM pH/ORP (with TAN option FW-E053)

Autoclaving cycles are counted to help measure the load on the sensor.

Adjusting the Autoclaving Counter

01. **Sensor Monitoring Details** ▶ **Autoclaving Counter**
02. **Monitoring** : Off or individual
03. If you select "Individual": Enter the maximum number of autoclaving cycles.
04. In the **Message** menu item, select whether and how an exceeded limit is to be displayed:

Off	No message.
Failure	A Failure message is shown in off-limit conditions; the corresponding NAMUR icon  is displayed. If "Display Color NE107" is selected, the measurement display is shown with red backlighting.
Maintenance	A Maintenance Required message is shown in off-limit conditions; the corresponding NAMUR icon  is displayed. If "Display Color NE107" is selected, the measurement display is shown with blue backlighting.

After each autoclaving process, the autoclaving counter must be manually incremented in the device's Maintenance menu:

Maintenance ▶ **[I][II] [Sensor]** ▶ **Autoclaving Counter**

6.8.2 Calibration Presettings

The calibration presettings can be defined in the parameter settings or adjusted directly in the Calibration menu prior to the calibration.

Calibration mode: Presetting of calibration mode, e.g., Calimatic, Manual, Product Calibration, Data Entry, Temperature

If Calimatic automatic calibration is selected, the buffer set to be used must also be selected.

Calibration points: Selection of how many calibration points are to be used in the calibration

Drift check: Sets the sensitivity of the drift check (fine, standard, coarse)

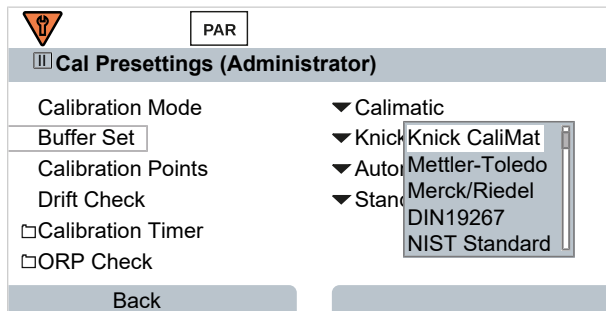

Calibration Timer

When a preset calibration interval expires, the calibration timer generates a message text to indicate the need for calibration. If "Auto" is selected, the interval is set to 168 h. If "Individual" is selected, you can select a custom interval.

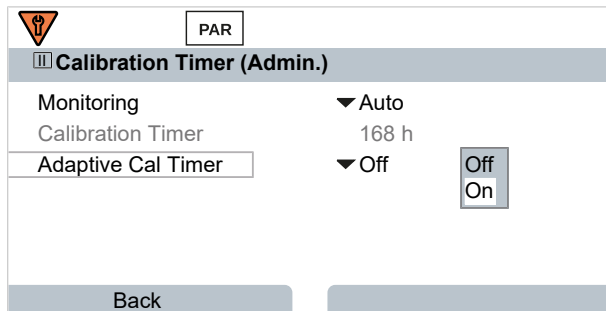

Note: If Sensoface is enabled, a neutral smiley is displayed once 80 % of the interval has expired. Once the entire interval has expired, a sad smiley is shown, a Maintenance Required message is generated, and the corresponding NAMUR icon  is displayed and the measurement display is shown with blue backlighting (display color: NE107). If the current outputs are configured accordingly, a 22-mA error signal is generated.

Adaptive calibration timer: The time until the next calibration is automatically shortened depending on the temperature and pH value.

Old sensor = timer expires faster.

The following measuring conditions shorten the adaptive calibration timer interval:

- Temperatures above 30 °C/86 °F
- pH ranges below pH 2 or above pH 12

The message test is displayed in the **Diagnostics** menu:

Diagnostics ▶ **Message List**

The calibration timer is reset after each calibration.

Settings can be changed in the **Cal Presettings** submenu:

Parameter Setting ▶ **[I] [II] [Sensor]** ▶ **Cal Presettings**

6.8.3 Temperature Compensation of Process Medium

Note: If temperature compensation of the process medium is enabled, "TC" is shown on the display in measuring mode.

The following are available for temperature compensation:

- Linear with input of a temperature coefficient TC
- Ultrapure water
- Table

Linear Temperature Compensation of Process Medium

If the medium's pH value changes in linear fashion with the temperature, the temperature coefficient TC can be determined for temperature compensation in %/K as follows:

$$TC = (pH_{25} - pH_T) \cdot 100 / (25 \text{ °C} - T) \text{ [%/K]}$$

TC	Temperature coefficient [%/K]
pH ₂₅	pH value at 25 °C
pH _T	pH value at measuring temperature T
T	Measuring temperature [°C]

Table

When using process media with a known pH value temperature response, the pH output value can be corrected using a table. The percentage deviation from the measured value in % can be entered for temperatures between 0 and 95 °C in steps of 5 °C. The pH output value is then corrected by the corresponding percentage deviation from the measured value in %, depending on the measuring temperature. Table values are linearly interpolated. If the temperature falls below or exceeds the specified value (< 0 °C or > 95 °C), the last value in the table is used for calculation.

The table must be completed with the following values in steps of 5 °C:

$$((pH_{25} / pH_T) - 1) \cdot 100 \text{ [%]}$$

pH ₂₅	pH value at 25 °C
pH _T	pH value at measuring temperature T

Settings can be changed in the **TC Process Medium** submenu:

Parameter Setting ▶ [I] [II] ... pH ▶ TC Process Medium

Note: If the delta function and TC correction are enabled at the same time, the TC correction is carried out first and the delta value is then deducted.

6.8.4 Delta Function

Note: If the delta function is enabled, "Δ" is shown on the display in measuring mode.

If a delta value is specified, the measuring system calculates the difference
output value = measured value – delta value

The delta value can be set using the "+" or "-" signs. If using a negative sign, the delta value is added to the measured value.

The delta value is adjusted in the **Delta Function** submenu:

Parameter Setting ▶ [I] [II] [Sensor] ▶ Delta Function

All outputs are controlled by the output value; the displays show the output value.

Note: If the delta function and TC correction are enabled at the same time, the TC correction is carried out first and the delta value is then deducted.

6.8.5 Messages

All values determined by the measuring module or sensor can generate messages.

Messages can be configured for the following process variables:

- pH value
- ORP (with pH/ORP sensor)
- rH value (with pH/ORP sensor)
- Temperature
- pH voltage

Configuring Messages

Process variable limits for the monitoring range can be selected in the **Messages** submenu:



Parameter Setting ▶ [I] [II] [Sensor] ▶ Messages ▶ Messages [Process Variable] ▶ Monitoring

- Max. Device Limits: Messages are generated when the process variable is outside the measuring range. The “failure” or “out of specification” icons are shown; the corresponding relay contact is enabled. The current outputs can signal a 22-mA message (user-defined).
- Variable Limits: Upper and lower limits at which a message is generated can be defined for the “Failure” and “Out of Specification” messages.

Note: If display color NE107 is selected in Parameter Setting (factory setting), measured values are backlit in accordance with their NAMUR color when NAMUR messages are available.

Parameter Setting ▶ General ▶ Display

Displaying Messages

01. Go to the Diagnostics menu if the “failure” , “maintenance required” , or “out of specification”  icons are flashing on the display: Menu Selection ▶ Diagnostics ▶ Message List
 - ✓ All active messages are displayed in the **Message List** menu item with the following information: Error number, type (failure, maintenance required, out of specification), channel, message text.
 02. You can scroll forward and backward using the **up/down arrow keys**.
- The error message disappears from the display around 2 s after the error is cleared.

An overview of message texts with notes on troubleshooting can be found in the “Troubleshooting” chapter. → *Malfunction States, p. 161*

6.9 ORP Process Variable

Note: Function check (HOLD) is active.

Note: After changing the process variable or measuring mode, Stratos Multi retains its settings but needs to be reconfigured.

Configuration of a Memosens pH/ORP sensor (combination sensor) → *pH Process Variable, p. 67*

Selecting a Memosens ORP Sensor

Parameter Setting ▶ Sensor Selection [I] [II] ▶ Sensor Selection [I]

Selection of a Memosens ORP sensor connected to the RS-485 interface (terminals 1 ... 5):

Process variable: Auto or pH
 Mode: Memosens
 Functionality: ORP

Selecting a Second Memosens ORP Sensor

Parameter Setting ▶ Sensor Selection [I] [II] ▶ Sensor Selection [II]

Selection of a second Memosens ORP sensor connected to the MK-MS095N measuring module:

Module: MK-MS
 Process variable: pH
 Mode: Memosens
 Functionality: ORP

Adjustable Parameters for Memosens ORP Sensors Parameter Setting ▶ [I] Memosens ORP

Input Filter	Pulse Suppression	Enable/disable suppression of interference pulses.
Sensor Data → <i>Sensor Data, p. 77</i>	Sensoface	Enable/disable display of Sensoface messages and icons.
	Sensor Monitoring Details	Option to enter individual limits for monitoring ORP offset. Option to enter individual limits before a message for sensor operating time and SIP counter is triggered.
Cal Presettings	Presetting of the calibration mode; configuration of the calibration timer and ORP check. → <i>Calibration Presettings, p. 78</i>	
ORP/rH Value	Selection of reference electrode.	
	Enable/disable ORP conversion to standard hydrogen electrode SHE.	
	If using a pH sensor connected via a module at the same time: Calculate rH with or without factor.	
Delta Function	Display deviations from a preset value (delta value): Output value = measured value – delta value → <i>Delta Function, p. 78</i>	
Messages	Enable/disable messages for the separate process variables, or specify individual limits. → <i>Messages, p. 79</i>	

Selecting an Analog ORP Sensor

Parameter Setting ▶ Sensor Selection [I] [II] ▶ Sensor Selection [II]

Selection of an ORP sensor connected to the MK-PH015N measuring module:

Module: MK-PH
 Mode: Analog

When using an analog ORP sensor, the menus are the same as for an analog pH sensor:

Parameter Setting ▶ [II] Analog pH

6.9.1 Sensor Data

Memosens sensors provide relevant sensor data automatically.

Sensoface

The Sensoface icons provide the user with diagnostic information on wear and required maintenance of the sensor. In measuring mode, an icon (happy, neutral, or sad smiley) is shown on the display to reflect the continuous monitoring of the sensor parameters.

You can configure the current outputs so that a Sensoface message generates a 22-mA error signal:

Parameter Setting ▶ Inputs/Outputs ▶ Current Outputs ▶ Current Output I... ▶ Behavior During Messages

The Sensoface message can also be output via a relay contact:

Parameter Setting ▶ Inputs/Outputs ▶ Relay Contacts ▶ Contact K... → Usage: Sensoface, p. 64

Enabling/Disabling Sensoface



Sensoface is enabled and disabled in the **Sensor Data** submenu:

Parameter Setting ▶ [I] [II] [Sensor] ▶ Sensor Data

Note: After a calibration, a smiley is always displayed for confirmation, even if Sensoface is disabled.

Adjusting Sensor Monitoring

01. **Sensor Data** ▶ **Sensor Monitoring Details** .
02. Open a sensor parameter, e.g., **ORP Offset** .
03. Set **Monitoring** of the ORP offset to automatic or individual.
04. If you select "Individual": The nominal ORP offset and the min/max limits can be entered.
05. In the **Message** menu item, select whether and how an exceeded limit is to be displayed:

Off	No message.
Failure	A Failure message is shown in off-limit conditions; the corresponding NAMUR icon  is displayed. If "Display Color NE107" is selected, the measurement display is shown with red backlighting.
Maintenance	A Maintenance Required message is shown in off-limit conditions; the corresponding NAMUR icon  is displayed. If "Display Color NE107" is selected, the measurement display is shown with blue backlighting.
06. Set the sensor monitoring details for further sensor data such as sensor operating time or SIP counter.
07. Using the **left softkey: Back**, confirm the sensor monitoring settings and adjust further parameters.
or
Using the **right softkey: Back to Meas.**, confirm the sensor monitoring settings and end the function check (HOLD).

6.9.2 Calibration Presettings

The calibration presettings can be defined in the parameter settings or adjusted directly in the Calibration menu prior to the calibration.

Calibration mode: Presetting of the calibration mode, e.g., ORP data entry, ORP adjustment, ORP check, temperature

Calibration timer: When a preset calibration interval expires, the calibration timer generates a message text to indicate the need for calibration. If "Auto" is selected, the interval is set to 168 h. If "Individual" is selected, you can select a custom interval.

Note: If Sensoface is enabled, the smiley is "sad" as soon as the interval has expired. You can configure the current outputs so that a Sensoface message generates a 22-mA error signal.

ORP check: Settings for test period in seconds and test difference in millivolts

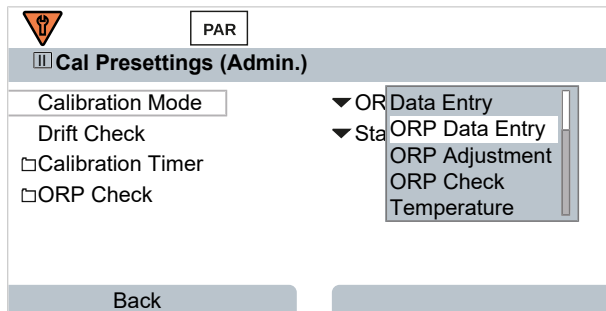

Settings can be changed in the **Cal Presettings** submenu:

Parameter Setting ▶ [I] [II] [Sensor] ▶ **Cal Presettings**

6.9.3 Delta Function

Note: If the delta function is enabled, "Δ" is shown on the display in measuring mode.

If a delta value is specified, the measuring system calculates the difference
 output value = measured value – delta value

The delta value can be set using the "+" or "-" signs. If using a negative sign, the delta value is added to the measured value.

The delta value is adjusted in the **Delta Function** submenu:

Parameter Setting ▶ [I] [II] [Sensor] ▶ **Delta Function**

All outputs are controlled by the output value; the displays show the output value.

Note: If the delta function and TC correction are enabled at the same time, the TC correction is carried out first and the delta value is then deducted.

6.9.4 Messages

All values determined by the measuring module or sensor can generate messages.

Messages can be configured for the following process variables:

- ORP voltage
- Temperature

Configuring Messages

Process variable limits for the monitoring range can be selected in the **Messages** submenu:



Parameter Setting ▶ [I] [II] [Sensor] ▶ Messages ▶ Messages [Process Variable] ▶ Monitoring

- Max. Device Limits: Messages are generated when the process variable is outside the measuring range. The “failure” or “out of specification” icons are shown; the corresponding relay contact is enabled. The current outputs can signal a 22-mA message (user-defined).
- Variable Limits: Upper and lower limits at which a message is generated can be defined for the “Failure” and “Out of Specification” messages.

Note: If display color NE107 is selected in Parameter Setting (factory setting), measured values are backlit in accordance with their NAMUR color when NAMUR messages are available.

Parameter Setting ▶ General ▶ Display

Displaying Messages

01. Go to the Diagnostics menu if the “failure” , “maintenance required” , or “out of specification”  icons are flashing on the display: Menu Selection ▶ Diagnostics ▶ Message List
 - ✓ All active messages are displayed in the **Message List** menu item with the following information: Error number, type (failure, maintenance required, out of specification), channel, message text.
02. You can scroll forward and backward using the **up/down arrow keys**.
The error message disappears from the display around 2 s after the error is cleared.
An overview of message texts with notes on troubleshooting can be found in the “Troubleshooting” chapter. → *Malfunction States, p. 161*

6.10 Conductivity (Contacting) Process Variable

Note: Function check (HOLD) is active.

Note: After changing the process variable or measuring mode, Stratos Multi retains its settings but needs to be reconfigured.

Selecting a Memosens Conductivity Sensor

Parameter Setting ▶ Sensor Selection [I] [II] ▶ Sensor Selection [I]

Selection of a Memosens conductivity sensor connected to the RS-485 interface (terminals 1 ... 5):

Process variable: Auto or Conductivity
 Mode: Memosens
 Functionality: 2-electrode sensor or 4-electrode sensor (depending on sensor type)

Selecting a Second Memosens Conductivity Sensor

Parameter Setting ▶ Sensor Selection [I] [II] ▶ Sensor Selection [II]

Selection of a second Memosens conductivity sensor connected to the MK-MS095N measuring module:

Module: MK-MS
 Process variable: Conductivity
 Mode: Memosens
 Functionality: 2-electrode sensor or 4-electrode sensor (depending on sensor type)

Adjustable Parameters for Memosens Conductivity Sensors Parameter Setting ▶ [I] [II] Memosens Cond

Input Filter	Pulse Suppression	Enable/disable suppression of interference pulses.
Sensor Data → <i>Sensor Data</i> , p. 81	Sensoface	Enable/disable display of Sensoface messages and icons.
	Sensor Monitoring Details	Option to enter individual limits for monitoring cell constants. Disable Sensocheck sensor monitoring or select whether Sensocheck should generate failure or maintenance required messages. Option to enter individual limits before a message for SIP counter, CIP counter, and sensor operating time is triggered.
Cal Presettings	Presetting of calibration mode with corresponding parameters. → <i>Calibration Presettings</i> , p. 84	
TC Process Medium	→ <i>Temperature Compensation of Process Medium</i> , p. 84	
Concentration	→ <i>Concentration (TAN Option FW-E009)</i> , p. 85	
TDS	Enable/disable the TDS function. → <i>TDS Function</i> , p. 85	
USP	Enable/disable USP function for monitoring ultrapure water and set the USP limit. → <i>USP Function</i> , p. 85	
Messages	Enable/disable messages for the separate process variables, or specify individual limits. → <i>Messages</i> , p. 86	

Selecting an Analog Conductivity Sensor

Parameter Setting > Sensor Selection [I] [II] > Sensor Selection [II]

Selection of a conductivity sensor connected to the MK-COND025N measuring module:

Module: MK-COND
 Mode: Analog

Adjustable Parameters for Analog Conductivity Sensors Parameter Setting > [II] Analog Cond

Input Filter	Pulse Suppression	Enable/disable suppression of interference pulses.
Sensor Data → <i>Sensor Data</i> , p. 81	Sensor Type	Select the used sensor type: 2-electrode sensor, 4-electrode sensor, SE600, SE602, SE603, SE604, SE610, SE620, SE630.
	Nom. Cell Constant	Enter when 2-el. or 4-el. sensor is selected.
	Sensoface	Enable/disable display of Sensoface messages and icons.
	Sensocheck	Enable or disable Sensocheck to generate failure or maintenance required messages.
	Temperature Detection	Set measuring and calibration temperature. When 2-el. or 4-el. sensor is selected: Select temperature detector.
Cal Presettings	Presetting of calibration mode with corresponding parameters. → <i>Calibration Presettings</i> , p. 84	
TC Process Medium	→ <i>Temperature Compensation of Process Medium</i> , p. 84	
Concentration	→ <i>Concentration (TAN Option FW-E009)</i> , p. 85	
TDS	Enable/disable the TDS function → <i>TDS Function</i> , p. 85	
USP	Enable/disable USP function for monitoring ultrapure water and set the USP limit. → <i>USP Function</i> , p. 85	
Messages	Enable/disable messages for the separate process variables, or specify individual limits. → <i>Messages</i> , p. 86	

6.10.1 Sensor Data

Memosens sensors provide relevant sensor data automatically.

The sensor type must be selected if using analog sensors:

Parameter Setting > [II] Analog ... > Sensor Data

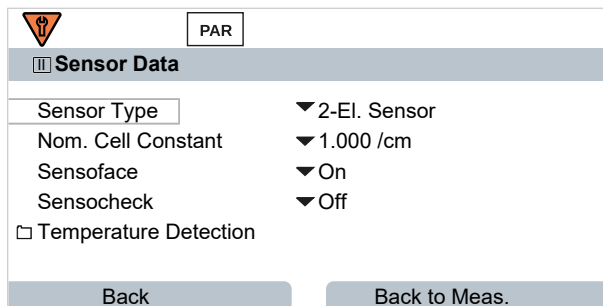

01. Select the **Sensor Type**.
02. Enter the sensor's nominal cell constant.
03. In **Temperature Detection**, select the used temperature probe and whether the temperature is to be measured automatically or manually during measurement and/or calibration.

Sensoface

The Sensoface icons provide the user with diagnostic information on wear and required maintenance of the sensor. In measuring mode, an icon (happy, neutral, or sad smiley) is shown on the display to reflect the continuous monitoring of the sensor parameters.

You can configure the current outputs so that a Sensoface message generates a 22-mA error signal:

Parameter Setting ▶ Inputs/Outputs ▶ Current Outputs ▶ Current Output I... ▶ Behavior During Messages

The Sensoface message can also be output via a relay contact:

Parameter Setting ▶ Inputs/Outputs ▶ Relay Contacts ▶ Contact K... → Usage: Sensoface, p. 64

Sensoface monitors the conductivity sensor on the basis of the following parameters:

cell constant, polarization (if Sensocheck is enabled)

With Memosens sensors, also: number of CIP and SIP cycles compared to the specified "Sensor Monitoring Details".

Enabling/Disabling Sensoface

Sensoface is enabled and disabled in the **Sensor Data** submenu:

Parameter Setting ▶ [I] [II] [Sensor] ▶ Sensor Data

Note: After a calibration, a smiley is always displayed for confirmation, even if Sensoface is disabled.

Adjusting Sensor Monitoring

Note: Function active for digital sensors.

01. **Sensor Data** ▶ **Sensor Monitoring Details** .

02. Open a sensor parameter, e.g., **Cell Constant** .

03. Set **Monitoring** of the cell constant to automatic or individual.

04. If you select "Individual": The nominal cell constant and the min/max limits can be entered.

05. In the **Message** menu item, select whether and how an exceeded limit is to be displayed:

Off No message.

Failure A Failure message is shown in off-limit conditions; the corresponding NAMUR icon  is displayed. If "Display Color NE107" is selected, the measurement display is shown with red backlighting.

Maintenance A Maintenance Required message is shown in off-limit conditions; the corresponding NAMUR icon  is displayed. If "Display Color NE107" is selected, the measurement display is shown with blue backlighting.

06. Set the sensor monitoring details for further sensor data, e.g., Sensocheck, sensor operating time, or CIP/SIP counter.

07. Using the **left softkey: Back**, confirm the sensor monitoring settings and adjust further parameters.
or

Using the **right softkey: Back to Meas.**, confirm the sensor monitoring settings and end the function check (HOLD).

CIP/SIP Counters

CIP/SIP counters are available for the following conductivity sensor types:

- Memosens 2-electrode/4-electrode sensors

CIP/SIP cycles are used to clean or sterilize process-wetted parts in the process. Depending on the application, either one chemical (alkaline solution, water) or several chemicals (alkaline solution, water, acidic solution, water) are used.

- CIP temperature > 55 °C/131 °F
- SIP temperature > 115 °C/239 °F

The cleaning (cleaning in place) and sterilization (sterilization in place) cycles are counted to measure the load on the sensor, e.g., in biotechnology applications.

Note: If measurements are generally taken at high temperatures (> 55 °C/131 °F), the counters should be switched off.

When a CIP/SIP counter is switched on, a maximum number of cycles can be entered. As soon as the counter has reached the specified value, a Maintenance Required message is triggered and the NAMUR icon  is displayed; the measurement display is shown with blue backlighting (display color: NE107).

Note: A CIP or SIP cycle is only entered into the logbook 2 hours after the start to ensure that the cycle is complete.

Note: With Memosens sensors, an entry is also made in the sensor.

Adjusting CIP/SIP Counters

01. [Sensor Monitoring Details](#) ▶ [CIP Counter](#) / [SIP Counter](#)

02. [Monitoring](#) : Off or individual

03. If you select "Individual": Enter the maximum number of CIP/SIP cycles.

04. In the [Message](#) menu item, select whether and how an exceeded limit is to be displayed:

Off No message.

Failure A Failure message is shown in off-limit conditions; the corresponding NAMUR icon  is displayed. If "Display Color NE107" is selected, the measurement display is shown with red backlighting.

Maintenance A Maintenance Required message is shown in off-limit conditions; the corresponding NAMUR icon  is displayed. If "Display Color NE107" is selected, the measurement display is shown with blue backlighting.

6.10.2 Calibration Presettings

The calibration presettings can be defined in the parameter settings or adjusted directly in the Calibration menu prior to the calibration.

Calibration Mode: Presetting of calibration mode, e.g., automatic, manual, product calibration, data entry, temperature

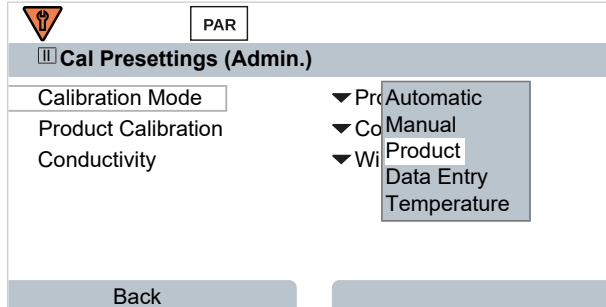

Further options are available depending on the calibration mode.

Automatic	Product calibration	
Selection of calibration solution	Conductivity:	Selection with/without temperature compensation
	Concentration: ¹⁾	Selection of medium

Calibration presettings can be changed in the **Cal Presettings** submenu:

Parameter Setting ▶ [I] [II] ... Cond ▶ Cal Presettings

6.10.3 Temperature Compensation of Process Medium

Note: If temperature compensation of the process medium is enabled, "TC" is shown on the display in measuring mode.

The following are available for temperature compensation:

- Off
- Linear (enter temperature coefficient TC)
- EN 27888 (natural waters)
- Ultrapure water (with different trace impurities)

Trace Impurities in Ultrapure Water

NaCl	Neutral ultrapure water, for conductivity measurement in water processing downstream of gravel bed filter
HCl	Acidic ultrapure water, for conductivity measurement downstream of cation filter
NH ₃	Ammoniacal ultrapure water
NaOH	Alkaline ultrapure water

Settings can be changed in the **TC Process Medium** submenu:

Parameter Setting ▶ [I] [II] ... Cond ▶ TC Process Medium

¹⁾ First enable TAN option FW-E009. → *Concentration Determination (FW-E009)*, p. 237

6.10.4 Concentration (TAN Option FW-E009)

With TAN option FW-E009, the substance concentration in percent by weight (wt%) can be determined for H₂SO₄, HNO₃, HCl, NaOH, NaCl, and Oleum from the measured conductivity and temperature values. A custom solution can also be specified.

The menu is only shown if the TAN option is activated.

Parameter Setting ▶ [I] [II] ... Cond(I) ▶ Concentration

See also

→ *Concentration Determination (FW-E009), p. 237*

6.10.5 TDS Function

TDS (total dissolved solids) = weight of dissolved solids that influence conductivity

The TDS function provides a quick way of determining the evaporation residue of water. A TDS factor must be entered for this purpose.

The factor establishes a simple linear relationship between measured conductivity and evaporation residue. It is dependent on the composition of the medium and must be empirically determined by the user.

6.10.6 USP Function

Monitoring Ultrapure Water in the Pharmaceutical Industry

The conductivity of ultrapure water in the pharmaceutical industry can be monitored online in accordance with the guideline "USP" (U.S. Pharmacopeia), Annex 5, Section 645 "Water Conductivity". The conductivity is measured without temperature compensation and is compared with limits. The water is usable without any further testing when the conductivity is below the USP limit.

Configuring the USP Function



The USP value can be configured as a process variable USP% for output (display, current output, limit, measurement recorder)

Settings can be changed in the USP submenu:

Parameter Setting ▶ [I] [II] ... Cond(I) ▶ USP

Reduced limit: The USP limit can be reduced down to 10 %.

Monitoring: Select whether and how an exceeded limit is to be displayed.

Off	No message, but the parameter is still shown in the Diagnostics menu.
Failure	A Failure message is shown in off-limit conditions; the corresponding NAMUR icon  is displayed. If "Display Color NE107" is selected, the measurement display is shown with red backlighting.
Maintenance	A Maintenance Required message is shown in off-limit conditions; the corresponding NAMUR icon  is displayed. If "Display Color NE107" is selected, the measurement display is shown with blue backlighting.

USP Function: Specifying a Relay Contact

The USP function can also be assigned to a relay contact:

Parameter setting ▶ Inputs/Outputs ▶ Relay Contacts ▶ Contact K... → *Usage: USP Output, p. 64*

Display of the USP Function in the Diagnostics Menu

Diagnostics ▶ [I] [II] ... Cond(I) ▶ USP Function

Display of the USP limit, the reduced limit, and conductivity.

6.10.7 Messages

All values determined by the measuring module or sensor can generate messages.

Messages can be configured for the following process variables:

- Conductivity
- Resistivity
- Concentration (with TAN option FW-E009)
- Temperature
- Salinity

Configuring Messages

Process variable limits for the monitoring range can be selected in the **Messages** submenu:



Parameter Setting ▶ [I] [II] [Sensor] ▶ Messages ▶ Messages [Process Variable] ▶ Monitoring

- Max. Device Limits: Messages are generated when the process variable is outside the measuring range. The “failure” or “out of specification” icons are shown; the corresponding relay contact is enabled. The current outputs can signal a 22-mA message (user-defined).
- Variable Limits: Upper and lower limits at which a message is generated can be defined for the “Failure” and “Out of Specification” messages.

Note: If display color NE107 is selected in Parameter Setting (factory setting), measured values are backlit in accordance with their NAMUR color when NAMUR messages are available.

Parameter Setting ▶ General ▶ Display

Displaying Messages

01. Go to the Diagnostics menu if the “failure” , “maintenance required” , or “out of specification”  icons are flashing on the display: Menu Selection ▶ Diagnostics ▶ Message List
 - ✓ All active messages are displayed in the **Message List** menu item with the following information: Error number, type (failure, maintenance required, out of specification), channel, message text.
 02. You can scroll forward and backward using the **up/down arrow keys**.
- The error message disappears from the display around 2 s after the error is cleared.
- An overview of message texts with notes on troubleshooting can be found in the “Troubleshooting” chapter. → *Malfunction States, p. 161*

6.11 Conductivity (Inductive) Process Variable

Note: Function check (HOLD) is active.

Note: After changing the process variable or measuring mode, Stratos Multi retains its settings but needs to be reconfigured.

Selecting a Digital Toroidal Conductivity Sensor

Parameter Setting ▶ Sensor Selection [I] [II] ▶ Sensor Selection [I]

Selection of a Memosens toroidal conductivity sensor connected to the RS-485 interface (terminals 1 ... 5):

Process variable: Auto or Conductivity (Induct.)
 Mode: Memosens
 Functionality: Condl

Selection of an SE670/SE680K toroidal digital conductivity sensor connected to the RS-485 interface (terminals 1 ... 5):

Process variable: Conductivity (Induct.)
 Mode: Other Digital
 Functionality: SE670/SE680K

Selecting a Second Digital Toroidal Conductivity Sensor

Parameter Setting ▶ Sensor Selection [I] [II] ▶ Sensor Selection [II]

Selection of a second Memosens conductivity sensor connected to the MK-MS095N measuring module:

Module: MK-MS
 Process variable: Conductivity (Induct.)
 Mode: Memosens
 Functionality: Condl

Selection of a second SE670/SE680K digital toroidal conductivity sensor connected to the MK-MS095N measuring module:

Module: MK-MS
 Process variable: Conductivity (Induct.)
 Mode: Other Digital

Adjustable Parameters for Digital or Memosens Sensors for Inductive Conductivity

Parameter Setting ▶ [I] [II] Digital/Memosens Condl

Input Filter	Pulse Suppression	Enable/disable suppression of interference pulses.
Sensor Data → <i>Sensor Data</i> , p. 89	Sensoface	Enable/disable display of the Sensoface icon.
	If "Other Digital" is selected: Sensochek	Monitoring of primary and secondary coils. Enable or disable Sensochek to generate Failure or Maintenance Required messages.
	If Memosens is selected: Sensor Monitoring Details	Option to enter individual limits for monitoring the cell factor. Sensochek: Monitoring of primary and secondary coils. Enable or disable Sensochek to generate Failure or Maintenance Required messages. Option to enter individual limits before a message for SIP counter, CIP counter, and sensor operating time is triggered.
Cal Presettings	Presetting of calibration mode with corresponding parameters. → <i>Calibration Presettings</i> , p. 91	
TC Process Medium	→ <i>Temperature Compensation of Process Medium</i> , p. 92	
Concentration	→ <i>Concentration (TAN Option FW-E009)</i> , p. 92	

Adjustable Parameters for Digital or Memosens Sensors for Inductive Conductivity

Parameter Setting ▶ [I] [II] Digital/Memosens Condl

TDS	Enable/disable the TDS function. → <i>TDS Function, p. 92</i>
USP	Enable/disable USP function for monitoring ultrapure water and set the USP limit. → <i>USP Function, p. 93</i>
Messages	Enable/disable messages for the separate process variables, or specify individual limits. → <i>Messages, p. 94</i>

Selecting an Analog Toroidal Conductivity Sensor

Parameter Setting ▶ Sensor Selection [I] [II] ▶ Sensor Selection [II]

Selection of a toroidal conductivity sensor connected to the MK-CONDI035N measuring module:

Module: MK-CONDI

Mode: Analog

Adjustable Parameters for Analog Toroidal Conductivity Sensors

Parameter Setting ▶ [II] Analog Condl

Input Filter	Pulse Suppression	Enable/disable suppression of interference pulses.
Sensor Data → <i>Sensor Data, p. 89</i>	Sensor Type	Select the used sensor type: SE655, SE656, SE660, ISC40, ISC40S, 5000 TC, other If you select "Other", please enter further sensor data.
	Sensoface	Enable/disable display of Sensoface messages and icons.
	Sensocheck	Monitoring of primary and secondary coils. Enable or disable Sensocheck to generate failure or maintenance required messages.
	Temperature Detection	Select temperature probe, set measuring and calibration temperature.
Cal Presettings	Presetting of calibration mode with corresponding parameters. → <i>Calibration Presettings, p. 91</i>	
TC Process Medium	→ <i>Temperature Compensation of Process Medium, p. 92</i>	
Concentration	→ <i>Concentration (TAN Option FW-E009), p. 92</i>	
TDS	Enable/disable the TDS function. → <i>TDS Function, p. 92</i>	
USP	Enable/disable USP function for monitoring ultrapure water and set the USP limit. → <i>USP Function, p. 93</i>	
Messages	Enable/disable messages for the separate process variables, or specify individual limits. → <i>Messages, p. 94</i>	

6.11.1 Sensor Data

Memosens sensors provide relevant sensor data automatically.

The sensor type must be selected if using analog sensors:

Parameter Setting ▶ [I] Analog ... ▶ Sensor Data

Sensor Data	
Sensor Type	▼ Other
Sensor Coding	F0031
Nom. Cell Factor	1.980 /cm
Transfer Ratio	▼ 100.00
Sensoface	▼ On
Sensocheck	Off

Back Back to Meas.

01. Select the **Sensor Type**

02. Enter the sensor coding, nominal cell factor, and transfer ratio.

03. In **Temperature Detection**, select the used temperature probe and whether the temperature is to be measured automatically or manually during measurement and/or calibration.

Note: The sensor coding for unknown sensor types can be requested from Knick (see the back page of this document for contact details)

Sensoface

The Sensoface icons provide the user with diagnostic information on wear and required maintenance of the sensor. In measuring mode, an icon (happy, neutral, or sad smiley) is shown on the display to reflect the continuous monitoring of the sensor parameters.

You can configure the current outputs so that a Sensoface message generates a 22-mA error signal:

Parameter Setting ▶ Inputs/Outputs ▶ Current Outputs ▶ Current Output I... ▶ Behavior During Messages

The Sensoface message can also be output via a relay contact:

Parameter Setting ▶ Inputs/Outputs ▶ Relay Contacts ▶ Contact K... → Usage: Sensoface, p. 64

Sensoface monitors the toroidal conductivity sensor on the basis of the following parameters: cell factor, zero point, and, if Sensocheck is enabled: primary/secondary coils and wires
With Memosens sensors, also: number of CIP and SIP cycles compared to the specified "Sensor Monitoring Details".

Enabling/Disabling Sensoface

Sensoface is enabled and disabled in the **Sensor Data** submenu:



Parameter Setting ▶ [I] [II] [Sensor] ▶ Sensor Data

Note: After a calibration, a smiley is always displayed for confirmation, even if Sensoface is disabled.

Adjusting Sensor Monitoring

Note: Function active for digital sensors.

01. **Sensor Data** ▶ **Sensor Monitoring Details** .
02. Open a sensor parameter, e.g., **Cell Constant** .
03. Set **Monitoring** of the cell constant to automatic or individual.
04. If you select "Individual": The nominal cell constant and the min/max limits can be entered.
05. In the **Message** menu item, select whether and how an exceeded limit is to be displayed:

Off	No message.
Failure	A Failure message is shown in off-limit conditions; the corresponding NAMUR icon  is displayed. If "Display Color NE107" is selected, the measurement display is shown with red backlighting.
Maintenance	A Maintenance Required message is shown in off-limit conditions; the corresponding NAMUR icon  is displayed. If "Display Color NE107" is selected, the measurement display is shown with blue backlighting.
06. Set the sensor monitoring details for further sensor data, e.g., Sensocheck, sensor operating time, or CIP/SIP counter.
07. Using the **left softkey: Back**, confirm the sensor monitoring settings and adjust further parameters.
or
Using the **right softkey: Back to Meas.**, confirm the sensor monitoring settings and end the function check (HOLD).

CIP/SIP Counters

CIP/SIP counters are available for the following conductivity sensor types:

- Memosens toroidal conductivity sensors

CIP/SIP cycles are used to clean or sterilize process-wetted parts in the process. Depending on the application, either one chemical (alkaline solution, water) or several chemicals (alkaline solution, water, acidic solution, water) are used.

- CIP temperature > 55 °C/131 °F
- SIP temperature > 115 °C/239 °F

The cleaning (cleaning in place) and sterilization (sterilization in place) cycles are counted to measure the load on the sensor, e.g., in biotechnology applications.

Note: If measurements are generally taken at high temperatures (> 55 °C/131 °F), the counters should be switched off.



When a CIP/SIP counter is switched on, a maximum number of cycles can be entered. As soon as the counter has reached the specified value, a Maintenance Required message is triggered and the NAMUR icon  is displayed; the measurement display is shown with blue backlighting (display color: NE107).

Note: A CIP or SIP cycle is only entered into the logbook 2 hours after the start to ensure that the cycle is complete.

Note: With Memosens sensors, an entry is also made in the sensor.

Adjusting CIP/SIP Counters

01. **Sensor Monitoring Details** ▶ CIP Counter / SIP Counter
02. **Monitoring** : Off or individual
03. If you select "Individual": Enter the maximum number of CIP/SIP cycles.
04. In the **Message** menu item, select whether and how an exceeded limit is to be displayed:

Off	No message.
Failure	A Failure message is shown in off-limit conditions; the corresponding NAMUR icon  is displayed. If "Display Color NE107" is selected, the measurement display is shown with red backlighting.
Maintenance	A Maintenance Required message is shown in off-limit conditions; the corresponding NAMUR icon  is displayed. If "Display Color NE107" is selected, the measurement display is shown with blue backlighting.

6.11.2 Calibration Presettings

The calibration presettings can be defined in the parameter settings or adjusted directly in the Calibration menu prior to the calibration.

Calibration Mode: Presetting of calibration mode, e.g., Automatic, Manual, Product Calibration, Zero Point, Installation Factor, Data Entry, Temperature

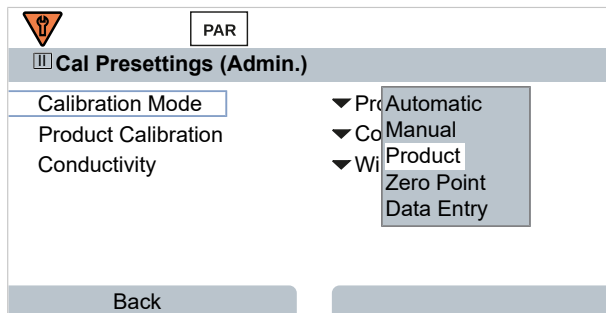

Further options are available depending on the calibration mode.

Automatic	Product Calibration	
Selection of calibration solution	Conductivity:	Selection with/without temperature compensation
	Concentration: ¹⁾	Selection of medium

Calibration presettings can be changed in the **Cal Presettings** submenu:

Parameter Setting ▶ **[I] [II] ... Cond** ▶ **Cal Presettings**

¹⁾ First enable TAN option FW-E009. → *Concentration Determination (FW-E009)*, p. 237

6.11.3 Temperature Compensation of Process Medium

Note: If temperature compensation of the process medium is enabled, "TC" is shown on the display in measuring mode.

The following are available for temperature compensation:

- Off
- Linear (enter temperature coefficient TC)
- EN 27888 (natural waters)
- Ultrapure water (with different trace impurities)

Trace Impurities in Ultrapure Water

NaCl	Neutral ultrapure water, for conductivity measurement in water processing downstream of gravel bed filter
HCl	Acidic ultrapure water, for conductivity measurement downstream of cation filter
NH ₃	Ammoniacal ultrapure water
NaOH	Alkaline ultrapure water

Settings can be changed in the **TC Process Medium** submenu:

Parameter Setting ▶ [I] [II] ... Cond ▶ **TC Process Medium**

6.11.4 Concentration (TAN Option FW-E009)

With TAN option FW-E009, the substance concentration in percent by weight (wt%) can be determined for H₂SO₄, HNO₃, HCl, NaOH, NaCl, and Oleum from the measured conductivity and temperature values. A custom solution can also be specified.

The menu is only shown if the TAN option is activated.

Parameter Setting ▶ [I] [II] ... Cond(I) ▶ **Concentration**

See also

→ *Concentration Determination (FW-E009), p. 237*

6.11.5 TDS Function

TDS (total dissolved solids) = weight of dissolved solids that influence conductivity

The TDS function provides a quick way of determining the evaporation residue of water. A TDS factor must be entered for this purpose.

The factor establishes a simple linear relationship between measured conductivity and evaporation residue. It is dependent on the composition of the medium and must be empirically determined by the user.

6.11.6 USP Function

Monitoring Ultrapure Water in the Pharmaceutical Industry

The conductivity of ultrapure water in the pharmaceutical industry can be monitored online in accordance with the guideline "USP" (U.S. Pharmacopeia), Annex 5, Section 645 "Water Conductivity". The conductivity is measured without temperature compensation and is compared with limits. The water is usable without any further testing when the conductivity is below the USP limit.

Configuring the USP Function



The USP value can be configured as a process variable USP% for output (display, current output, limit, measurement recorder)

Settings can be changed in the **USP** submenu:

Parameter Setting ▶ [I] [II] ... Cond(I) ▶ USP

Reduced limit: The USP limit can be reduced down to 10 %.

Monitoring: Select whether and how an exceeded limit is to be displayed.

Off	No message, but the parameter is still shown in the Diagnostics menu.
Failure	A Failure message is shown in off-limit conditions; the corresponding NAMUR icon  is displayed. If "Display Color NE107" is selected, the measurement display is shown with red backlighting.
Maintenance	A Maintenance Required message is shown in off-limit conditions; the corresponding NAMUR icon  is displayed. If "Display Color NE107" is selected, the measurement display is shown with blue backlighting.

USP Function: Specifying a Relay Contact

The USP function can also be assigned to a relay contact:

Parameter setting ▶ Inputs/Outputs ▶ Relay Contacts ▶ Contact K... → Usage: USP Output, p. 64

Display of the USP Function in the Diagnostics Menu

Diagnostics ▶ [I] [II] ... Cond(I) ▶ USP Function

Display of the USP limit, the reduced limit, and conductivity.

6.11.7 Messages

All values determined by the measuring module or sensor can generate messages.

Messages can be configured for the following process variables:

- Conductivity
- Resistivity
- Concentration (with TAN option FW-E009)
- Temperature
- Salinity

Configuring Messages

Process variable limits for the monitoring range can be selected in the **Messages** submenu:



Parameter Setting ▶ [I] [II] [Sensor] ▶ Messages ▶ Messages [Process Variable] ▶ Monitoring

- Max. Device Limits: Messages are generated when the process variable is outside the measuring range. The “failure” or “out of specification” icons are shown; the corresponding relay contact is enabled. The current outputs can signal a 22-mA message (user-defined).
- Variable Limits: Upper and lower limits at which a message is generated can be defined for the “Failure” and “Out of Specification” messages.

Note: If display color NE107 is selected in Parameter Setting (factory setting), measured values are backlit in accordance with their NAMUR color when NAMUR messages are available.

Parameter Setting ▶ General ▶ Display

Displaying Messages

01. Go to the Diagnostics menu if the “failure” , “maintenance required” , or “out of specification”  icons are flashing on the display: Menu Selection ▶ Diagnostics ▶ Message List
 - ✓ All active messages are displayed in the **Message List** menu item with the following information: Error number, type (failure, maintenance required, out of specification), channel, message text.
 02. You can scroll forward and backward using the **up/down arrow keys**.
- The error message disappears from the display around 2 s after the error is cleared.
- An overview of message texts with notes on troubleshooting can be found in the “Troubleshooting” chapter. → *Malfunction States, p. 161*

6.12 Dual Conductivity Measurement

Analog 2-Channel Conductivity Measurement with the MK-CC065N Measuring Module

The module can operate with two 2-electrode conductivity sensors, each with a Pt1000 temperature probe.

Select the MK-CC065N measuring module:

Parameter Setting ▶ Sensor Selection [I] [II] ▶ Sensor Selection [II]

Module: MK-CC
 Mode: Analog

Parameter Setting ▶ [II] Analog Cond-Cond

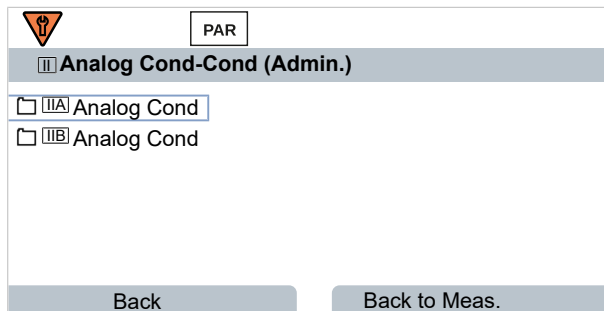

Parameter setting → *Conductivity (Contacting) Process Variable, p. 81*

2-Channel Conductivity Measurement with Memosens

A 2-channel conductivity measurement can also be performed with two Memosens sensors or one Memosens and one analog sensor. In this case, a Memosens sensor is directly connected to the device, a second conductivity sensor via the MK-COND025N or MK-MS095N modules.

Parameter setting → *Conductivity (Contacting) Process Variable, p. 80*

Layout of the Measuring Point

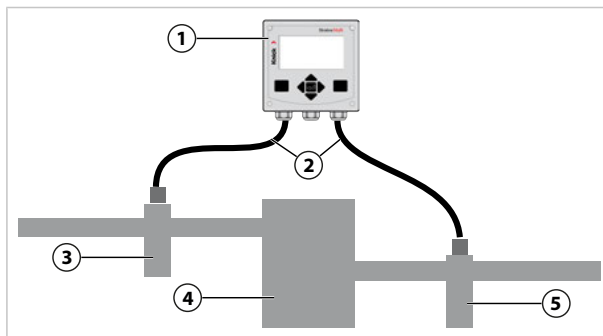

1 Stratos Multi	4 Cation exchanger
2 Max. connection length 3 m	5 Outlet: Conductivity sensor B with fitting
3 Inlet: Conductivity sensor A with fitting	

Calculation Blocks (TAN Option FW-E020)

With TAN option FW-E020, "Calculation Blocks", the measured conductivity values can be converted into new variables. → *Calculation Blocks (FW-E020), p. 244*

6.13 Oxygen Process Variable

Note: Function check (HOLD) is active.

Note: After changing the process variable or measuring mode, Stratos Multi retains its settings but needs to be reconfigured.

Note: Oxygen measurements in low oxygen concentrations require TAN option FW-E015.

Selecting a Memosens Oxygen Sensor

Parameter Setting ▶ Sensor Selection [I] [II] ▶ Sensor Selection [I]

Selection of the Memosens oxygen sensor connected to the RS-485 interface (terminals 1 ... 5):

Process variable: Auto or oxygen
 Mode: Memosens
 Functionality: Amperometric

Selecting a Second Memosens Oxygen Sensor

Parameter Setting ▶ Sensor Selection [I] [II] ▶ Sensor Selection [II]

Selection of a second Memosens oxygen sensor connected to the MK-MS095N measuring module:

Module: MK-MS
 Process variable: Oxygen
 Mode: Memosens
 Functionality: Amperometric

Adjustable Parameters for Memosens Oxygen Sensors Parameter Setting ▶ [I] [II] Memosens Oxy

Input Filter	Pulse Suppression	Suppression of interference pulses: Off, Weak, Medium, Strong
	Input Filter	Setting in seconds
Sensor Data → <i>Sensor Data, p. 99</i>	Measure in	Liquids, Gases
	Sensoface	Enable/disable display of Sensoface messages and icons.
	Sensor Monitoring Details	Option to enter individual limits for monitoring separate parameters. Disable Sensocheck sensor monitoring or select whether Sensocheck should generate Failure or Maintenance Required messages. Option to enter individual limits before a message for response time, sensor wear, sensor operating time, SIP counter is triggered.
Cal Presettings	Presetting of the calibration mode and calibration timer. → <i>Calibration Presettings, p. 102</i>	
Pressure Correction	Manual input of pressure during measurement and calibration or pressure correction via AO 1. → <i>Pressure Correction, p. 102</i>	
Salinity Correction	Salinity, Chlorinity, Conductivity → <i>Salinity Correction, p. 103</i>	
Messages	Enable/disable messages for the separate process variables, or specify individual limits. → <i>Messages, p. 103</i>	

Selecting the SE740 Optical Oxygen Sensor (LDO)

Parameter Setting ▶ Sensor Selection [I] [II] ▶ Sensor Selection [I]

Selection of the SE740 optical oxygen sensor connected to the RS-485 interface (terminals 1 ... 6):

Process variable: Auto or oxygen
 Mode: Other digital
 Functionality: SE740

Note: The voltage at terminal 6 (Power Out) is automatically set to 14 V when using the SE740 optical oxygen sensor. The Power Out menu item is not available.

Adjustable Parameters for the SE740 Optical Oxygen Sensor [Parameter Setting](#) ▶ [\[I\] Digital Oxy](#)

Input Filter	Pulse Suppression	Suppression of interference pulses: off, weak, medium, strong
	Input Filter	Setting in seconds
Sensor Data → <i>Sensor Data</i> , p. 99	Measure in	Liquids, gases
	Sensoface	Enable/disable display of Sensoface messages and icons.
	Sensor Monitoring Details	Select whether a failure or maintenance required message is triggered if the range of the Stern-Volmer constant and phase angle is exceeded. Disable Sensocheck sensor monitoring or select whether Sensocheck should generate failure or maintenance required messages. Option to enter individual limits before a message for sensor wear, sensor operating time, CIP counter, O ₂ measurement with CIP/SIP, autoclaving counter is triggered.
Cal. Presettings	Presetting of the calibration mode and calibration timer. → <i>Calibration Presettings</i> , p. 102	
Pressure Correction	Manual input of pressure during measurement and calibration or pressure correction via AO 1. → <i>Pressure Correction</i> , p. 102	
Salinity Correction	Salinity, chlorinity, conductivity → <i>Salinity Correction</i> , p. 103	
Messages	Enable/disable messages for the separate process variables, or specify individual limits. → <i>Messages</i> , p. 103	

Selecting a Digital ISM Oxygen Sensor (TAN Option FW-E053)

Parameter Setting ▶ Sensor Selection [I] [II] ▶ Sensor Selection [II]

Selection of an ISM oxygen sensor connected to the MK-OXY046N measuring module:

Module: MK-OXY
 Mode: ISM

Adjustable Parameters for ISM Oxygen Sensors [Parameter Setting](#) ▶ [\[II\] ISM Oxy](#)

Input Filter	Pulse Suppression	Suppression of interference pulses: Off, Weak, Medium, Strong
	Input Filter	Setting in seconds
Sensor Data → <i>Sensor Data</i> , p. 99	Measure in	Liquids, Gases
	Sensoface	Enable/disable display of Sensoface messages and icons.
	Sensor Monitoring Details	Option to enter individual limit values for monitoring slope, zero point, Sensocheck impedance, response time, sensor operating time, TTM maintenance timer, DLI lifetime indicator, CIP/SIP counters, autoclaving counter, membrane body replacement, interior body replacement. Set whether to generate Failure or Maintenance Required messages if exceeded.
Cal Presettings	Presetting of the calibration mode and calibration timer. → <i>Calibration Presettings</i> , p. 102	
Pressure Correction	Manual input of pressure during measurement and calibration or pressure correction via AO 1. → <i>Pressure Correction</i> , p. 102	

Salinity Correction	Salinity, Chlorinity, Conductivity → <i>Salinity Correction, p. 103</i>
Messages	Enable/disable messages for the separate process variables, or specify individual limits. → <i>Messages, p. 103</i>

More information on the use of ISM sensors → *Digital ISM Sensors (FW-E053), p. 248*

Selecting an Analog Oxygen Sensor

Parameter Setting ▶ Sensor Selection [I] [II] ▶ Sensor Selection [II]

Selection of an oxygen sensor connected to the MK-OXY046N measuring module:

Module: MK-OXY
Mode: Analog

Adjustable Parameters for Analog Oxygen Sensors Parameter Setting ▶ [II] Analog Oxy

Input Filter	Pulse Suppression	Suppression of interference pulses: Off, Weak, Medium, Strong
	Input Filter	Setting in seconds
Sensor Data → <i>Sensor Data, p. 99</i>	Measure in	Liquids, Gases
	Sensor Type	Standard or Other
	Temperature Detector	NTC 22kΩ, NTC 30kΩ
	Sensor Polarization	Automatic or individual If you select "Individual", separate values for polarization can be entered during measurement and calibration.
	Membrane Compensation	If "Other Sensor Type" is selected
	Sensoface	Enable/disable display of Sensoface messages and icons.
	Sensor Monitoring Details	Option to enter individual limits for monitoring zero point and slope. Disable Sensocheck sensor monitoring or select whether Sensocheck should generate Failure or Maintenance Required messages. Option to enter individual limits before a message for response time is triggered.
Cal Presettings	Presetting of the calibration mode and calibration timer. → <i>Calibration Presettings, p. 102</i>	
Pressure Correction	Manual input of pressure during measurement and calibration or pressure correction via AO 1. → <i>Pressure Correction, p. 102</i>	
Salinity Correction	Salinity, Chlorinity, Conductivity → <i>Salinity Correction, p. 103</i>	
Messages	Enable/disable messages for the separate process variables, or specify individual limits. → <i>Messages, p. 103</i>	

6.13.1 Sensor Data

Display Example for an Analog Oxygen Sensor

Parameter	Value
Measure in	Liquids
Sensor Type	NTC 22kΩ
Temperature Probe	NTC 22kΩ
Sensor Polarization	Auto
Polariz. During Meas	-675 mV
Polariz. During Cal	-675 mV

01. Select whether to measure in liquids or gases.
02. If measuring in gases: Enter the relative humidity of the process medium.
03. If using an analog sensor: Select the sensor type and the used temperature probe.
04. If using an analog sensor: Select whether the polarization voltage should be selected automatically or individually during measurement and calibration.

Note: The preset polarization voltage of -675 mV is appropriate for most measurements.

Settings can be changed in the **Sensor Data** submenu:

Parameter Setting ▶ [I] [II] ... Oxy ▶ Sensor Data

Sensoface

The Sensoface icons provide the user with diagnostic information on wear and required maintenance of the sensor. In measuring mode, an icon (happy, neutral, or sad smiley) is shown on the display to reflect the continuous monitoring of the sensor parameters.

You can configure the current outputs so that a Sensoface message generates a 22-mA error signal:

Parameter Setting ▶ Inputs/Outputs ▶ Current Outputs ▶ Current Output I... ▶ Behavior During Messages

The Sensoface message can also be output via a relay contact:

Parameter Setting ▶ Inputs/Outputs ▶ Relay Contacts ▶ Contact K... → Usage: Sensoface, p. 64

Sensoface monitors the oxygen sensor for slope, zero point, response time, and sensor wear. Sensoface is displayed when Sensocheck has been enabled during parameter setting.

Enabling/Disabling Sensoface



Sensoface is enabled and disabled in the **Sensor Data** submenu:

Parameter Setting ▶ [I] [II] [Sensor] ▶ Sensor Data

Note: After a calibration, a smiley is always displayed for confirmation, even if Sensoface is disabled.

Adjusting Sensor Monitoring

01. **Sensor Data** ▶ **Sensor Monitoring Details** .
02. Open a sensor parameter, e.g., **Slope** .
03. Set **Monitoring** of the slope to automatic or individual.
04. If you select "Individual": The nominal slope and the min/max limits can be entered.
05. In the **Message** menu item, select whether and how an exceeded limit is to be displayed:

Off	No message, but the parameter is still shown in the Diagnostics menu and on the sensor diagram.
Failure	A Failure message is shown in off-limit conditions; the corresponding NAMUR icon  is displayed. If "Display Color NE107" is selected, the measurement display is shown with red backlighting.
Maintenance	A Maintenance Required message is shown in off-limit conditions; the corresponding NAMUR icon  is displayed. If "Display Color NE107" is selected, the measurement display is shown with blue backlighting.
06. Set the sensor monitoring details for other sensor data, e.g., zero point, Sensocheck, response time, sensor wear, or sensor operating time.
07. Using the **left softkey: Back**, confirm the sensor monitoring settings and adjust further parameters.
or
Using the **right softkey: Back to Meas.**, confirm the sensor monitoring settings and end the function check (HOLD).

CIP/SIP Counters

CIP/SIP counters are available for the following oxygen sensor types:

	Memosens Oxy	SE740	ISM Oxy ¹⁾
CIP counter		+	+
SIP counter	+		+

CIP/SIP cycles are used to clean or sterilize process-wetted parts in the process. Depending on the application, either one chemical (alkaline solution, water) or several chemicals (alkaline solution, water, acidic solution, water) are used.

- CIP temperature > 55 °C/131 °F
- SIP temperature > 115 °C/239 °F

The cleaning (cleaning in place) and sterilization (sterilization in place) cycles are counted to measure the load on the sensor, e.g., in biotechnology applications.

Note: If measurements are generally taken at high temperatures (> 55 °C/131 °F), the counters should be switched off.

When a CIP/SIP counter is switched on, a maximum number of cycles can be entered. As soon as the counter has reached the specified value, a Maintenance Required message is triggered and the NAMUR icon  is displayed; the measurement display is shown with blue backlighting (display color: NE107).



Note: A CIP or SIP cycle is only entered into the logbook 2 hours after the start to ensure that the cycle is complete.

Note: With Memosens sensors, an entry is also made in the sensor.

¹⁾ With TAN option FW-E053

Adjusting CIP/SIP Counters



01. [Sensor Monitoring Details](#) ▶ [CIP Counter](#) / [SIP Counter](#)
02. [Monitoring](#) : Off or individual
03. If you select "Individual": Enter the maximum number of CIP/SIP cycles.
04. In the [Message](#) menu item, select whether and how an exceeded limit is to be displayed:

Off	No message.
Failure	A Failure message is shown in off-limit conditions; the corresponding NAMUR icon  is displayed. If "Display Color NE107" is selected, the measurement display is shown with red backlighting.
Maintenance	A Maintenance Required message is shown in off-limit conditions; the corresponding NAMUR icon  is displayed. If "Display Color NE107" is selected, the measurement display is shown with blue backlighting.

O₂ Measurement with SIP

When using the SE740 optical oxygen sensor, the temperature can be monitored during the CIP process. When the preset cut-off temperature is exceeded, the sensor automatically stops the oxygen measurement to extend the life of the membrane. The measured oxygen value is frozen, the temperature continues to be measured.

01. [Sensor Monitoring Details](#) ▶ [O2 Meas. with CIP](#) .
02. [Monitoring](#) : Automatic or individual
03. If you select "Individual": Enter the maximum cut-off temperature.
04. In the [Message](#) menu item, select whether and how an exceeded limit is to be displayed:

Off	No message, but the parameter is still shown in the Diagnostics menu and on the sensor diagram.
Failure	A Failure message is shown in off-limit conditions; the corresponding NAMUR icon  is displayed. If "Display Color NE107" is selected, the measurement display is shown with red backlighting.
Maintenance	A Maintenance Required message is shown in off-limit conditions; the corresponding NAMUR icon  is displayed. If "Display Color NE107" is selected, the measurement display is shown with blue backlighting.

Settings can be changed in the [Sensor Monitoring Details](#) submenu:

[Parameter Setting](#) ▶ [\[I\] \[II\] ... Oxy](#) ▶ [Sensor Data](#) ▶ [Sensor Monitoring Details](#)

Autoclaving Counter

An autoclaving counter is available for the following oxygen sensor types:



- SE740 optical oxygen sensor
- ISM oxygen sensors (with TAN option FW-E053)

Autoclaving cycles are counted to help measure the load on the sensor.

Adjusting the Autoclaving Counter

01. [Sensor Monitoring Details](#) ▶ [Autoclaving Counter](#)
02. [Monitoring](#) : Off or individual
03. If you select "Individual": Enter the maximum number of autoclaving cycles.

04. In the **Message** menu item, select whether and how an exceeded limit is to be displayed:

- Off No message.
- Failure A Failure message is shown in off-limit conditions; the corresponding NAMUR icon  is displayed. If "Display Color NE107" is selected, the measurement display is shown with red backlighting.
- Maintenance A Maintenance Required message is shown in off-limit conditions; the corresponding NAMUR icon  is displayed. If "Display Color NE107" is selected, the measurement display is shown with blue backlighting.

After each autoclaving process, the autoclaving counter must be manually incremented in the device's Maintenance menu:

Maintenance ▶ [I][II] [Sensor] ▶ Autoclaving Counter

6.13.2 Calibration Presettings

The calibration presettings can be defined in the parameter settings or adjusted directly in the Calibration menu prior to the calibration.

Calibration Mode : Presetting of calibration mode, e.g., in air, in water, data entry, product calibration, zero calibration, temperature

If you select "Product Calibration" mode, you must also select the measured value: Saturation %air, concentration (gas), partial pressure

Calibration Timer : When a preset calibration interval expires, the calibration timer generates a message text to indicate the need for calibration. If "Auto" is selected, the interval is set to 720 h. If "Individual" is selected, you can select a custom interval.

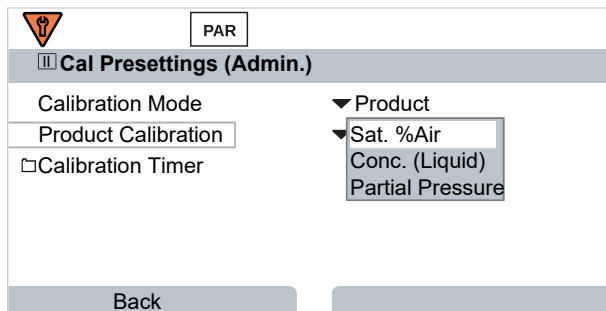

Settings can be changed in the **Cal Presettings** submenu:

Parameter Setting ▶ [I] [II] ... Oxy ▶ Cal Presettings

Note: If Sensoface is enabled, a neutral smiley is displayed once 80 % of the interval has expired. Once the entire interval has expired, a sad smiley is shown, a Maintenance Required message is generated, and the corresponding NAMUR icon  is displayed and the measurement display is shown with blue backlighting (display color: NE107). If the current outputs are configured accordingly, a 22-mA error signal is generated.

6.13.3 Pressure Correction

The pressure used for measurement or calibration can be manually specified (factory setting 1013 mbar); alternatively, the value of an external pressure transmitter can be provided via PROFINET AO 1 (analog output). → *PROFINET Commands, p. 111*

Settings can be changed in the **Pressure Correction** submenu:

Parameter Setting ▶ [I] [II] ... Oxy ▶ Pressure Correction

6.13.4 Salinity Correction

The solubility of oxygen in water depends on its salinity. The correction is made by either directly entering the salinity in g/kg, the chlorinity in g/kg, or the conductivity in $\mu\text{S}/\text{cm}$, and the temperature.

Settings can be changed in the **Salinity Correction** submenu:

Parameter Setting ▶ [I] [II] ... Oxy ▶ Salinity Correction

6.13.5 Messages

All values determined by the measuring module or sensor can generate messages.

Messages can be configured for the following process variables:

- Saturation %air
- Saturation %O₂
- Concentration
- Partial pressure
- Temperature
- Process pressure

Configuring Messages

Process variable limits for the monitoring range can be selected in the **Messages** submenu:



Parameter Setting ▶ [I] [II] [Sensor] ▶ Messages ▶ Messages [Process Variable] ▶ Monitoring

- Max. Device Limits: Messages are generated when the process variable is outside the measuring range. The “failure” or “out of specification” icons are shown; the corresponding relay contact is enabled. The current outputs can signal a 22-mA message (user-defined).
- Variable Limits: Upper and lower limits at which a message is generated can be defined for the “Failure” and “Out of Specification” messages.

Note: If display color NE107 is selected in Parameter Setting (factory setting), measured values are backlit in accordance with their NAMUR color when NAMUR messages are available.

Parameter Setting ▶ General ▶ Display

Displaying Messages

01. Go to the Diagnostics menu if the “failure” , “maintenance required” , or “out of specification”  icons are flashing on the display: **Menu Selection ▶ Diagnostics ▶ Message List**

- ✓ All active messages are displayed in the **Message List** menu item with the following information: Error number, type (failure, maintenance required, out of specification), channel, message text.

02. You can scroll forward and backward using the **up/down arrow keys**.

The error message disappears from the display around 2 s after the error is cleared.

An overview of message texts with notes on troubleshooting can be found in the “Troubleshooting” chapter. → *Malfunction States*, p. 161

6.14 PROFINET

6.14.1 System Integration

Initial commissioning

PROFINET devices are identified in the network using the following parameters:

IP address, MAC address, and device name (name of station).

- IP address on delivery: 0.0.0.0
- For the MAC address, see the terminal plate.
- Device name (name of station) not set on delivery (empty).

IP configuration and device name (name of station) must be set using a suitable engineering tool.

Configuration with the Siemens TIA Portal is specified on the following pages.

Application	Tool
Integration in PROFINET system	Engineering tool
Device name and IP address	Engineering tool
Device parameter setting	Local device
Back up/save device configuration	Data Card ZU1080-S-N-D

Installing the GSDML File

A PROFINET device master file (GSDML file) is required for system integration.

The latest version of the GSDML file is available in the downloads section of the Knick website.

The procedure for installing the GSDML file varies depending on the engineering tool used. The Simatic TIA Portal V15 is used in the example.

01. Open the **Extras** ▶ **Manage General Station Description Files (GSD)** menu.
02. **Browse** button: Select the directory containing the GSDML file to be installed.
03. Select the GSDML file from the list.
04. **Install** button: The GSDML file is installed and added to the hardware catalog.

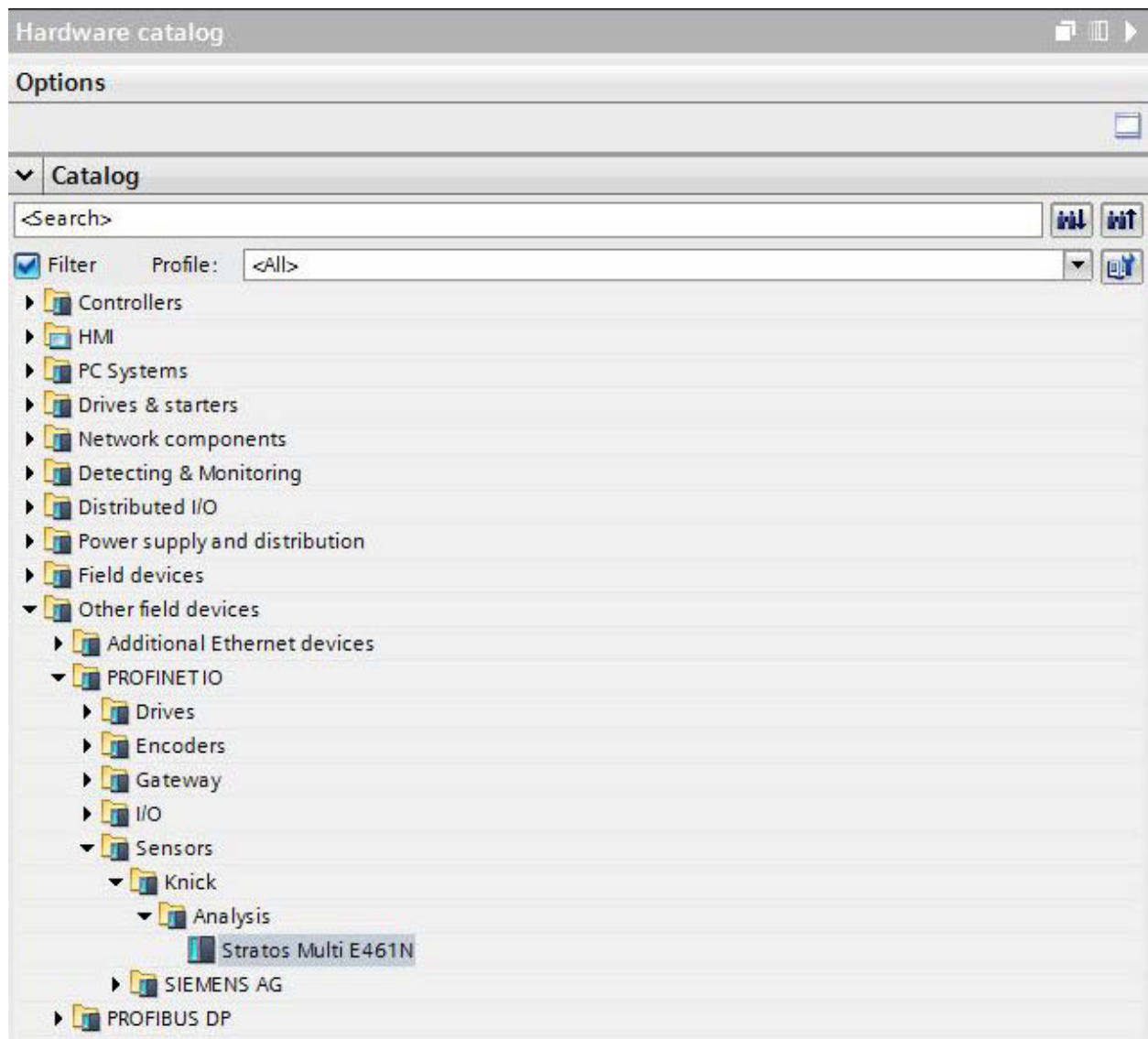

Configuration in the TIA Portal

01. Select the following in the Stratos Multi E461N hardware catalog:
Other Field Devices ▶ PROFINET IO ▶ Sensors ▶ Knick ▶ Analysis : "Stratos Multi E461N"
02. Drag and drop "Stratos Multi E461N" into the network view and position it next to the CPU icon.
03. Assign the Stratos Multi E461N to the PROFINET IO controller:
 Click on the interface of the Stratos Multi E461N and, keeping the mouse button depressed, connect it to the CPU icon.
04. Double-click on "Stratos Multi E461N": The device properties are shown in the inspector window.
05. Configure the Stratos Multi E461N PROFINET interface:
 Set the IP address and PROFINET device name.

Note: The PROFINET controller and the field device must be in the same subnet.

The screenshot shows the Siemens TIA Portal software interface. The top window displays a network topology with a CPU 1511C-1 PN connected to a Knick Stratos Multi E461N device via a subnet labeled PN/E_1. The bottom window shows the 'Properties' dialog for the device, with the 'Ethernet addresses' tab selected. The 'Interface networked with' dropdown is set to 'PN/E_1'. Under 'IP protocol', the 'Set IP address in the project' option is selected, with IP address 192.168.16.1 and subnet mask 255.255.255.0. Under 'PROFINET', the 'Generate PROFINET device name automatically' checkbox is checked, and the device name is 'stratos-multi-e461n'.

Assigning the Device Name and IP address Online

01. Connect the device to the PROFINET network.
02. TIA Portal: **Project Navigation** ▶ **Devices** ▶ **Online Access** .
03. Select the device's network interface.
04. Double-click on "Update Accessible Devices":
 - ✓ Accessible devices are shown with their MAC addresses.
05. Select the device.
06. **Online & Diagnostics** ▶ **Functions** menu: Assign the IP address and device name.
07. Then download the project and check whether communication functions correctly.

6.14.2 Changing the Device

Using the neighborhood detection function, the control system assigns the PROFINET device name and the IP address to the newly added device (Stratos Multi E461N).

Note: If the device is replaced, all PROFINET settings, but none of the other device parameter settings, are automatically applied. Before replacing the device, save the configuration on a ZU1080-S-N-D Data Card.

6.14.3 Resetting the Device

Resetting the Device Parameters

In the Stratos Multi E461N device menu:

Parameter Setting ▶ System Control ▶ Restore Factory Settings

The reset function in the device menu does not reset the PROFINET network settings.

In the TIA Portal:

Functions ▶ Reset to Factory Settings

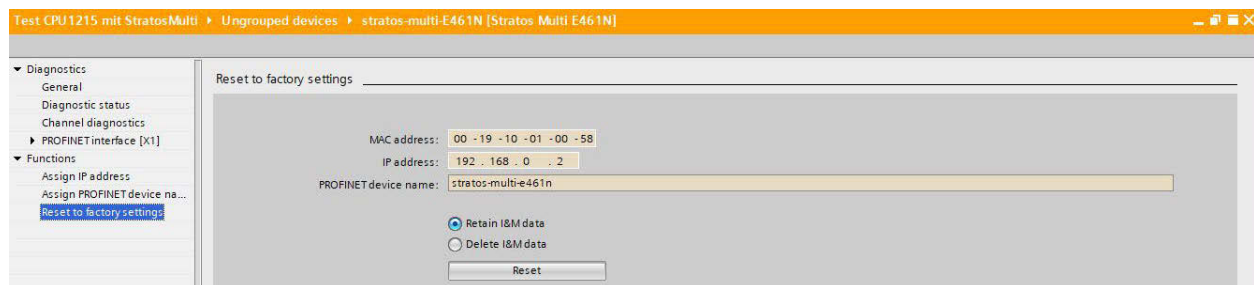

The reset function via PROFINET does not reset the Stratos Multi to its factory settings.

Resetting the PROFINET Network Settings

In the engineering tool using the DCP service command RESET_COMMUNICATION_PARAMETER.

6.14.4 Function Blocks (AI, AO, DO)

The device provides 20 analog input blocks (AI 1 ... AI 20), one analog output block (AO1), and two digital output blocks (DO1, DO2).

The function blocks have fixed positions in the GSDML file and cannot be removed. This makes it possible to add additional process variables to the cyclic I/O data in the device menu without having to adjust the PROFINET project with the engineering tool.

6.14.5 Cyclic Data Transfer

Cyclic data transfer has two transport directions:

Input Data

Data transfer from the field device (device) to the process control system (controller): Input data is provided by the analog input function blocks.

Output Data

Data transfer from the process control system (controller) to the field device (device): Output data is processed by the analog output and digital output function blocks.

Coding Cyclic Commands (I/O Data)

Input frame: (device -> controller): 140 bytes

AIx (channel n sensor X)		IOPSx	IOCSx
Value	Status		
Float	Unsigned8	Unsigned8	Unsigned8

AIx: 1 ... 20

Channel n: 1, 2

Sensor X: A, B

Output frame: (controller -> device): 15 bytes

AO1		IOPS1	IOCS1
Value	Status		
Float	Unsigned8	Unsigned8	Unsigned8
DO1 (relay contact 1)		IOPS2	IOCS2
Value	Status		
Unsigned8	Unsigned8	Unsigned8	Unsigned8
DO2 (relay contact 2)		IOPS3	IOCS3
Value	Status		
Unsigned8	Unsigned8	Unsigned8	Unsigned8

6.14.6 Configuring the Measured Values

Stratos Multi E461N provides 20 analog input blocks (AI1 ... AI20).

The measured values to be transmitted by an AI are assigned on the device:

01. [Parameter Setting](#) ▶ [Administrator Level](#) ▶ [PROFINET](#) ▶ [Measured Values](#)
02. Select process variables for AI1 to AI20.

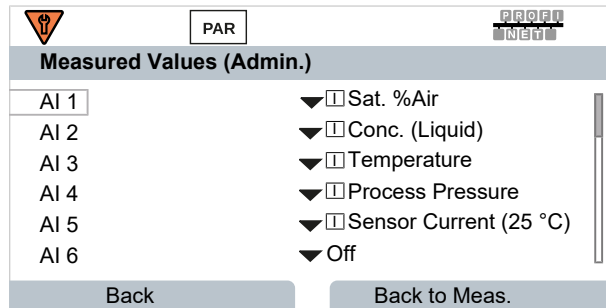

The measured values available are determined by the connected sensor and the configuration.

When configuring the measured values in the control system, a measured value must be selected for AI1 to AI20. Since the measured values are not automatically recognized by the control system, the device measured values AI1 to AI20 must be correctly assigned to the control system.

Available Measured Values

Note: The available selection depends on the sensor type used.

Data Source: pH/ORP Measurement

Measured Values	Unit of Measure	State
pH value	pH	Variable
ORP	mV	Variable
Temperature	°C	Variable
pH voltage	mV	Variable
rH value		Variable
Glass impedance	Ω	Variable
Reference impedance	Ω	Variable
pH zero point	pH	Constant
pH slope	mV/pH	Constant
ISFET operating point	mV	Constant
ORP offset	%	Constant
Sensoface		Constant
Calibration timer	h	Variable
Wear	%	Variable
Remaining lifetime	d	Variable
TTM maintenance timer	d	Variable
DLI lifetime indicator	h	Variable
Operating time	d	Constant
SIP counter		Constant
CIP counter		Constant
Autoclaving counter		Constant

Data Source: Oxygen Measurement

Measured Values	Unit of Measure	State
Sat. %Air	%	Variable
Saturation %O ₂	%	Variable
Temperature	°C	Variable
Conc. (Liquid)	mg/l, µg/l, ppm, ppb	Variable
Conc. (Gas)	Vol%	Variable
Sensor current	nA	Variable
Partial pressure	mbar, mmHg	Variable
Sensor current (25 °C)	nA	Variable
Process pressure	mbar, kPa, psi	Variable
Oxy zero	nA	Constant
Oxy slope	nA	Constant
Stern Volmer C.		Constant
Phase angle	°	Constant
Sensoface		Constant
Calibration timer	h	Variable
Wear	%	Variable
Membrane wear	%	Constant
Interior body wear	%	Constant
Impedance	Ω	Variable
TTM maintenance timer	d	Variable
DLI lifetime indicator	h	Variable
Operating time	d	Constant
SIP counter		Constant
CIP counter		Constant
Autoclaving counter		Constant

Data Source: Conductivity Measurement

Measured Values	Unit of Measure	State
Conductivity	S/cm	Variable
Temperature	°C	Variable
Salinity	‰	Variable
Concentration	%	Variable
Resistivity	MΩ·cm	Variable
USP value		Variable
TDS	mg/l	Variable
Conductance	MΩ·cm	Variable
Effective resistance		Variable
Cell constant	cm ⁻¹	Constant
Installation factor		Constant
Zero point		Constant
Sensoface		Constant
Operating time	d	Constant
SIP counter		Constant
CIP counter		Constant

6.14.7 PROFINET Commands

Note: The most significant byte is stored first, i.e., at the lowest memory address (big endian order).

Slot	Subslot	Index	Access	Parameter	Description
Device settings:					
0	4	0	rd/wr	LOCAL_OP_ENABLE	Local operation enable / KeyLock 1 byte ENUM Byte = 0 (key lock) Byte = 1 (local operation enable)
0	4	1	rd/wr	TEMPERATURE_UNIT	Unit of measure for temperature 1 byte ENUM Byte = 2 (°C) Byte = 3 (°F)
0	4	2	rd/wr	PRESSURE_UNIT	Unit of measure for pressure 1 byte ENUM Byte = 2 (mbar) Byte = 3 (kPa) Byte = 4 (psi)
0	4	3	rd/wr	CONCENTRATION_UNIT	Unit of measure for concentration 1 byte ENUM Byte = 5 (mg/l) Byte = 6 (ppm)
0	4	4	rd/wr	PARTIAL_PRESSURE_UNIT	Unit of measure for part. pressure 1 byte ENUM Byte = 7 (mbar) Byte = 8 (mmHg)
Device configuration:					
0	3	0	rd	DEVICE_CONFIG	Current module/sensor channel configuration in Stratos 4 byte flag register <u>Flag register[0]:</u> Flag 0: Channel 1 / sensor A Flag 1: Channel 1 / sensor B Flag 2: Channel 2 / sensor A Flag 3: Channel 2 / sensor B Flag 4-7: unused <u>Flag register[1]:</u> Flag 0-7: unused Channel / sensor present: Flag = 1 <u>Flag register[2]:</u> Flag 0: Sensor at channel 1 / sensor A Flag 1: Sensor at channel 1 / sensor B Flag 2: Sensor at channel 2 / sensor A Flag 3: Sensor at channel 2 / sensor B Flag 4-7: unused <u>Flag register[3]:</u> Flag 0-7: unused Sensor connected Flag = 1

Slot	Subslot	Index	Access	Parameter	Description
Input frame (cyclic data: device-> controller):					
1	1	-	rd	AI1	Measured value 1: from channel n sensor n 4 byte FLOAT – measured value 1 byte U8 – status
1	2	-	rd	AI2	Measured value 2: from channel n sensor n 4 byte FLOAT – measured value 1 byte U8 – status
1	3	-	rd	AI3	Measured value 3: from channel n sensor n 4 byte FLOAT – measured value 1 byte U8 – status
1	4	-	rd	AI4	Measured value 4: from channel n sensor n 4 byte FLOAT – measured value 1 byte U8 – status
1	5	-	rd	AI5	Measured value 5: from channel n sensor n 4 byte FLOAT – measured value 1 byte U8 – status
1	6	-	rd	AI6	Measured value 6: from channel n sensor n 4 byte FLOAT – measured value 1 byte U8 – status
1	7	-	rd	AI7	Measured value 7: from channel n sensor n 4 byte FLOAT – measured value 1 byte U8 – status
1	8	-	rd	AI8	Measured value 8: from channel n sensor n 4 byte FLOAT – measured value 1 byte U8 – status
1	9	-	rd	AI9	Measured value 9: from channel n sensor n 4 byte FLOAT – measured value 1 byte U8 – status
1	10	-	rd	AI10	Measured value 10: from channel n sensor n 4 byte FLOAT – measured value 1 byte U8 – status
1	11	-	rd	AI11	Measured value 11: from channel n sensor n 4 byte FLOAT – measured value 1 byte U8 – status
1	12	-	rd	AI12	Measured value 12: from channel n sensor n 4 byte FLOAT – measured value 1 byte U8 – status
1	13	-	rd	AI13	Measured value 13: from channel n sensor n 4 byte FLOAT – measured value 1 byte U8 – status
1	14	-	rd	AI14	Measured value 14: from channel n sensor n 4 byte FLOAT – measured value 1 byte U8 – status
1	15	-	rd	AI15	Measured value 15: from channel n sensor n 4 byte FLOAT – measured value 1 byte U8 – status
1	16	-	rd	AI16	Measured value 16: from channel n sensor n 4 byte FLOAT – measured value 1 byte U8 – status
1	17	-	rd	AI17	Measured value 17: from channel n sensor n 4 byte FLOAT – measured value 1 byte U8 – status

Slot	Subslot	Index	Access	Parameter	Description
1	18	-	rd	AI18	Measured value 18: from channel n sensor n 4 byte FLOAT – measured value 1 byte U8 – status
1	19	-	rd	AI19	Measured value 19: from channel n sensor n 4 byte FLOAT – measured value 1 byte U8 – status
1	20	-	rd	AI20	Measured value 20: from channel n sensor n 4 byte FLOAT – measured value 1 byte U8 – status
Output frame (cyclic data: controller -> device):					
3	1	-	wr	AO1	External process pressure measured value 4 byte FLOAT – measured value 1 byte U8 – status
4	1	-	wr	DO1	Relay contact 1 status: 1 byte U8 – value (0: passive, > 0: active) 1 byte U8 – status
4	2	-	wr	DO2	Relay contact 2 status: 1 byte U8 – value (0: passive, > 0: active) 1 byte U8 – status
Channel 1 sensor A sensor description:					
11	1	60	rd	SNS_DESC_1A	1A: Sensor ID 64 bytes ASCII Byte 0 ... 31: Sensor ID Byte 32 ... 63: Sensor serial number
Channel 1 sensor A product calibration:					
11	1	62	rd/wr	CAL_PRD_MODE_1A	1A: Product calibration mode 1 byte ENUM For oxygen only: Mode = 0: Standard (saturation in liquids) Mode = 1: Alternative (concentration in gases or liquids) Other process variables: Mode = 0: Standard
11	1	63	rd/wr	CAL_PRD_SAMPLE_1A	1A: Take sample value, cancel. 1 byte ENUM Sample = 0x00: No action (default). Sample = 0x01: Triggers step 1 product calibration. Sample = 0xA5: Cancels running product calibration.
11	1	64	rd	CAL_PRD_STORED_VAL_1A	1A: Query saved sample value. 4 byte FLOAT Sample value
11	1	65	rd/wr	CAL_PRD_TRUE_VAL_1A	1A: Transfer lab value, calculate calibration values. 4 byte FLOAT Lab value, triggers step 2 product calibration.

Slot	Subslot	Index	Access	Parameter	Description
11	1	66	rd	CAL_PRD_STEP_1A	1A: Current product calibration step 1 byte ENUM Step = 0 or 1: Product calibration not running. Step = 3: Sample value was taken. Step = 2, 4, 5: Intermediate states Step = 255: Product calibration not supported.
11	1	67	rd	CAL_CAL_RESULT_1A	1A: Calibration result 1 byte ENUM Result = 0: Successful Result = 1: Error or canceled
Channel 1 sensor B sensor description:					
11	2	60	rd	SNS_DESC_1B	1B: Sensor ID See sensor description channel 1 sensor A.
Channel 1 sensor B product calibration:					
11	2	62	rd/wr	CAL_PRD_MODE_1B	1B: Product calibration mode See product calibration channel 1 sensor A.
11	2	63	rd/wr	CAL_PRD_SAMPLE_1B	1B: Take sample value, cancel. See product calibration channel 1 sensor A.
11	2	64	rd	CAL_PRD_STORED_VAL_1B	1B: Read saved sample value. See product calibration channel 1 sensor A.
11	2	65	rd/wr	CAL_PRD_TRUE_VAL_1B	1B: Transfer lab value, calculate calibration values. See product calibration channel 1 sensor A.
11	2	66	rd	CAL_PRD_STEP_1B	1B: Current product calibration step See product calibration channel 1 sensor A.
11	2	67	rd	CAL_CAL_RESULT_1B	1B: Calibration result See product calibration channel 1 sensor A.
Channel 2 sensor A sensor description:					
12	1	60	rd	SNS_DESC_2A	2A: Sensor ID See sensor description channel 1 sensor A.
Channel 2 sensor A product calibration:					
12	1	62	rd/wr	CAL_PRD_MODE_2A	2A: Product calibration mode See product calibration channel 1 sensor A.
12	1	63	rd/wr	CAL_PRD_SAMPLE_2A	2A: Take sample value, cancel. See product calibration channel 1 sensor A.
12	1	64	rd	CAL_PRD_STORED_VAL_2A	2A: Read saved sample value. See product calibration channel 1 sensor A.
12	1	65	rd/wr	CAL_PRD_TRUE_VAL_2A	2A: Transfer lab value, calculate calibration values. See product calibration channel 1 sensor A.
12	1	66	rd	CAL_PRD_STEP_2A	2A: Current product calibration step See product calibration channel 1 sensor A.
12	1	67	rd	CAL_CAL_RESULT_2A	2A: Calibration result See product calibration channel 1 sensor A.

Slot	Subslot	Index	Access	Parameter	Description
Channel 2 sensor B sensor description:					
12	2	60	rd	SNS_DESC_2B	2B: Sensor ID See sensor description channel 1 sensor A.
Channel 2 sensor B product calibration:					
12	2	62	rd/wr	CAL_PRD_MODE_2B	2B: Product calibration mode See product calibration channel 1 sensor A.
12	2	63	rd/wr	CAL_PRD_SAMPLE_2B	2B: Take sample value, cancel. See product calibration channel 1 sensor A.
12	2	64	rd	CAL_PRD_STORED_VAL_2B	2B: Read saved sample value. See product calibration channel 1 sensor A.
12	2	65	rd/wr	CAL_PRD_TRUE_VAL_2B	2B: Transfer lab value, calculate calibration values. See product calibration channel 1 sensor A.
12	2	66	rd	CAL_PRD_STEP_2B	2B: Current product calibration step See product calibration channel 1 sensor A.
12	2	67	rd	CAL_CAL_RESULT_2B	2B: Calibration result See product calibration channel 1 sensor A.

6.14.8 Key Lock

A key lock activated via the process control system is indicated on the device by the following pop-up window: "Keys Locked by DCS". Message "F234 Key Lock is Active" also appears in the message list and in the logbook.

6.14.9 Diagnostics

Displaying Network Information

Menu Selection ▶ Diagnostics ▶ Network Information

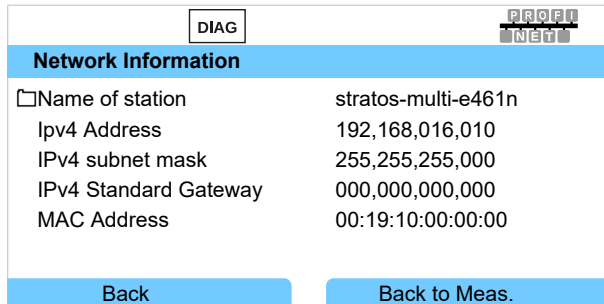

PROFINET Diagnostics

Menu Selection ▶ Diagnostics ▶ PROFINET Diagnostics

The values below indicate functioning PROFINET communication:

Stack state	0x000000FB
Last error	0x00000000
Phy link state	OK
Config state	Application
Comm state	Operate
Comm error	0x00000000

PROFINET Monitor

PROFINET monitor displays values transferred in cyclic data transfer.

Analog input: AIs transferred from the field device (device) to the process control system (controller):







Analog output: AOs transferred from the process control system (controller) to the field device (device):

Menu Selection ▶ Diagnostics ▶ PROFINET Monitor

Analog Input	
AI 1	1.123e+02 %Air 0x80 GOOD (G)
AI 2	5.307e+00 mg/l 0x80 GOOD (G)
AI 3	6.000e+01 °C 0x80 GOOD (G)
AI 4	1.013e+03 mbar 0x80 GOOD (G)
AI 5	-6.994e+01 nA 0x80 GOOD (G)
AI 6	nan 0x27 BAD (F)

“nan” = not a number (no measured value available)

Measured Value Status

Description	Hex value / display	NE107 signal
BAD maintenance alarm ¹⁾	0x24 ... 0x27	 Failure
BAD process related	BAD (F)	 Failure
UNCERTAIN invalid process condition	0x28 ... 0x2B	 Out of specification
UNCERTAIN maintenance demanded	BAD (F)	 Maintenance required
GOOD maintenance demanded	0x78 ... 0x7B	 Maintenance required
BAD function check ²⁾	0x68 ... 0x7B	 Function check
GOOD function check ²⁾	0xA8 ... 0xAB	 Function check
GOOD ok ³⁾	0x3C	Good

¹⁾ If AI configuration = off: Status 0x27

²⁾ If function check is active

³⁾ If value is good or message is disabled

6.14.10 PROFINET Diagnostic Information

Diagnostic events are reported to the PROFINET controller and displayed, for example, in the TIA Portal. Every event generates an entry in the diagnostics buffer.

Details of the event can be displayed by double-clicking on the red icon by the controller icon.

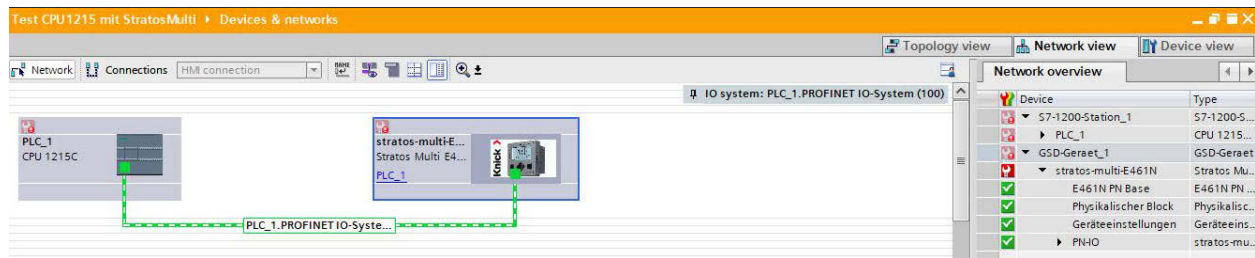

Diagnostics Buffer Menu (TIA Portal)

Transmission of diagnostic information can be enabled or disabled in the device menu:

Parameter Setting ▶ PROFINET ▶ Alarms/Diagnostics

Source	Error Type	Extended Error Type	State	Maintenance	Error Text
DIGI	300		Error	D	Firmware Error
DIGI	301		Error	D	System Failure
DIGI	302		Error	D	FRONT Indicates an Error
DIGI	303		Error	D	Internal Bus Error
DIGI	304		Error	D	Adjustment Data
DIGI	305		Error	D	Configuration Data Loss
DIGI	307		Error	D	Value out of Specification
DIGI	309		Alarm	MD	Value out of Range
DIGI	311		Alarm	MD	Inconsistent Parameter Setting
DIGI	312		Warning	MR	Value out of Range
DIGI	313		Warning	MR	Device is in Maintenance
DIGI	314		Warning	MR	Measurement Recorder Full
DIGI	315		Warning	MR	Memory Card Full
DIGI	316		Warning	MR	Memory Card
DIGI	317		Warning	MR	Audit Trail Card
DIGI	318	1	Info	QD	In Function Check
CHANNEL / SENSOR	400		Error	D	Firmware Error
CHANNEL / SENSOR	401		Error	D	Configuration Data Loss
CHANNEL / SENSOR	403		Error	D	No sensor connected
CHANNEL / SENSOR	404		Error	D	Wrong Sensor Connected
CHANNEL / SENSOR	405		Error	D	Sensor Devaluated
CHANNEL / SENSOR	406		Error	D	Sensor Defective
CHANNEL / SENSOR	407		Error	D	Adjustment Data
CHANNEL / SENSOR	408		Error	D	Sensor Memory (Cal Data)
CHANNEL / SENSOR	409		Error	D	Value out of Specification
CHANNEL / SENSOR	410		Alarm	MD	Value out of Range
CHANNEL / SENSOR	411		Alarm	MD	Man. Value out of Specification
CHANNEL / SENSOR	412		Alarm	MD	New Sensor – Adjustment Required
CHANNEL / SENSOR	414		Alarm	MD	TTM maintenance timer
CHANNEL / SENSOR	415		Alarm	MD	O2 Measurement OFF (Temp)

Source	Error Type	Extended Error Type	State	Maintenance	Error Text
CHANNEL / SENSOR	416		Warning	MR	Value out of Range
CHANNEL / SENSOR	417		Warning	MR	Calibration Mode Active
CHANNEL / SENSOR	418		Warning	MR	CIP counter
CHANNEL / SENSOR	419		Warning	MR	SIP counter
CHANNEL / SENSOR	420		Warning	MR	Autoclaving counter
CHANNEL / SENSOR	421	1	Info	QD	Function Check Active in Calibration Mode
CHANNEL / SENSOR	422	1	Info	QD	Error in Buffer Table
BASE_PN	500		Error	D	Firmware Error
BASE_PN	501		Error	D	Configuration Data Loss
BASE_PN	19	1	Error	D	KBUS Communication
DIGI	300		Error	D	Firmware Error

DIGI = digital basic unit

BASE_PN = PROFINET basic unit

D = diagnostics

MD = maintenance demanded

MR = maintenance required

QD = qualified diagnosis

6.14.11 Communication Status

Display

Active PROFINET communication is indicated by the PROFINET icon in the device's status display.

LEDs

(at Ethernet socket)

LED	Name	Meaning		
Yellow	TX/RX	Receive/Transmit	Off	Device does not transmit/receive any Ethernet frames.
			On (flickers)	Device transmitting/receiving Ethernet frames.
Green	LINK	Connection	Off	Connection not active
			On	Connection active
			Flashing	Data transmission

6.14.12 I&M Functions

I&M functions provide device data in a manufacturer-independent format. Data transfer is acyclic. Stratos Multi E461N supports the following standardized I&M functions.

I&M_0: Index 0xAFF0, access: Read only

Element	Name	Description
1	VendorIDHigh	0
2	VendorIDLow	0x61 (97) = Knick
3	Order ID	094516
4	IM_Serial_Number	
5	IM_Hardware_Revision	
6	IM_Software_Revision	
7	IM_RevisionCounter	
8	IM_Profile_ID	
9	IM_Profile_Specific_Type	5 (generic device).
10	IM_Version	
11	IM_Supported	

I&M_1: Index 0xAFF1, access: Read/write

Element	Name	Data type	Description
1	IM_Tag_Function	VisibleString(32)	Device function Presetting = empty string
2	IM_Tag_Location	VisibleString(22)	Device location ¹⁾

I&M_2: Index 0xAFF2, access: Read/write

Element	Name	Data type	Description
1	IM_Date	VisibleString(16)	Device function Presetting = empty string

I&M_3: Index 0xAFF3, access: Read/write

Element	Name	Data type	Description
1	IM_Descriptor	VisibleString(54)	Description ²⁾

¹⁾ Presetting as in device menu:

Parameter Setting ▶ System Control ▶ Meas. Point Description ▶ Meas. Point

²⁾ Presetting as in device menu:

Parameter Setting ▶ System Control ▶ Meas. Point Description ▶ Annotation

6.15 Flow

Stratos Multi can calculate flow for limit messages or to monitor an ion exchanger. A pulse generator is connected to control input OK1 for this purpose.

Parameter Setting

Control input OK1 must first be assigned the "Flow" function.

01. System Control ▶ Function Control
02. Input OK1 : Select "Flow".
03. 2x *left softkey*: **Back**
04. Inputs/Outputs ▶ Control Inputs ▶ Flow
05. Enter the number of pulses per liter.
06. If required, enable monitoring of the minimum and maximum flow.

The flow measurement can process up to 100 pulses per second at the signal input of control input OK1.

Flow Monitoring with a Connected External Flow Transmitter

Factory setting to generate a failure message

Minimum flow	5 liters/h
Maximum flow	25 liters/h

The flow messages can activate a relay contact and/or trigger a 22-mA message via a current output (user-defined).

7 Calibration/Adjustment

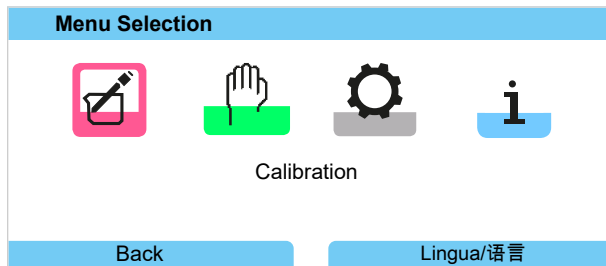

Note: During calibration, the function check (HOLD) operating state is active for each of the calibrated measuring channels. The outputs respond as configured.

During calibration, Stratos Multi remains in calibration mode until stopped by personnel. When calibration mode is exited, a confirmation prompt is displayed to ensure that the system is ready for operation again.

Adjustment

Adjustment involves the transfer of the calibration values obtained during calibration to Stratos Multi or the digital sensor. These calibration values are entered in the adjustment record of the Stratos Multi for the sensor, and directly in the sensor when using digital sensors:

Menu Selection ▶ Diagnostics ▶ I/II [Sensor] ▶ Cal/Adj Record [Process Variable]

NOTICE! Without adjustment, a measuring device will supply an imprecise or incorrect output value. For it to measure properly, Stratos Multi must be adjusted. When using analog sensors, adjustment is required following sensor replacement.

Adjustment may also be carried out later:

01. After completing calibration, press the **left softkey: Calibration**.
✓ The "Calibration Was Successful" information window appears.
02. **Right softkey: Close**
03. Either: Exit the Calibration menu by pressing the **left softkey: Back** and then return to the menu
04. Or: Remain in the Calibration menu and activate calibration again.
✓ A selection window appears.

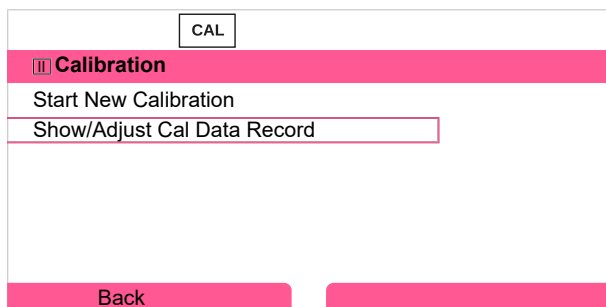

05. Select "Show/Adjust Cal Data Record".
✓ The calibration record is displayed.

06. Right softkey: Adjust

Assigning passcodes helps to ensure that only specialist personnel with access rights are allowed to carry out calibrations and adjustments.

The passcodes can be changed or disabled:

Parameter Setting ▶ System Control ▶ Passcode Entry → *Passcode Entry, p. 50*

First Adjustment

Note: Function active for ISM pH/ORP sensors and amperometric ISM oxygen sensors.

When you open the Calibration menu, you can choose to save the current calibration as the first adjustment.

The adjustment record values are then shown as a reference in the [Statistics](#) Diagnostics menu.

→ *Statistics, p. 157*

7.1 Memosens Calibration/Adjustment

Menu Selection ▶ Calibration ▶ [I] [II] Memosens ...

Note: The calibration data is saved in the Memosens sensor. This means that Memosens sensors can be cleaned, reconditioned, calibrated, and adjusted away from the measurement location, e.g., in a laboratory. Sensors in the system are replaced on-site by adjusted sensors.

7.2 pH Process Variable Calibration/Adjustment

Note: During calibration, the function check (HOLD) operating state is active for each of the calibrated measuring channels. The outputs respond as configured.

- Calibration: Detect deviations without readjustment of calibration data
- Adjustment: Detect deviations with readjustment of calibration data

NOTICE! When using analog sensors, adjustment is required following sensor replacement.

pH Calibration/Adjustment Explanations

Each pH sensor has a separate zero point and a separate slope. Both values change as a result of aging and wear. The voltage supplied by the pH sensor is corrected by Stratos Multi for the zero point and the electrode slope of the pH sensor, and displayed as the pH value.

During calibration, the sensor's deviation is initially determined (zero point, slope). The sensor is immersed in buffer solutions with a precisely known pH value for this purpose. Stratos Multi measures the voltages of the sensors and the temperature of the buffer solution, using this information to calculate the sensor's zero point and slope.

Calibration Values Determined During Calibration

Zero Point	The pH value at which the pH sensor supplies the voltage 0 mV. The zero point is different for each sensor and changes with age and wear.
Slope	The slope of a sensor is the voltage change per pH unit. With an ideal sensor, it is -59.2 mV/pH.
Temperature	The temperature of the process solution must be logged, since the pH measurement is temperature-dependent. Many sensors feature an integrated temperature detector.

There are limits that are calculated during calibration when monitoring glass and reference impedances. The following limits apply to standard glass electrodes:

- Temperature range: 0 ... 80 °C/32 ... 176 °F
- Impedance range: 50 ... 250 MΩ (at 25 °C/77 °F)

7.2.1 Calibration Methods

One-point calibration

The sensor is calibrated with just one buffer solution. A one-point calibration is useful and permissible if the measured values are close to the sensor zero point, such that the change in sensor slope is of negligible significance. The sensor's zero point is subsequently adjusted, while the slope remains unchanged.

Two-point calibration

The sensor is calibrated with two buffer solutions. This makes it possible to calculate the sensor's zero point and slope. The sensor's zero point and slope are subsequently adjusted. A two-point calibration is required in the following cases, for example:

- The sensor has been replaced
- The pH measured value covers a large range
- The pH measured value is far from the sensor zero point
- The pH value needs to be determined with high precision
- The sensor is subject to heavy wear

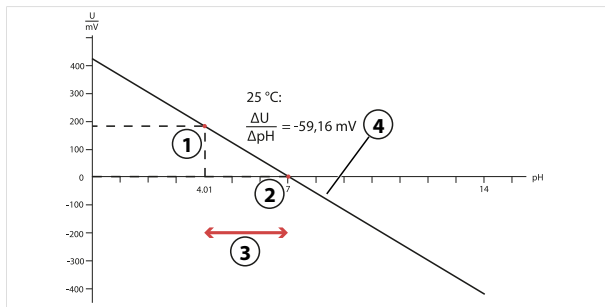

- | | |
|---|--|
| <p>1 First point of first buffer solution</p> <p>2 Second point of second buffer solution</p> | <p>3 Recommended measuring range</p> <p>4 Result of ideal calibration at 25 °C/77 °F</p> |
|---|--|

Three-point calibration

The sensor is calibrated with three buffer solutions.

The zero point and slope are calculated using a line of best fit in accordance with DIN 19268. The sensor's zero point and slope are subsequently adjusted.

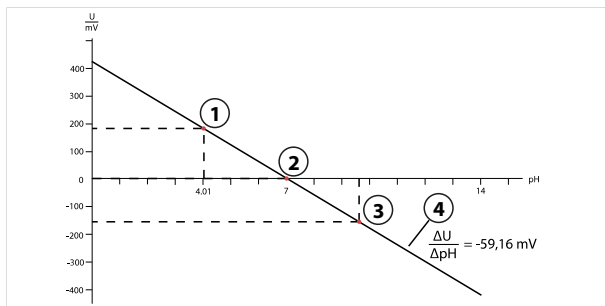

- | | |
|---|---|
| <p>1 First point of first buffer solution</p> <p>2 Second point of second buffer solution</p> | <p>3 Third point of third buffer solution</p> <p>4 Rise</p> |
|---|---|

7.2.2 Temperature Compensation during Calibration

Temperature Compensation during Calibration

The pH sensor's slope is temperature-dependent. The measured voltage must therefore be corrected by the temperature influence.

The buffer solution's pH value is temperature-dependent. During calibration, the temperature of the buffer solution must therefore be known so that the actual pH value can be obtained from the buffer table.

Automatic Temperature Compensation

Stratos Multi measures the temperature of the buffer solution using the temperature detector integrated in the pH sensor.

If the sensor does not have an integrated temperature detector:

- Connect an external temperature probe and select it in the Parameter Setting menu.
→ *Channel II Wiring Examples, p. 202*
- Set the manual temperature for calibration.

Settings can be changed in the **Temperature Detection** submenu:

Menu Selection ▶ Parameter Setting ▶ [II] Analog ... ▶ Sensor Data ▶ Temperature Detection
→ *Sensor Data, p. 70*

7.2.3 Calibration/Adjustment Methods

- Calimatic: Automatic buffer recognition
- Manual: Manual entry of buffer values
- Product: Calibration by sampling
- Data entry: Data entry of premeasured sensors
- Temperature: Temperature probe adjustment

7.2.4 Calibration Mode: Calimatic

Calibration with Automatic Buffer Recognition

During automatic calibration with Knick Calimatic, the sensor is immersed in one, two, or three buffer solutions. On the basis of the sensor voltage and the measured temperature, Stratos Multi automatically detects the nominal buffer value. The buffer solutions can be used in any order, but they must be part of the buffer set defined during parameter setting. Calimatic accounts for the temperature dependence of the buffer value. All calibration data is converted to a reference temperature of 25 °C/77 °F.

Calibration Procedure

NOTICE! Incorrect calibration results in incorrect output values. Use only new, undiluted buffer solutions that are part of the configured buffer set.

Calibration ▶ [I] [II] ... pH

When you access calibration, the calibration values selected in the calibration presettings are used. These settings can still be changed in the Calibration menu. If you do not want to perform calibration, use the left **softkey** to go back one level and abort the calibration.

01. Select "Calimatic" **Calibration Mode** and press **enter** to confirm.

- ✓ Number of calibrations points and buffer set configured as in **Cal Presettings**.
→ *Calibration Presettings, p. 73*

02. If required, change the number of calibration points and the buffer set.

03. Take the sensor out of the medium and rinse it in deionized water.

⚠ CAUTION! Risk of electrostatic discharge. Do not wipe the sensor or dab it dry.

04. Immerse the sensor in the first buffer solution.

05. Start calibration with the **right softkey: Next**.

✓ Calibration with first buffer is carried out.

The following parameters are displayed: Sensor Voltage, Calibration Temperature, Nominal Buffer Value, and Response Time.

The time for the measuring voltage to stabilize can be shortened with the **left softkey: Exit** (without drift check: reduced accuracy of calibration values). The response time indicates how long the sensor needs until the measuring voltage is stable. If the sensor voltage or the measured temperature fluctuate considerably, the calibration procedure is aborted after around 2 minutes. In this case, calibration needs to be restarted. Return the sensor to the process once this has been successfully completed. Make sure that the temperature of the sensor and the temperature of the buffer solution are not too far apart. The ideal temperature is 25 °C/77 °F.

06. For one-point calibration: Exit calibration by pressing the **softkey**.

07. For two-point calibration: Rinse the sensor well with deionized water.

08. Immerse the sensor in the second buffer solution.

09. Start calibration with the **right softkey: Next**.

✓ Calibration with second buffer is carried out.

10. Proceed as for one-point calibration.

11. For three-point calibration, the process uses the third buffer accordingly.

Result

- ✓ The calibration record is displayed. By pressing the **right softkey: Adjust**, the calibration values obtained during calibration for calculation of the process variables are applied to the device. When using a Memosens sensor, the calibration values are saved in the sensor.

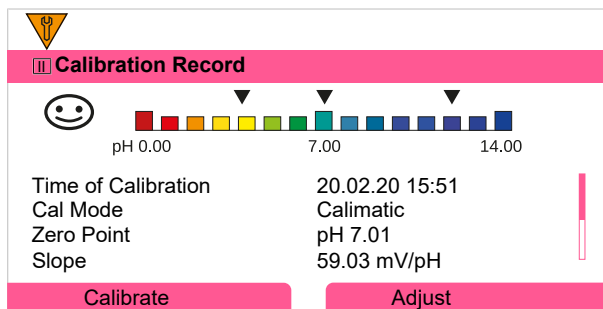

7.2.5 Calibration Mode: Manual

During calibration with manual entry of buffer values, the sensor is immersed in one, two, or three buffer solutions. Stratos Multi displays the measured temperature. The temperature-corrected buffer values must then be manually entered. For this purpose, take the buffer value that goes with the displayed temperature from the buffer table (e.g., on the bottle). Intermediate values must be interpolated. All calibration data is converted to a reference temperature of 25 °C/77 °F.

Calibration Procedure

NOTICE! Incorrect calibration results in incorrect output values. Use only new, undiluted buffer solutions that are part of the configured buffer set.

Calibration ▶ [I] [II] ... pH

When you access calibration, the calibration values selected in the calibration presets are used. These settings can still be changed in the Calibration menu. If you do not want to perform calibration, use the left **softkey** to go back one level and abort the calibration.

01. Select "Manual" **Calibration Mode** and press **enter** to confirm.
 - ✓ Number of calibration points configured as in **Cal Presettings**. → *Calibration Presettings, p. 73*
02. If required, change the number of calibration points.
03. Enter the first buffer value.
04. Continue with the **right softkey: Next**.
05. Take the sensor out of the medium and rinse it well in deionized water.

▲ CAUTION! Risk of electrostatic discharge. Do not wipe the sensor or dab it dry.

06. Immerse the sensor in the first buffer solution.
07. Start calibration with the **right softkey: Next**.
 - ✓ Calibration with first buffer is carried out.
 - The following parameters are displayed: Sensor Voltage, Calibration Temperature, Nominal Buffer Value, and Response Time.

The time for the measuring voltage to stabilize can be shortened with the **left softkey: Exit** (without drift check: reduced accuracy of calibration values). The response time indicates how long the sensor needs until the measuring voltage is stable. If the sensor voltage or the measured temperature fluctuate considerably, the calibration procedure is aborted after around 2 minutes. In this case, calibration needs to be restarted. Return the sensor to the process once this has been successfully completed. Make sure that the temperature of the sensor and the temperature of the buffer solution are not too far apart. The ideal temperature is 25 °C/77 °F.

08. For one-point calibration: Exit calibration by pressing the **softkey**.
09. For two-point calibration: Rinse the sensor well with deionized water.
10. Immerse the sensor in the second buffer solution.
11. Enter the second temperature-corrected buffer value.
12. Start calibration with the **right softkey: Next**.
 - ✓ Calibration with second buffer is carried out.
13. Proceed as for one-point calibration.
14. For three-point calibration, the process uses the third buffer accordingly.

Result

- ✓ The calibration record is displayed. By pressing the **right softkey: Adjust**, the calibration values obtained during calibration for calculation of the process variables are applied to the device. When using a Memosens sensor, the calibration values are saved in the sensor.

7.2.6 Calibration Mode: Product

Calibration by Sampling

If the sensor cannot be removed – e.g., for sterility reasons – its zero point can be calibrated by “sampling”. The currently measured value of the process is saved in the device for this purpose. A sample is taken directly afterward at the measuring point. The sample’s pH value is measured in the laboratory. The reference value is entered in the device. Stratos Multi calculates the sensor’s zero point from the difference between the measured and reference values. The slope is not changed in the process.

Note: Product calibration can also be carried out using PROFINET acyclic services.

→ *PROFINET Commands*, p. 111

Calibration Procedure

NOTICE! The sample’s pH value is temperature-dependent. The reference measurement should be carried out at the sample temperature shown on the display. The sample should be transported in a vacuum flask. The sample’s pH value may also be falsified if volatile substances escape.

Calibration ▶ [I] [II] ... pH

When you access calibration, the calibration values selected in the calibration presets are used. These settings can still be changed in the Calibration menu. If you do not want to perform calibration, use the left **softkey** to go back one level and abort the calibration.

01. Select “Product” Calibration Mode and press **enter** to confirm.

02. Prepare for sampling.

03. Start with the **right softkey: Next**.

Product calibration is performed in 2 steps.

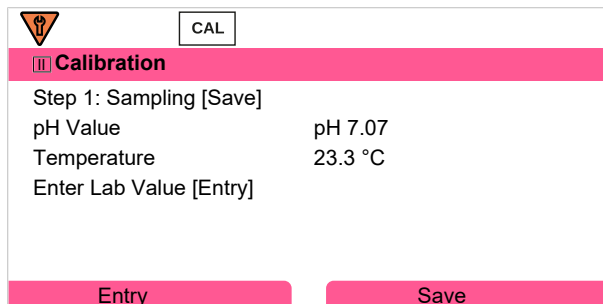

Step 1:

04. Take sample.

✓ The measured value and temperature at the time of sampling are displayed.

05. Save with the **right softkey: Save**.

✓ An information window is shown.

06. **Right softkey: Close**

07. As required, exit calibration by pressing the **left softkey: Back**.

Note: The icon  indicates that product calibration has not yet been completed.

Step 2: Lab value has been measured.

08. Open the Product Calibration menu again.

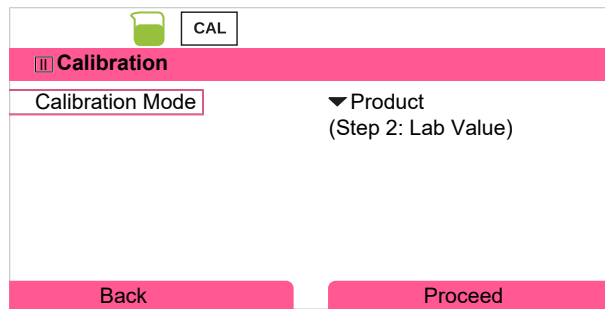

09. **Right softkey: Proceed**

10. Enter the lab value and press **enter** to confirm.

11. Confirm with the **right softkey: Next** or repeat calibration with the **left softkey: Cancel**.

Result

- ✓ The calibration record is displayed. By pressing the **right softkey: Adjust**, the calibration values obtained during calibration for calculation of the process variables are applied to the device. When using a Memosens sensor, the calibration values are saved in the sensor.

Exception: Sample value can be determined and entered on site:

12. Take sample.

- ✓ The measured value and temperature at the time of sampling are displayed.

13. **Left softkey: Entry**

14. Enter the lab value and press **enter** to confirm.

15. Confirm with the **right softkey: Next** or repeat calibration with the **left softkey: Cancel**.

Result

- ✓ The calibration record is displayed. By pressing the **right softkey: Adjust**, the calibration values obtained during calibration for calculation of the process variables are applied to the device. When using a Memosens sensor, the calibration values are saved in the sensor.

7.2.7 Calibration Mode: Data Entry

Calibration by entering the calibration values for the zero point and the slope of a premeasured sensor.

Calibration Procedure

Calibration ▶ [I] [II] ... pH

When you access calibration, the calibration values selected in the calibration presets are used. These settings can still be changed in the Calibration menu. If you do not want to perform calibration, use the left **softkey** to go back one level and abort the calibration.

01. Select "Data Entry" **Calibration Mode** and press **enter** to confirm.

02. Remove the sensor and install the premeasured sensor.

03. Continue with the **right softkey: Next**.

04. Enter the zero point and slope measured values.

05. With TAN option FW-E017 and when using a Pfaudler pH sensor, you can also enter the pH_{is} value for the isothermal intersection point. → *Pfaudler Sensors (FW-E017), p. 242*

Result

- ✓ The calibration record is displayed. By pressing the **right softkey: Adjust**, the calibration values obtained during calibration for calculation of the process variables are applied to the device. When using a Memosens sensor, the calibration values are saved in the sensor.

7.2.8 Calibration Mode: ISFET Zero Point

Setting the ISFET Operating Point

When using Memosens ISFET sensors for pH measurement, the individual operating point of the sensor first needs to be determined, and should be in the pH 6.5...pH 7.5 range. The sensor is immersed in a buffer solution with a pH value of 7.00 for this purpose.

Calibration Procedure

Calibration ▶ [I] [II] ... pH-ISFET

When you access calibration, the calibration values selected in the calibration presets are used. These settings can still be changed in the Calibration menu. If you do not want to perform calibration, use the left **softkey** to go back one level and abort the calibration.

01. Select the "ISFET Zero" Calibration Mode for setting the operating point for the first sensor calibration and press **enter** to confirm.
02. Press the **right softkey: Next**.
03. Adjust the buffer value if necessary: Default pH 7.00
04. Take the sensor out of the medium and rinse it well in deionized water.

▲ CAUTION! Risk of electrostatic discharge. Do not wipe the sensor or dab it dry.

05. Immerse the sensor in buffer solution.
06. Start calibration with the **right softkey: Next**.
 - ✓ The ISFET operating point is calculated.
07. Finally, confirm the ISFET operating point with the **right softkey: Adjust**.

A pH calibration, e.g., Calimatic 2-point calibration, can be performed afterward.

Note: The operating point only needs to be determined once for each ISFET sensor.

7.2.9 Calibration Mode: Temperature

Adjustment of the Temperature Probe

This function is used to adjust the individual temperature probe tolerances or cable lengths for the purpose of increasing the accuracy of the temperature measurement.

The adjustment requires an accurate measurement of the process temperature using a calibrated reference thermometer. The measurement error of the reference thermometer should be less than 0.1 K. Adjustment without an accurate measurement may result in falsification of the displayed measured value.

When using Memosens sensors, the adjustment value is saved in the sensor.

Calibration Procedure

Calibration ▶ [I] [II] [Sensor]

01. Select "Temperature" Calibration Mode and press **enter** to confirm.
02. Enter the measured process temperature and press **enter** to confirm.
 - ✓ The temperature offset is displayed.
03. Adjust the temperature probe with the **right softkey: Save**.

The current adjustment and temperature offset data can be displayed in the Diagnostics menu:

Diagnostics ▶ [I] [II] [Sensor] ▶ Temp. Offset Log

7.3 ORP Process Variable Calibration/Adjustment

Note: During calibration, the function check (HOLD) operating state is active for each of the calibrated measuring channels. The outputs respond as configured.

- Calibration: Detect deviations without readjustment of calibration data
- Adjustment: Detect deviations with readjustment of calibration data

NOTICE! When using analog sensors, adjustment is required following sensor replacement.

Calibration/Adjustment Methods

- ORP data entry
- ORP adjustment
- ORP check
- Temperature probe adjustment

7.3.1 Calibration Mode: ORP Data Entry

Calibration by entering the ORP offset of a premeasured sensor.

Calibration Procedure

Calibration ▶ [I] [III] [ORP Sensor]

When you access calibration, the calibration values selected in the calibration presets are used. These settings can still be changed in the Calibration menu. If you do not want to perform calibration, use the left **softkey** to go back one level and abort the calibration.

01. Select "ORP Data Entry" **Calibration Mode** and press **enter** to confirm.
02. Remove the sensor and install the premeasured sensor.
03. Continue with the **right softkey: Next**.
04. Enter the ORP offset value.

Result

- ✓ The calibration record is displayed. By pressing the **right softkey: Adjust**, the calibration values obtained during calibration for calculation of the process variables are applied to the device. When using a Memosens sensor, the calibration values are saved in the sensor.

7.3.2 Calibration Mode: ORP Adjustment

The sensor is immersed in an ORP buffer solution for ORP adjustment. Stratos Multi displays the measured temperature and the ORP. The temperature-corrected buffer values must then be manually entered. For this purpose, take the buffer value that goes with the displayed temperature from the buffer table (e.g., on the bottle). Intermediate values must be interpolated. All calibration data is converted to a reference temperature of 25 °C/77 °F.

Calibration Procedure

Calibration ▶ [I] [II] [ORP Sensor]

When you access calibration, the calibration values selected in the calibration presettings are used. These settings can still be changed in the Calibration menu. If you do not want to perform calibration, use the left **softkey** to go back one level and abort the calibration.

01. Select "ORP Adjustment" **Calibration Mode** and press **enter** to confirm.
02. Continue with the **right softkey: Next**.
03. Take the sensor out of the medium and rinse it well in deionized water.

▲ CAUTION! Risk of electrostatic discharge. Do not wipe the sensor or dab it dry.

04. Immerse the sensor in the ORP buffer solution and wait for the ORP measured value to stabilize.
05. Start calibration with the **right softkey: Next**.
 - ✓ When the drift check is complete, the measured temperature and ORP are displayed.

The time for the measuring voltage to stabilize can be shortened with the **left softkey: Exit** (without drift check: reduced accuracy of calibration values). The response time indicates how long the sensor needs until the measuring voltage is stable. If the sensor voltage or the measured temperature fluctuate considerably, the calibration procedure is aborted after around 2 minutes. In this case, calibration needs to be restarted. Return the sensor to the process once this has been successfully completed. Make sure that the temperature of the sensor and the temperature of the buffer solution are not too far apart. The ideal temperature is 25 °C/77 °F.

06. Enter the ORP setpoint (printed on bottle) of the buffer solution in the **Calibration Mode ▶ ORP Adjustment ▶ Redox Buffer** submenu and press **enter** to confirm.

Enter ORP Setpoint	
Temperature	23.3 °C
ORP	215 mV
Redox Buffer	218.3 mV

07. Exit calibration with the **right softkey: Next**.

Result

- ✓ The calibration record is displayed. By pressing the **right softkey: Adjust**, the calibration values obtained during calibration for calculation of the process variables are applied to the device. When using a Memosens sensor, the calibration values are saved in the sensor.

7.3.3 Calibration Mode: ORP Check

The sensor is immersed in a solution with a known ORP value for the ORP check. The test period and the permissible test difference are specified during parameter setting:

Parameter Setting ▶ [I] [II] [ORP Sensor] ▶ Cal Presettings

Calibration Procedure

Calibration ▶ [I] [II] [ORP Sensor]

When you access calibration, the calibration values selected in the calibration presettings are used. These settings can still be changed in the Calibration menu. If you do not want to perform calibration, use the left **softkey** to go back one level and abort the calibration.

01. Select "ORP Check" Calibration Mode and press **enter** to confirm.

02. Take the sensor out of the medium and rinse it well in deionized water.

▲ CAUTION! Risk of electrostatic discharge. Do not wipe the sensor or dab it dry.

03. Immerse the sensor in the ORP solution and wait for the ORP measured value to stabilize.

04. Start ORP check with the **right softkey: Next**.

- ✓ When the drift check is complete, the measured temperature and ORP are displayed.
- ✓ If the specified test difference was not exceeded, the message "ORP Check Successful" appears. If the specified test difference was exceeded, the message "ORP Check Unsuccessful" appears.

05. ORP adjustment should be carried out in the event of an unsuccessful ORP check.

7.3.4 Calibration Mode: Temperature

Adjustment of the Temperature Probe

This function is used to adjust the individual temperature probe tolerances or cable lengths for the purpose of increasing the accuracy of the temperature measurement.

The adjustment requires an accurate measurement of the process temperature using a calibrated reference thermometer. The measurement error of the reference thermometer should be less than 0.1 K. Adjustment without an accurate measurement may result in falsification of the displayed measured value.

When using Memosens sensors, the adjustment value is saved in the sensor.

Calibration Procedure

Calibration ▶ [I] [II] [Sensor]

01. Select "Temperature" Calibration Mode and press **enter** to confirm.

02. Enter the measured process temperature and press **enter** to confirm.

- ✓ The temperature offset is displayed.

03. Adjust the temperature probe with the **right softkey: Save**.

The current adjustment and temperature offset data can be displayed in the Diagnostics menu:

Diagnostics ▶ [I] [II] [Sensor] ▶ Temp. Offset Log

7.4 Conductivity (Contacting) Process Variable Calibration/Adjustment

Note: During calibration, the function check (HOLD) operating state is active for each of the calibrated measuring channels. The outputs respond as configured.

- Calibration: Detect deviations without readjustment of calibration data
- Adjustment: Detect deviations with readjustment of calibration data

NOTICE! When using analog sensors, adjustment is required following sensor replacement.

Explanations Regarding Calibration/Adjustment with 2-/4-Electrode Sensors

Each conductivity sensor has an individual cell constant. Depending on the sensor design, the cell constant may vary over a wide range. Because the conductivity value is calculated from the measured conductance and the cell constant, the device must know the cell constant. During calibration or sensor adjustment, either the known (printed) cell constant of the used conductivity sensor is entered in the device, or it is determined automatically by measuring a calibration solution with known conductivity.

Notes on Calibration

- Use only fresh calibration solutions.
- The used calibration solution must be configured.
- The accuracy of the calibration is crucially dependent on a precise acquisition of the calibration solution temperature. On the basis of the measured or entered temperature, Stratos Multi calculates the setpoint of the calibration solution from a stored table.
- Note the response time of the temperature probe.
- To determine the exact cell constant, wait for temperature equalization of the temperature probe and calibration solution before calibration.

Since the cell constant is subject to production-related fluctuations, it is recommended that the removed sensor be calibrated with a calibration solution (e.g., saturated NaCl). The cell constants of the sensors are dependent on the installation geometry – especially in the case of fringe-field sensors:

- If the sensor is installed in a free space (minimum distances exceeded), the cell constant specified in the specifications can be entered directly.
"Data Entry" Calibration Mode . → *Calibration Mode: Data Entry, p. 138*
- If the installation space is tight (minimum distances are not reached), the sensor must be adjusted in its installed state, as the resulting cell constant has changed.
"Product" Calibration Mode . → *Calibration Mode: Product, p. 136*

7.4.1 Temperature Compensation during Calibration

The conductivity value of the calibration solution is temperature-dependent. During calibration, the temperature of the calibration solution must therefore be known so that the actual value can be obtained from the conductivity table.

Automatic Temperature Compensation

During automatic logging of the calibration temperature, Stratos Multi measures the temperature of the calibration solution using the temperature detector integrated in the Memosens sensor.

If the sensor does not have an integrated temperature detector:

- Connect an external temperature probe and select it in the Parameter Setting menu.
→ *Channel II Wiring Examples, p. 202*
- Set the manual temperature for calibration.

Settings can be changed in the **Temperature Detection** submenu:

Menu Selection ▶ Parameter Setting ▶ [II] Analog ... ▶ Sensor Data ▶ Temperature Detection

7.4.2 Calibration/Adjustment Methods

- Automatic calibration: Automatic with standard calibration solution
- Manual: Manual entry of a calibration solution
- Product: Product calibration (calibration with sampling)
- Data entry: Data entry of premeasured sensors
- Temperature: Temperature probe adjustment

7.4.3 Calibration Mode: Automatic

Automatic Calibration with Standard Calibration Solution

During automatic calibration, the conductivity sensor is immersed in a standard calibration solution (NaCl or KCl, set during parameter setting in the **Cal Presettings** submenu). On the basis of the measured conductance and temperature, Stratos Multi automatically calculates the cell constant. The temperature dependence of the calibration solution is accounted for.

Notes on Calibration

- Use only fresh calibration solutions. The used calibration solution must be configured.
- The accuracy of the calibration is crucially dependent on a precise acquisition of the calibration solution temperature. On the basis of the measured or entered temperature, Stratos Multi calculates the setpoint of the calibration solution from a stored table.
- Note the response time of the temperature probe.
- To determine the exact cell constant, wait for temperature equalization of the temperature probe and calibration solution before calibration.
- If the measured conductance or temperature fluctuate greatly, the calibration procedure is aborted after approx. 2 min. Repeat calibration if an error message appears.

Calibration Procedure

Calibration ▶ [I] [II] ... Cond

When you access calibration, the calibration values selected in the calibration presettings are used. These settings can still be changed in the Calibration menu. If you do not want to perform calibration, use the left **softkey** to go back one level and abort the calibration.

01. Select "Automatic" **Calibration Mode** and press **enter** to confirm.
 - ✓ Display of calibration solution as configured in **Cal Presettings**.
02. Change the calibration solution, if required.
03. Take the sensor out of the medium and rinse it well in deionized water.
04. Immerse the sensor in the calibration solution.
05. Start calibration with the **right softkey: Next**.
 - ✓ Calibration is performed.
The following parameters are displayed: Calibration temperature, solution table value (conductivity depending on calibration temperature), and response time.

Result

- ✓ The calibration record is displayed. By pressing the **right softkey: Adjust**, the calibration values obtained during calibration for calculation of the process variables are applied to the device. When using a Memosens sensor, the calibration values are saved in the sensor.

7.4.4 Calibration Mode: Manual

Manual Calibration Specifying a Calibration Solution

During calibration with manual entry of the conductivity value of the calibration solution, the sensor is immersed in a calibration solution. Stratos Multi calculates a conductivity/calibration temperature pair value. The temperature-corrected conductivity value of the calibration solution must then be entered. For this purpose, take the conductivity value that goes with the displayed temperature from the calibration solution TC table. Conductivity intermediate values must be interpolated.

Stratos Multi automatically calculates the cell constant.

Notes on Calibration

- Use only fresh calibration solutions. The used calibration solution must be configured.
- The accuracy of the calibration is crucially dependent on a precise acquisition of the calibration solution temperature. On the basis of the measured or entered temperature, Stratos Multi calculates the setpoint of the calibration solution from a stored table.
- Note the response time of the temperature probe.
- To determine the exact cell constant, wait for temperature equalization of the temperature probe and calibration solution before calibration.
- If the measured conductance or temperature fluctuate greatly, the calibration procedure is aborted after approx. 2 min. Repeat calibration if an error message appears.

Calibration Procedure

Calibration ▶ [I] [II] ... Cond

When you access calibration, the calibration values selected in the calibration presets are used. These settings can still be changed in the Calibration menu. If you do not want to perform calibration, use the left **softkey** to go back one level and abort the calibration.

01. Select "Manual" **Calibration Mode** and press **enter** to confirm.
02. Take the sensor out of the medium, rinse it well in deionized water, and dry it.
03. Immerse the sensor in the calibration solution.
04. Start calibration with the **right softkey: Next**.
 - ✓ Calibration is performed.
 - The following parameters are displayed: Calibration temperature and response time.
05. Enter conductivity.
06. Continue with the **right softkey: Next**.

Result

- ✓ The calibration record is displayed. By pressing the **right softkey: Adjust**, the calibration values obtained during calibration for calculation of the process variables are applied to the device. When using a Memosens sensor, the calibration values are saved in the sensor.

7.4.5 Calibration Mode: Product

Calibration by Sampling

If the sensor cannot be removed – e.g., for sterility reasons – its cell constant can be determined by “sampling”. The currently measured value (conductivity or concentration ¹⁾) of the process from Stratos Multi is stored for this purpose. Right after this, take a sample from the process. The value of this sample is measured under process conditions (same temperature!) wherever possible. The calculated value is entered in the measuring system. Stratos Multi calculates the conductivity sensor’s cell constant from the deviation between the process measured value and the sample value.

Note: Product calibration can also be carried out using PROFINET acyclic services.
→ *PROFINET Commands*, p. 111

Product Calibration without TC Compensation (With Conductivity)

A sample is taken from the process. The sample’s measured value is determined in the laboratory at the temperature at which the sample was taken (“Sample Temperature”, see display). It may be necessary to thermostat the sample in the laboratory accordingly. Temperature compensation of the reference measuring devices must be disabled (TC = 0 %/K).

Product Calibration with TC Compensation $T_{ref} = 25\text{ °C}/77\text{ °F}$ (With Conductivity)

A sample is taken from the process. During measurement in the laboratory (TC linear), the same values for reference temperature and temperature coefficient must be set in both the reference measuring device and Stratos Multi. In addition, the measuring temperature should match the sample temperature (see display) as closely as possible. The sample should be transported in a vacuum flask (Dewar) to ensure this.

NOTICE! Product calibration is only possible if the process medium is stable (no chemical reactions that affect conductivity). At higher temperatures, evaporation may falsify results.

Calibration Procedure

Calibration ▶ [I] [II] ... Cond

When you access calibration, the calibration values selected in the calibration presets are used. These settings can still be changed in the Calibration menu. If you do not want to perform calibration, use the left **softkey** to go back one level and abort the calibration.

01. Select “Product” Calibration Mode and press **enter** to confirm.
02. Prepare for sampling.
03. Start with the **right softkey: Next**.

Product calibration is performed in 2 steps.

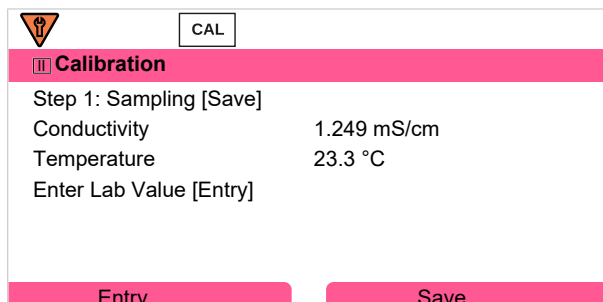

CAL	
Calibration	
Step 1: Sampling [Save]	
Conductivity	1.249 mS/cm
Temperature	23.3 °C
Enter Lab Value [Entry]	
Entry	Save

Step 1:

04. Take sample.
 - ✓ The measured value and temperature at the time of sampling are displayed.

¹⁾ First enable TAN option FW-E009. → *Concentration Determination (FW-E009)*, p. 237

05. Save with the **right softkey: Save**.
 ✓ An information window is shown.

06. **Right softkey: Close**

07. As required, exit calibration by pressing the **left softkey: Back**.

Note: The icon  indicates that product calibration has not yet been completed.

Step 2: Lab value has been measured.

08. Open the Product Calibration menu again.

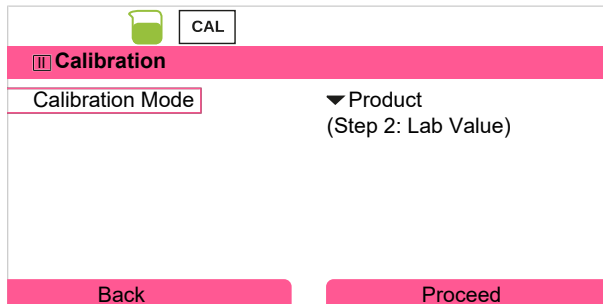

09. **Right softkey: Proceed**

10. Enter the lab value and press **enter** to confirm.

11. Confirm with the **right softkey: Next** or repeat calibration with the **left softkey: Cancel**.

Result

- ✓ The calibration record is displayed. By pressing the **right softkey: Adjust**, the calibration values obtained during calibration for calculation of the process variables are applied to the device. When using a Memosens sensor, the calibration values are saved in the sensor.

Exception: Sample value can be determined and entered on site:

12. Take sample.

- ✓ The measured value and temperature at the time of sampling are displayed.

13. **Left softkey: Entry**

14. Enter the lab value and press **enter** to confirm.

15. Confirm with the **right softkey: Next** or repeat calibration with the **left softkey: Cancel**.

Result

- ✓ The calibration record is displayed. By pressing the **right softkey: Adjust**, the calibration values obtained during calibration for calculation of the process variables are applied to the device. When using a Memosens sensor, the calibration values are saved in the sensor.

7.4.6 Calibration Mode: Data Entry

Entry of values for the cell constant of a sensor, related to 25 °C/77 °F.

Calibration Procedure

Calibration ▶ [I] [II] ... Cond

When you access calibration, the calibration values selected in the calibration presets are used. These settings can still be changed in the Calibration menu. If you do not want to perform calibration, use the left **softkey** to go back one level and abort the calibration.

01. Select "Data Entry" Calibration Mode and press **enter** to confirm.
02. Remove the sensor and install the premeasured sensor.
03. Continue with the **right softkey: Next**.
04. Enter the cell constant of the premeasured sensor.

Result

- ✓ The calibration record is displayed. By pressing the **right softkey: Adjust**, the calibration values obtained during calibration for calculation of the process variables are applied to the device. When using a Memosens sensor, the calibration values are saved in the sensor.

7.4.7 Calibration Mode: Temperature

Adjustment of the Temperature Probe

This function is used to adjust the individual temperature probe tolerances or cable lengths for the purpose of increasing the accuracy of the temperature measurement.

The adjustment requires an accurate measurement of the process temperature using a calibrated reference thermometer. The measurement error of the reference thermometer should be less than 0.1 K. Adjustment without an accurate measurement may result in falsification of the displayed measured value.

When using Memosens sensors, the adjustment value is saved in the sensor.

Calibration Procedure

Calibration ▶ [I] [II] [Sensor]

01. Select "Temperature" Calibration Mode and press **enter** to confirm.
02. Enter the measured process temperature and press **enter** to confirm.
 - ✓ The temperature offset is displayed.
03. Adjust the temperature probe with the **right softkey: Save**.

The current adjustment and temperature offset data can be displayed in the Diagnostics menu:

Diagnostics ▶ [I] [II] [Sensor] ▶ Temp. Offset Log

7.5 Conductivity (Inductive) Process Variable Calibration/Adjustment

Note: During calibration, the function check (HOLD) operating state is active for each of the calibrated measuring channels. The outputs respond as configured.

- Calibration: Detect deviations without readjustment of calibration data
- Adjustment: Detect deviations with readjustment of calibration data

NOTICE! When using analog sensors, adjustment is required following sensor replacement.

Explanations Regarding Calibration/Adjustment with Toroidal Sensors

Each inductive (toroidal) conductivity sensor has an individual cell factor. The cell factor may vary depending on the sensor design. Because the conductivity value is calculated from the measured conductance and the cell factor, the measuring system must know the cell factor. During calibration or sensor adjustment, either the known (printed) cell factor of the used toroidal conductivity sensor is entered in the measuring system, or it is determined automatically by measuring a calibration solution with known conductivity.

Notes on Calibration

- Use only fresh calibration solutions.
- The used calibration solution must be configured.
- The accuracy of the calibration is crucially dependent on a precise acquisition of the calibration solution temperature. On the basis of the measured or entered temperature, Stratos Multi calculates the setpoint of the calibration solution from a stored table.
- Note the response time of the temperature probe.
- To determine the exact cell factor, wait for temperature equalization of the temperature probe and calibration solution before calibration.

Since the cell factor is subject to production-related fluctuations, it is recommended that the removed sensor be calibrated with a calibration solution (e.g., saturated NaCl).

- If the installation space is tight (minimum distances are not reached), the sensor must be adjusted in its installed state, as the resulting cell factor has changed.

Calibration mode: "Product Calibration".

7.5.1 Temperature Compensation during Calibration

The conductivity value of the calibration solution is temperature-dependent. During calibration, the temperature of the calibration solution must therefore be known so that the actual value can be obtained from the conductivity table.

Automatic Temperature Compensation

During automatic logging of the calibration temperature, Stratos Multi measures the temperature of the calibration solution using the temperature detector integrated in the Memosens sensor.

If the sensor does not have an integrated temperature detector:

- Connect an external temperature probe and select it in the Parameter Setting menu.
→ *Channel II Wiring Examples, p. 202*
- Set the manual temperature for calibration.

Settings can be changed in the **Temperature Detection** submenu:

Menu Selection ▶ Parameter Setting ▶ [II] Analog ... ▶ Sensor Data ▶ Temperature Detection

7.5.2 Calibration/Adjustment Methods

- Automatic: Automatic with standard calibration solution
- Manual: Manual entry of a calibration solution
- Product: Product calibration (calibration with sampling)
- Zero point: Zero point correction
- Installation factor: Entry of an installation factor (with Memosens sensors)
- Data entry: Data entry of premeasured sensors
- Temperature: Temperature probe adjustment

7.5.3 Calibration Mode: Automatic

Automatic Calibration with Standard Calibration Solution

During automatic calibration, the conductivity sensor is immersed in a standard calibration solution (NaCl or KCl, set during parameter setting). On the basis of the measured conductance and temperature, Stratos Multi automatically calculates the cell factor. The temperature dependence of the calibration solution is accounted for.

Notes on Calibration

- Use only fresh calibration solutions. The used calibration solution must be configured.
- The accuracy of the calibration is crucially dependent on a precise acquisition of the calibration solution temperature. On the basis of the measured or entered temperature, Stratos Multi calculates the setpoint of the calibration solution from a stored table.
- Note the response time of the temperature probe.
- To determine the exact cell factor, wait for temperature equalization of the temperature probe and calibration solution before calibration.
- If the measured conductance or temperature fluctuate greatly, the calibration procedure is aborted after approx. 2 min. Repeat calibration if an error message appears.

Calibration Procedure

Calibration ▶ [I] [II] ... Condl

When you access calibration, the calibration values selected in the calibration presets are used. These settings can still be changed in the Calibration menu. If you do not want to perform calibration, use the left **softkey** to go back one level and abort the calibration.

01. Select "Automatic" **Calibration Mode** and press **enter** to confirm.
 - ✓ Display of calibration solution as configured in **Cal Presettings**.
02. Change the calibration solution, if required.
03. Take the sensor out of the medium, rinse it well in deionized water, and dry it.
04. Immerse the sensor in the calibration solution.
05. Start calibration with the **right softkey: Next**.
 - ✓ Calibration is performed.
The following parameters are displayed: Calibration temperature, solution table value (conductivity depending on calibration temperature), and response time.

Result

- ✓ The calibration record is displayed. By pressing the **right softkey: Adjust**, the calibration values obtained during calibration for calculation of the process variables are applied to the device. When using a Memosens sensor, the calibration values are saved in the sensor.

7.5.4 Calibration Mode: Manual

Manual Calibration Specifying a Calibration Solution

During calibration with manual entry of the conductivity value of the calibration solution, the sensor is immersed in a calibration solution. Stratos Multi calculates a conductivity/calibration temperature pair value. The temperature-corrected conductivity value of the calibration solution must then be entered. For this purpose, take the conductivity value that goes with the displayed temperature from the calibration solution TC table. Conductivity intermediate values must be interpolated.

Stratos Multi automatically calculates the cell factor.

Notes on Calibration

- Use only fresh calibration solutions. The used calibration solution must be configured.
- The accuracy of the calibration is crucially dependent on a precise acquisition of the calibration solution temperature. On the basis of the measured or entered temperature, Stratos Multi calculates the setpoint of the calibration solution from a stored table.
- Note the response time of the temperature probe.
- To determine the exact cell factor, wait for temperature equalization of the temperature probe and calibration solution before calibration.
- If the measured conductance or temperature fluctuate greatly, the calibration procedure is aborted after approx. 2 min. Repeat calibration if an error message appears.

Calibration Procedure

Calibration ▶ [I] [II] ... Condl

When you access calibration, the calibration values selected in the calibration presets are used. These settings can still be changed in the Calibration menu. If you do not want to perform calibration, use the left **softkey** to go back one level and abort the calibration.

01. Select "Manual" **Calibration Mode** and press **enter** to confirm.
02. Take the sensor out of the medium and rinse it well in deionized water.
03. Immerse the sensor in the calibration solution.
04. Start calibration with the **right softkey: Next**.
 - ✓ Calibration is performed.
 - The following parameters are displayed: Calibration temperature and response time.
05. Enter conductivity.
06. Continue with the **right softkey: Next**.

Result

- ✓ The calibration record is displayed. By pressing the **right softkey: Adjust**, the calibration values obtained during calibration for calculation of the process variables are applied to the device. When using a Memosens sensor, the calibration values are saved in the sensor.

7.5.5 Calibration Mode: Product

Calibration by Sampling

If the sensor cannot be removed – e.g., for sterility reasons – its cell factor can be determined by “sampling”. The currently measured value (conductivity or concentration ¹⁾) of the process from Stratos Multi is stored for this purpose. Right after this, take a sample from the process. The value of this sample is measured under process conditions (same temperature!) wherever possible. The calculated value is entered in the measuring system. Stratos Multi calculates the conductivity sensor’s cell factor from the deviation between the process measured value and the sample value.

Note: Product calibration can also be carried out using PROFINET acyclic services.

→ *PROFINET Commands*, p. 111

Product Calibration without TC Compensation (With Conductivity)

A sample is taken from the process. The sample’s measured value is determined in the laboratory at the temperature at which the sample was taken (“Sample Temperature”, see display). It may be necessary to thermostat the sample in the laboratory accordingly. Temperature compensation of the reference measuring devices must be disabled (TC = 0 %/K).

Product Calibration with TC Compensation $T_{ref} = 25\text{ °C}/77\text{ °F}$ (With Conductivity)

A sample is taken from the process. During measurement in the laboratory (TC linear), the same values for reference temperature and temperature coefficient must be set in both the reference measuring device and Stratos Multi. In addition, the measuring temperature should match the sample temperature (see display) as closely as possible. The sample should be transported in a vacuum flask (Dewar) to ensure this.

NOTICE! Product calibration is only possible if the process medium is stable (no chemical reactions that affect conductivity). At higher temperatures, evaporation may falsify results.

Calibration Procedure

Calibration ▶ [I] [II] ... Condl

When you access calibration, the calibration values selected in the calibration presets are used. These settings can still be changed in the Calibration menu. If you do not want to perform calibration, use the left **softkey** to go back one level and abort the calibration.

01. Select “Product” Calibration Mode and press **enter** to confirm.
02. Prepare for sampling.
03. Start with the **right softkey: Next**.

Product calibration is performed in 2 steps.

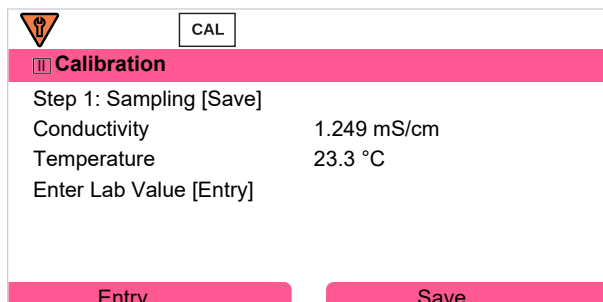

CAL	
Calibration	
Step 1: Sampling [Save]	
Conductivity	1.249 mS/cm
Temperature	23.3 °C
Enter Lab Value [Entry]	
Entry	Save

Step 1:

04. Take sample.
 - ✓ The measured value and temperature at the time of sampling are displayed.

¹⁾ First enable TAN option FW-E009. → *Concentration Determination (FW-E009)*, p. 237

05. Save with the **right softkey: Save**.
 ✓ An information window is shown.

06. **Right softkey: Close**

07. As required, exit calibration by pressing the **left softkey: Back**.

Note: The icon  indicates that product calibration has not yet been completed.

Step 2: Lab value has been measured.

08. Open the Product Calibration menu again.

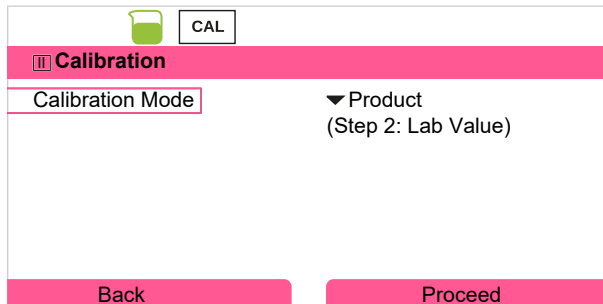

09. **Right softkey: Proceed**

10. Enter the lab value and press **enter** to confirm.

11. Confirm with the **right softkey: Next** or repeat calibration with the **left softkey: Cancel**.

Result

- ✓ The calibration record is displayed. By pressing the **right softkey: Adjust**, the calibration values obtained during calibration for calculation of the process variables are applied to the device. When using a Memosens sensor, the calibration values are saved in the sensor.

Exception: Sample value can be determined and entered on site:

12. Take sample.

- ✓ The measured value and temperature at the time of sampling are displayed.

13. **Left softkey: Entry**

14. Enter the lab value and press **enter** to confirm.

15. Confirm with the **right softkey: Next** or repeat calibration with the **left softkey: Cancel**.

Result

- ✓ The calibration record is displayed. By pressing the **right softkey: Adjust**, the calibration values obtained during calibration for calculation of the process variables are applied to the device. When using a Memosens sensor, the calibration values are saved in the sensor.

7.5.6 Calibration Mode: Zero Point

Calibration Procedure

Calibration ▶ [I] [II] ... Condl

When you access calibration, the calibration values selected in the calibration presets are used. These settings can still be changed in the Calibration menu. If you do not want to perform calibration, use the left **softkey** to go back one level and abort the calibration.

01. Select "Zero Point" Calibration Mode and press **enter** to confirm.
02. Take the sensor out of the medium, rinse it in deionized water, and dry it. The sensor should be dry, since zero calibration is performed in air.
03. Press the **right softkey: Next**.
 - ✓ Zero correction is carried out. The permissible zero offset is dependent on the sensor type.
04. Press the **right softkey: Next**.

Result

- ✓ The calibration record is displayed. By pressing the **right softkey: Adjust**, the calibration values obtained during calibration for calculation of the process variables are applied to the device. When using a Memosens sensor, the calibration values are saved in the sensor.

Valid for toroidal conductivity with Memosens sensors:

The calibration values are displayed following successful zero calibration.

05. Press the **right softkey: Next**.
 - ✓ The message "Adjustment Successful" is shown.

7.5.7 Calibration Mode: Installation Factor

When using a Memosens sensor in a tight space, the installation factor is entered.

Calibration Procedure

Calibration ▶ [I] [II] ... Condl

When you access calibration, the calibration values selected in the calibration presets are used. These settings can still be changed in the Calibration menu. If you do not want to perform calibration, use the left **softkey** to go back one level and abort the calibration.

01. Select "Install. Factor" Calibration Mode and press **enter** to confirm.
02. Enter the installation factor.
03. Continue with the **right softkey: Save**.
 - ✓ The message "Adjustment Successful" is shown.

7.5.8 Calibration Mode: Data Entry

Entry of values for the cell factor and zero point of a sensor, related to 25 °C/77 °F.

If concentration measurement is activated (TAN option FW-E009), the concentration is also shown in this menu and directly adjusted with the cell factor. This makes direct calibration to the concentration value possible.

Calibration Procedure

Calibration ▶ [I] [II] ... Condi

When you access calibration, the calibration values selected in the calibration presets are used. These settings can still be changed in the Calibration menu. If you do not want to perform calibration, use the left **softkey** to go back one level and abort the calibration.

01. Select "Data Entry" Calibration Mode and press **enter** to confirm.
02. Remove the sensor and install the premeasured sensor.
03. Continue with the **right softkey: Next**.
04. Enter the cell factor of the premeasured sensor.

Result

- ✓ The calibration record is displayed. By pressing the **right softkey: Adjust**, the calibration values obtained during calibration for calculation of the process variables are applied to the device. When using a Memosens sensor, the calibration values are saved in the sensor.

7.5.9 Calibration Mode: Temperature

Adjustment of the Temperature Probe

This function is used to adjust the individual temperature probe tolerances or cable lengths for the purpose of increasing the accuracy of the temperature measurement.

The adjustment requires an accurate measurement of the process temperature using a calibrated reference thermometer. The measurement error of the reference thermometer should be less than 0.1 K. Adjustment without an accurate measurement may result in falsification of the displayed measured value.

When using Memosens sensors, the adjustment value is saved in the sensor.

Calibration Procedure

Calibration ▶ [I] [II] [Sensor]

01. Select "Temperature" Calibration Mode and press **enter** to confirm.
02. Enter the measured process temperature and press **enter** to confirm.
 - ✓ The temperature offset is displayed.
03. Adjust the temperature probe with the **right softkey: Save**.

The current adjustment and temperature offset data can be displayed in the Diagnostics menu:

Diagnostics ▶ [I] [II] [Sensor] ▶ Temp. Offset Log

7.6 Oxygen Process Variable Calibration/Adjustment

Note: During calibration, the function check (HOLD) operating state is active for each of the calibrated measuring channels. The outputs respond as configured.

- Calibration: Detect deviations without readjustment of calibration data
- Adjustment: Detect deviations with readjustment of calibration data

NOTICE! When using analog sensors, adjustment is required following sensor replacement.

Oxygen Calibration/Adjustment Explanations

Every oxygen sensor has an individual slope and an individual zero point. Both values change, for example, as a result of aging and wear. For a sufficiently accurate oxygen measurement, the sensor data should be regularly adjusted.

The "slope" is the sensor current value with atmospheric oxygen saturation, 25 °C/77 °F and 1013 mbar/14.69 psi: nA/100 %. Only the "nA" measurement symbol appears on the display. This is technically not a "slope" but rather a calibration point. The value is provided with the intention of enabling the sensor to be compared with the datasheet values.

If the electrolyte, the membrane body, or both are replaced during maintenance of amperometric sensors, this change must be confirmed manually in the Maintenance menu:

Maintenance ▶ [I] [II] ... Oxy ▶ Membrane Body Replacement

→ Channel I/II Maintenance Functions, p. 159

Calibration is required after each membrane body replacement. This entry impacts on the accuracy of the calibration.

Recommendations for Calibration

For best performance, you should always calibrate in air. Compared to water, air is a calibration medium which is easy to handle, stable, and thus safe. In the most cases, however, the sensor must be removed for a calibration in air. In certain processes the sensor cannot be removed for calibration. Here, calibration must be performed directly in the process medium (e.g., with aeration).

For applications where concentration is measured, calibration in air has proved to be useful.

Common Combination: Process Variable / Calibration Mode

Measurement	Calibration
Saturation:	Water
Concentration:	Air

If there is a temperature difference between the calibration and the measured media, keep the sensor in the respective medium for an equalization period before and after calibration in order to obtain stable measured values.

The type of calibration pressure detection is preset during parameter setting:

Parameter Setting ▶ [I] [II] ... Oxy ▶ Pressure Correction → Pressure Correction, p. 102

Note: Amperometric sensors must be sufficiently polarized prior to calibration/adjustment. Follow the information on the sensor in the sensor user manual to ensure that the calibration is neither falsified nor unstable.

7.6.1 Calibration/Adjustment Methods

- In air/water: Automatic calibration in water/air
- Data entry: Data entry of premeasured sensors
- Product: Product calibration by entering saturation %air, concentration, or partial pressure
- Zero point: Zero correction
- Temperature: Temperature probe adjustment

7.6.2 Calibration Mode: In Air

Automatic Calibration in Air

The slope is corrected using the saturation value (100 % Air), similar to the air saturation of water. Since this analogy only applies to water-vapor saturated air (100 % relative humidity) and often the calibration air is less humid, the relative humidity of the calibration air must also be specified. If you do not know the exact value of the relative humidity of the calibration air, you can take the following reference values for a sufficiently precise calibration:

- Ambient air: 50 % rel. humidity (average)
- Bottled gas (synthetic air): 0 % rel. humidity

Calibration Procedure

Note: The sensor membrane must be dry. Be sure to keep temperature and pressure constant during calibration. If there is a temperature difference between calibration and measured media, the sensor requires some equalization time before and after calibration.

Calibration ▶ [I] [II] ... Oxy

When you access calibration, the calibration values selected in the calibration presettings are used. These settings can still be changed in the Calibration menu. If you do not want to perform calibration, use the left **softkey** to go back one level and abort the calibration.

01. Select "In Air" **Calibration Mode** and press **enter** to confirm.
02. Take the sensor out of the medium and clean it.
03. Carefully dab the membrane dry with a paper tissue.
04. Expose the sensor to air with a known water vapor saturation and press **enter** to confirm.
 - ✓ Display of selected calibration medium (air)
05. Enter relative humidity, e.g.: Ambient air: 50 %, Bottled gas: 0 %
06. **Enter Cal Pressure** : Enter the calibration pressure if "Manual" was configured.
07. Start with the **right softkey: Next**
 - ✓ Drift check is carried out.
 - The following parameters are displayed: Sensor Current, Calibration Pressure, and Response Time.
08. Exit calibration with the **right softkey: Next**.

Result

- ✓ The calibration record is displayed. By pressing the **right softkey: Adjust**, the calibration values obtained during calibration for calculation of the process variables are applied to the device. When using a Memosens sensor, the calibration values are saved in the sensor.

7.6.3 Calibration Mode: In Water

Automatic Calibration in Water

The slope is corrected using the saturation value (100 %) related to saturation with air.

Calibration Procedure

Note: Ensure sufficient sensor incident flow. (see the specifications of the oxygen sensor.) The calibration medium must be in equilibrium with air. Oxygen exchange between water and air is very slow. Therefore, it takes a relatively long time until water is saturated with atmospheric oxygen. If there is a temperature difference between calibration medium and measured medium, you must keep the sensor in the respective medium for several minutes before and after calibration.

Calibration ▶ [I] [II] ... Oxy

When you access calibration, the calibration values selected in the calibration presettings are used. These settings can still be changed in the Calibration menu. If you do not want to perform calibration, use the left **softkey** to go back one level and abort the calibration.

01. Select "In Water" Calibration Mode and press **enter** to confirm.
02. Take the sensor out of the medium and clean it.
03. Carefully dab the membrane dry with a paper tissue.
04. Expose the sensor to the calibration medium (air-saturated water), ensure sufficient incident flow, and press **enter** to confirm.
 - ✓ Display of selected calibration medium (air-saturated water)
05. Enter Cal Pressure : Enter the calibration pressure if "Manual" was configured.
06. Start with the **right softkey: Next**.
 - ✓ Drift check is carried out.
 - The following parameters are displayed: Sensor Current, Calibration Pressure, and Response Time.

The time for the sensor signal to stabilize can be shortened with the **left softkey: Exit** (without drift check: reduced accuracy of calibration values). The response time indicates how long the sensor needs until the sensor signal is stable. If the sensor signal or the measured temperature fluctuate considerably or the sensor is inadequately polarized, the calibration procedure is aborted after around 2 minutes. In this case, calibration needs to be restarted. Return the sensor to the process once this has been successfully completed. Make sure that the temperature of the sensor and the temperature of the calibration solution are not too far apart. The ideal temperature is 25 °C/77 °F.

07. Exit calibration with the **right softkey: Next**.

Result

- ✓ The calibration record is displayed. By pressing the **right softkey: Adjust**, the calibration values obtained during calibration for calculation of the process variables are applied to the device. When using a Memosens sensor, the calibration values are saved in the sensor.

7.6.4 Calibration Mode: Data Entry

Entry of values for slope and zero point of the sensor, related to 25 °C/77 °F, 1013 mbar/14.69 psi.

Slope = sensor current at 100 % atmospheric oxygen, 25 °C/77 °F, 1013 mbar/14.69 psi

Calibration Procedure

Calibration ▶ [I] [II] ... Oxy

When you access calibration, the calibration values selected in the calibration presets are used. These settings can still be changed in the Calibration menu. If you do not want to perform calibration, use the left **softkey** to go back one level and abort the calibration.

01. Select "Data Entry" Calibration Mode and press **enter** to confirm.
02. Remove the sensor and install the premeasured sensor.
03. Continue with the **right softkey: Next**.
04. Enter the zero point and slope measured values, and press **enter** to confirm.

Result

- ✓ The calibration record is displayed. By pressing the **right softkey: Adjust**, the calibration values obtained during calibration for calculation of the process variables are applied to the device. When using a Memosens sensor, the calibration values are saved in the sensor.

7.6.5 Calibration Mode: Product

Calibration by Sampling

If the sensor cannot be removed – e.g., for sterility reasons – its slope can be determined by "sampling". The current "Saturation" measured value is saved in the device for this purpose. A sample is taken directly afterward at the measuring point. The reference value is entered in the device. Stratos Multi calculates the sensor's correction values from the difference between the measured and reference values, and corrects the zero point in the event of small saturation values, the slope in the event of large values.

Note: Product calibration (saturation in liquids (standard) or concentration in gases or liquids (alternative)) can also be carried out using PROFINET acyclic services. → *PROFINET Commands, p. 111*

Calibration Procedure

NOTICE! Measure the reference value at temperature and pressure conditions similar to those of the process.

Calibration ▶ [I] [II] ... Oxy

When you access calibration, the calibration values selected in the calibration presets are used. These settings can still be changed in the Calibration menu. If you do not want to perform calibration, use the left **softkey** to go back one level and abort the calibration.

01. Select "Product" Calibration Mode and press **enter** to confirm.
 - ✓ Process variables saturation, concentration, and partial pressure configured as in Cal Presettings.
02. Change the process variable, if required.
03. Prepare for sampling.
04. Start with the **right softkey: Next**.

Product calibration is performed in 2 steps.

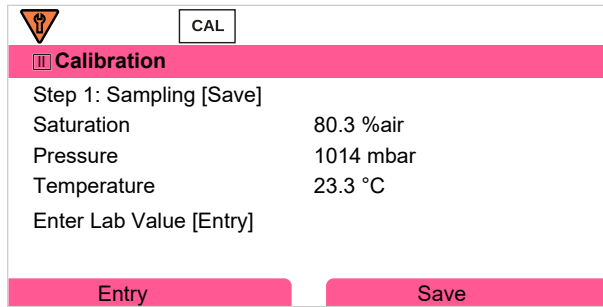

Step 1:

05. Take sample.

✓ The measured value and temperature at the time of sampling are displayed.

06. Save with the **right softkey: Save**.

✓ An information window is shown.

07. **Right softkey: Close**

08. As required, exit calibration by pressing the **left softkey: Back**.

Note: The icon  indicates that product calibration has not yet been completed.

Step 2: Lab value has been measured.

09. Open the Product Calibration menu again.

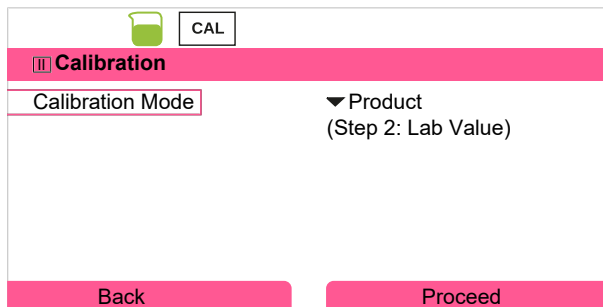

10. **Right softkey: Proceed**

11. Enter the lab value and press **enter** to confirm.

12. Confirm with the **right softkey: Next** or repeat calibration with the **left softkey: Cancel**.

Result

✓ The calibration record is displayed. By pressing the **right softkey: Adjust**, the calibration values obtained during calibration for calculation of the process variables are applied to the device. When using a Memosens sensor, the calibration values are saved in the sensor.

Exception: Sample value can be determined and entered on site:

13. Take sample.

✓ The measured value and temperature at the time of sampling are displayed.

14. **Left softkey: Entry**

15. Enter the lab value and press **enter** to confirm.

16. Confirm with the **right softkey: Next** or repeat calibration with the **left softkey: Cancel**.

Result

✓ The calibration record is displayed. By pressing the **right softkey: Adjust**, the calibration values obtained during calibration for calculation of the process variables are applied to the device. When using a Memosens sensor, the calibration values are saved in the sensor.

7.6.6 Calibration Mode: Zero Point

Zero Correction

For trace measurements below 500 ppb, the zero point should be calibrated. (TAN option FW-E015, "Oxygen Measurement in Low Oxygen Concentrations")

If a zero correction is performed, the sensor should remain for at least 10 to 60 minutes in the calibration medium (media containing CO₂; at least 120 min) to obtain stable, non-drifting values. During zero correction, a drift check is not performed.

Calibration Procedure

Calibration ▶ [I] [II] ... Oxy

When you access calibration, the calibration values selected in the calibration presettings are used. These settings can still be changed in the Calibration menu. If you do not want to perform calibration, use the left **softkey** to go back one level and abort the calibration.

01. Select "Zero Point" Calibration Mode and press **enter** to confirm.
02. Press the **right softkey: Next**.
 - ✓ Zero correction is carried out. The measured sensor current is displayed.
03. Enter the input current for the zero point.
04. Press the **right softkey: Next**.

Result

- ✓ The calibration record is displayed. By pressing the **right softkey: Adjust**, the calibration values obtained during calibration for calculation of the process variables are applied to the device. When using a Memosens sensor, the calibration values are saved in the sensor.

7.6.7 Calibration Mode: Temperature

Adjustment of the Temperature Probe

This function is used to adjust the individual temperature probe tolerances or cable lengths for the purpose of increasing the accuracy of the temperature measurement.

The adjustment requires an accurate measurement of the process temperature using a calibrated reference thermometer. The measurement error of the reference thermometer should be less than 0.1 K. Adjustment without an accurate measurement may result in falsification of the displayed measured value.

When using Memosens sensors, the adjustment value is saved in the sensor.

Calibration Procedure

Calibration ▶ [I] [II] [Sensor]

01. Select "Temperature" Calibration Mode and press **enter** to confirm.
02. Enter the measured process temperature and press **enter** to confirm.
 - ✓ The temperature offset is displayed.
03. Adjust the temperature probe with the **right softkey: Save**.

The current adjustment and temperature offset data can be displayed in the Diagnostics menu:

Diagnostics ▶ [I] [II] [Sensor] ▶ Temp. Offset Log

8 Diagnostics

8.1 Favorites Menu

Diagnostic functions can be accessed directly from measuring mode using the right *softkey*. For this purpose, the right *softkey* (1) must be assigned the function Favorites Menu :

Parameter Setting ▶ System Control ▶ Function Control → *Function Control*, p. 48

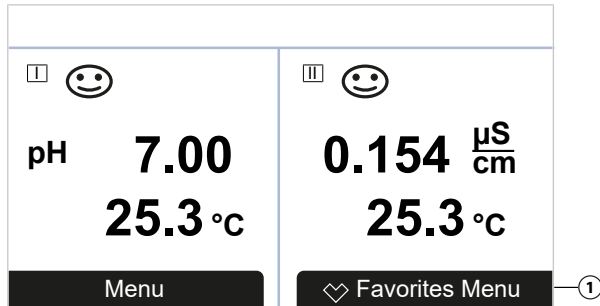

The "Favorites" are set in the Diagnostics menu.

Set a favorite:

01. From within measuring mode, press the *left softkey: Menu*.

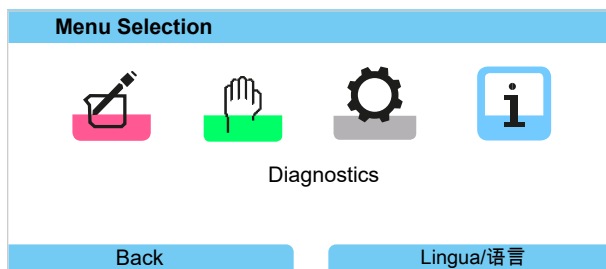

02. Using the right *arrow key*, select the **Diagnostics** menu and confirm with *enter*.

03. Select the desired submenu.

04. *Right softkey: Set Favorite*

- ✓ A heart icon appears to the left of the menu line. The softkey function changes to *Delete Favorite*.

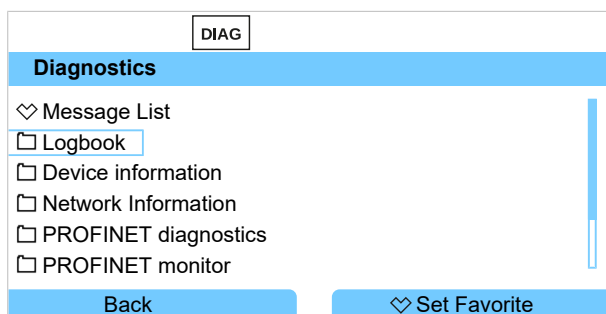

Delete a favorite:

05. Open the **Diagnostics** menu and select the Favorites menu.

06. *Right softkey: Delete Favorite*

- ✓ The heart icon disappears. The softkey function changes to *Set Favorite*.

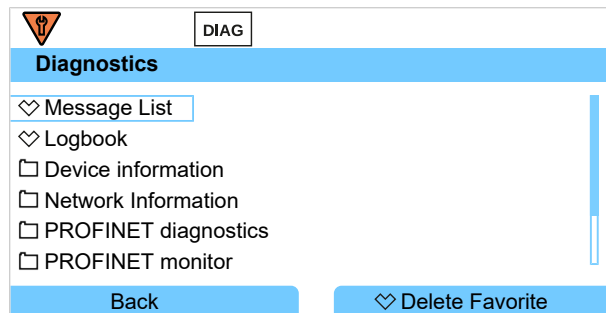

8.2 Diagnostic Functions

The diagnostic functions are matched to NAMUR recommendation NE 107.

8.2.1 Overview of Diagnostic Functions

In diagnostics mode, you can access the following submenus without interrupting the measurement:

Submenus	Description
Message List	Displays currently active messages in plain text. → <i>Messages, p. 154</i>
Logbook	Shows the last 100 events with date and time, e.g., calibrations, warning and failure messages, power failure, etc. With TAN option FW-E104, at least 20,000 entries can be recorded on a memory card (Data Card). → <i>Logbook, p. 154</i>
Device Information	Displays device information: Device type, serial number, hardware/firmware version → <i>Device Information, p. 155</i>
Network Information	Displaying the Current IP and MAC Addresses Diagnostics
PROFINET Diagnostics	Displays values for PROFINET communication → <i>Diagnostics, p. 115</i>
PROFINET Monitor	Displays the current AI, AO, DO values → <i>Diagnostics, p. 115</i>
Measurement Recorder	With enabled measurement recorder (TAN option FW-E103): Graphical display of recorded measured values → <i>Measurement Recorder (FW-E103), p. 250</i>
Device Test	Display device diagnostics, perform a display or keypad test → <i>Device Test, p. 155</i>
Meas. Point Description	Display tag number and notes. → <i>Measuring Point Description, p. 156</i>
[I] [II] [Sensor]	Depending on sensor type, e.g., sensor information, sensor monitor, sensor diagram, calibration/adjustment record → <i>Channel I/II Diagnostic Functions, p. 156</i>

8.2.2 Messages

All values determined by the measuring module or sensor can generate messages.

Configuring Messages

Process variable limits for the monitoring range can be selected in the **Messages** submenu:



Parameter Setting ▶ [I] [II] [Sensor] ▶ Messages ▶ Messages [Process Variable] ▶ Monitoring

- Max. Device Limits: Messages are generated when the process variable is outside the measuring range. The “failure” or “out of specification” icons are shown; the corresponding relay contact is enabled. The current outputs can signal a 22-mA message (user-defined).
- Variable Limits: Upper and lower limits at which a message is generated can be defined for the “Failure” and “Out of Specification” messages.

Note: If display color NE107 is selected in Parameter Setting (factory setting), measured values are backlit in accordance with their NAMUR color when NAMUR messages are available.

Parameter Setting ▶ General ▶ Display

Displaying Messages

01. Go to the Diagnostics menu if the “failure” , “maintenance required” , or “out of specification”  icons are flashing on the display: Menu Selection ▶ Diagnostics ▶ Message List
 ✓ All active messages are displayed in the **Message List** menu item with the following information: Error number, type (failure, maintenance required, out of specification), channel, message text.

02. You can scroll forward and backward using the **up/down arrow keys**.





The error message disappears from the display around 2 s after the error is cleared.

An overview of message texts with notes on troubleshooting can be found in the “Troubleshooting” chapter. → *Malfunction States, p. 161*

8.2.3 Logbook

The logbook shows the last 100 events with message number, date, and time directly on the device, e.g., calibrations, NAMUR messages, power failure. Messages that occur during the function check (HOLD) operating state are not saved.

Access in: Diagnostics ▶ Logbook

DIAG			
Logbook			
F240	12/11/19	08:33	 Cal Mode is Active
F240	12/11/19	08:21	 Cal Mode is Active
F032	12/11/19	08:13	 Sensor Identified
F029	12/11/19	08:13	 No Sensor Connected
F029	12/11/19	08:05	 No Sensor Connected
F227	12/11/19	08:05	Power Supply ON

You can scroll forward and backward in the logbook using the **up/down arrow keys**.

When using the Data Card and TAN option FW-E104, 20,000 entries or more can be stored on the card, depending on the memory load.

Select whether to record Failure and/or Maintenance Required messages in the logbook in the system control:

Parameter Setting ▶ System Control ▶ Logbook → *Logbook, p. 49*

Logbook entries can also be deleted here.

8.2.4 Device Information

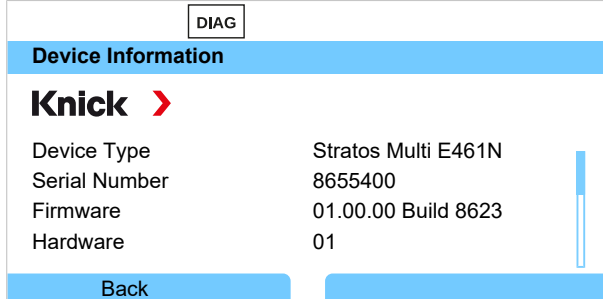

The following device information is displayed for the basic unit and any inserted module:

- Device type
- Serial number
- Firmware versions
- Hardware versions
- Bootloader

Access in: Diagnostics ▶ Device Information

8.2.5 Device Test

Device Diagnostics

Stratos Multi periodically performs a self-test in the background.

The results can be viewed in Diagnostics ▶ Device Test ▶ Device Diagnostics

If a memory card is inserted, the card type and available memory are also displayed.

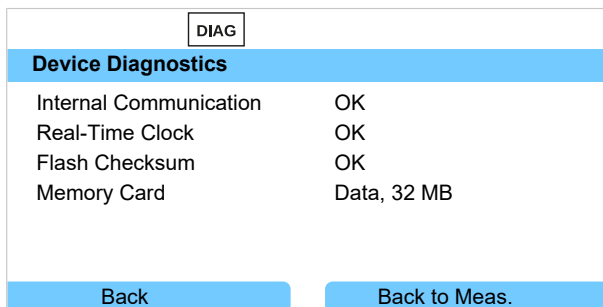

Display Test

If you select Diagnostics ▶ Device Test ▶ Display Test, the device performs a display test. The display changes color from red to green to blue.

Keypad Test

You can test the device keypad by selecting Diagnostics ▶ Device Test ▶ Keypad Test.

01. Press all keys one after the other.
 - ✓ A green checkmark shows that a key functions properly.
02. Press the *left softkey* twice to exit.

8.2.6 Measuring Point Description

Diagnostics ▶ Meas. Point Description

Display of tag number and notes

Entry in menu Parameter Setting ▶ System Control ▶ Meas. Point Description

→ *Measuring Point Description, p. 48*

8.2.7 Channel I/II Diagnostic Functions

The submenus vary depending on the sensor type. Key functions are set out below.

Sensor Information

Note: Function active for digital sensors.

The Sensor Information submenu shows data from the currently connected digital sensor, e.g., manufacturer, order no., serial no., firmware and hardware version, last calibration, operating time:

Diagnostics ▶ [I] [II] [Sensor] ▶ Sensor Information

Sensor Monitor

For diagnostic purposes, the raw measured values for the sensor type are displayed in the sensor monitor.

Diagnostics ▶ [I] [II] [Sensor] ▶ Sensor Monitor

Sensor Diagram

Note: Function active for pH and oxygen sensors.

The sensor diagram clearly indicates the status of the parameters in the connected sensor, including the calibration timer.

Inactive parameters are shown in gray and set to 100 % (e.g., disabled calibration timer).

The parameter values should lie between the outer (100 %) and inner (50 %) polygon. A warning signal flashes if a value drops below the inner polygon (<50 %).

Access in: Diagnostics ▶ [I] [II] [Sensor] ▶ Sensor Diagram

Display example:

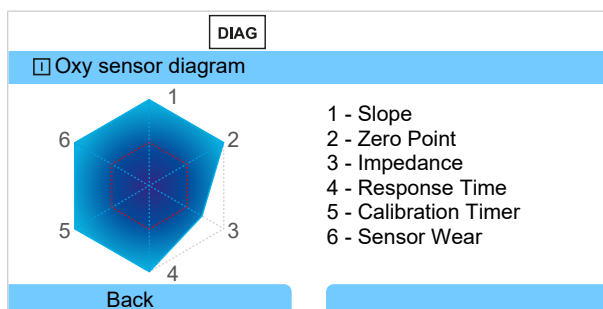

Calibration/Adjustment Record

The calibration/adjustment record shows the data from the last calibration/adjustment performed on the currently connected sensor.

Access in: Diagnostics ▶ [I] [II] [Sensor] ▶ Cal/Adj Record [Process Variable]

Temp. Offset Log

The temp. offset log shows the data from the last temperature equalization performed on the currently connected sensor.

Access in: Diagnostics ▶ [I] [II] [Sensor] ▶ Temp. Offset Log

Sensor Wear Monitor

Note: Function active for digital sensors.

The sensor wear monitor shows the sensor operating time and the maximum temperature during the operating time, as well as wear and the forecast remaining time. When using oxygen sensors, the number of membrane replacements and calibrations is also displayed:

Diagnostics ▶ [I] [II] [Sensor] ▶ Sensor Wear Monitor

DIAG	
Sensor Wear Monitor	
Operating Time	68 d
Wear	9.5 %
Remaining Lifetime	661 d
Max. Temperature	32 °C

Back Back to Meas.

Load Matrix

Note: Function active for ISM pH/ORP sensors and amperometric ISM oxygen sensors.

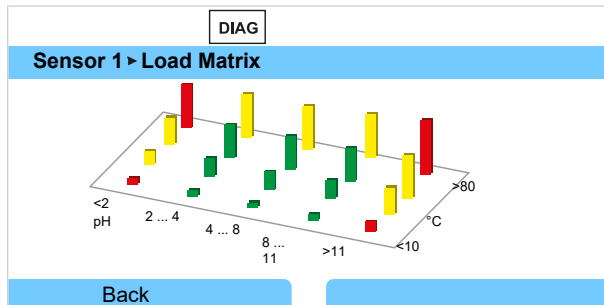

Bar Color

Green: The area that puts the least load on the sensor.

Yellow: The area that puts more load on the sensor.

Red: The area that puts the most load on the sensor.

The bar height indicates the duration of the load.

See also

→ *Digital ISM Sensors (FW-E053), p. 248*

Statistics

Note: Function active for ISM pH/ORP sensors and amperometric ISM oxygen sensors.

The statistics data provides information on the sensor product life cycle: Data from the first adjustment and the three most recent calibrations/adjustments is displayed. This data can be used to assess the performance of the sensor over its service life.

Use the **right softkey** to switch between a graphical display and a list.

See also

→ *Digital ISM Sensors (FW-E053), p. 248*

→ *Calibration/Adjustment, p. 121*

9 Maintenance Functions

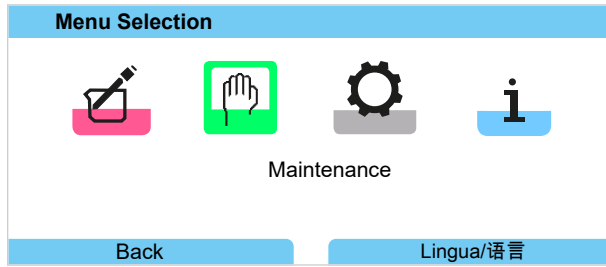

Note: Function check (HOLD) is active. PROFINET communication and the relay contacts/current outputs behave in accordance with the parameter settings. Return to measuring mode to exit the function check, e.g., with the **right softkey: Back to Meas.**

9.1 Overview of Maintenance Functions

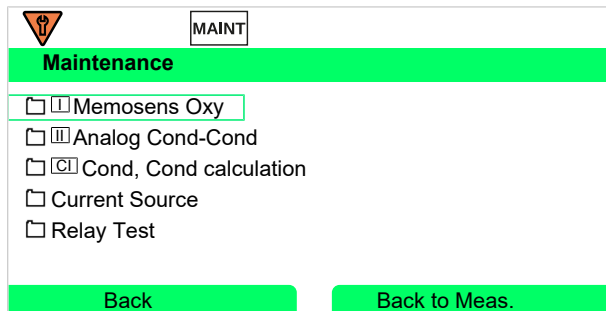

The Maintenance menu provides various functions for checking the device function:

Submenus	
Open/Close Memory Card	Only if Data Card is inserted → <i>Memory Card, p. 182</i>
[I] [II] [Sensor]	Depending on sensor type, e.g.: sensor monitor → <i>Channel I/II Maintenance Functions, p. 159</i>
[CI] [CII] Cond, Cond Calculation	When using the Cond/Cond calculation block to calculate pH value upstream and downstream of an ion exchanger: Confirm ion exchanger replacement. → <i>Calculation Blocks (FW-E020), p. 244</i>
Current Source	Function test: manual control of current outputs in full range → <i>Current Source, p. 160</i>
Relay Test	Function test of relay contacts → <i>Relay Test, p. 160</i>

9.2 Channel I/II Maintenance Functions

	Memosens/analog pH/Cond/Condl	Memosens Oxy	SE740	ISM Oxy ¹⁾	ISM pH ¹⁾
Sensor monitor	+	+	+	+	+
Autoclaving counter	+ ²⁾		+	+	+
Membrane body replacement		+		+	
Interior body replacement				+	

9.2.1 Sensor Monitor

Maintenance ▶ [I] [II] Sensor ▶ Sensor Monitor

Display of the currently measured values (sensor monitor) with function check (HOLD mode activated) enabled:

Since the instrument is in function check (HOLD) mode, certain media can be used to validate the sensor and check the measured values without affecting the signal outputs.

9.2.2 Autoclaving Counter

If the autoclaving counter has been enabled in the Parameter Setting menu

Sensor Data ▶ Sensor Monitoring Details, it must be manually incremented in the Maintenance menu after each autoclaving process:

01. Maintenance ▶ [I] [II] [Sensor] ▶ Autoclaving Counter
02. **Right softkey:** Cycles+1
03. A confirmation prompt appears: Select "Yes" with the **left arrow key**.
04. Close the window by pressing the **right softkey**.

9.2.3 Electrolyte Replacement/Membrane Body Replacement

If the electrolyte or the membrane body of a Memosens oxygen sensor are replaced during maintenance of a sensor, this must be confirmed manually in the Maintenance menu:

01. Maintenance ▶ [I] [II] Memosens Oxy ▶ Membrane Body Replacement
✓ A text window appears: Membrane Body or Electrolyte Replaced?
02. **Left arrow key:** Yes
03. Confirm with **enter**.

The counter automatically resets on confirmation of the completed check.

Note: The digital SE740 optical oxygen sensor automatically recognizes replacement of the membrane body. The counter is automatically incremented.

¹⁾ With TAN option FW-E053

²⁾ Only with Memosens pH/ORP

9.2.4 Replacing the Membrane Body/Interior Body

If the membrane body or the interior body of an ISM oxygen sensor are replaced during maintenance of a sensor, this must be confirmed manually in the Maintenance menu:

01. Maintenance ▶ [II] ISM Oxy ▶ Membrane Body Replacement / Interior Body Replacement
02. *Enter the date and serial number using the arrow keys.*
03. In each case, press *enter* to confirm.
04. *Right softkey: Apply*

The maximum permitted number of membrane body/interior body replacements can be specified in Parameter Setting:

Parameter Setting ▶ [II] ISM Oxy ▶ Sensor Data ▶ Sensor Monitoring Details

9.3 Manual Function Check

9.3.1 Current Source

For testing purposes, the output current can be manually specified (range 0 ... 22 mA):

Maintenance ▶ Current Source

01. Select the current output.
02. Enter a valid current value for the respective output using the *arrow keys*.
03. Confirm with *enter*.
 - ✓ For checking purposes, the actual output current is shown in the bottom right corner of the display.

9.3.2 Relay Test

Maintenance ▶ Relay Test

When you access this menu, the function of the relay contacts is checked. The relays can be set to manual to check the wiring.

10 Troubleshooting



10.1 Malfunction States

Messages and errors are displayed with the corresponding NAMUR icon and the measurement display of the corresponding channel changes color.

The message is logged, with time and date, in the logbook. → *Logbook, p. 154*

If messages are set to current outputs or relay contacts, these are activated after the user-defined delay has expired.

Displaying Messages



- Go to the Diagnostics menu if the “failure” , “maintenance required” , or “out of specification”  icons are flashing on the display: **Menu Selection ▶ Diagnostics ▶ Message List**
 ✓ All active messages are displayed in the **Message List** menu item with the following information: Error number, type (failure, maintenance required, out of specification), channel, message text.

- You can scroll forward and backward using the **up/down arrow keys**.

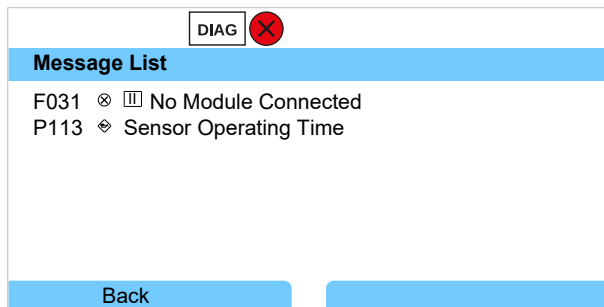
The error message disappears from the display around 2 s after the error is cleared.



10.2 Error Messages

Error Type		Display Color in Accordance with NE107
	Failure	Red
	Maintenance required	Blue
	Out of specification	Yellow
Info	Info text, appears directly in the relevant menu	
par	User-defined error type: failure or maintenance required	

General Error Messages

Error	Possible Causes	Remedy
Display is blank	No power supply	Check the power supply or provide a suitable power supply for the device.
	Display auto-off enabled.	Press any key to wake the display following a possible auto-off.
No measurement, no error message	Sensor or module incorrectly connected.	Check the sensor connection/install the module properly.
	Measurement display not configured.	Configure the measurement display: Parameter Setting ▶ General ▶ Measurement Display
No connection via PROFINET	RJ45 connector or Y cable not correctly connected.	Check the connection. Diagnostics ▶ PROFINET Diagnostics : Phy Link State: No Link Connect the plug correctly.
	PROFINET not enabled in the Stratos Multi.	Parameter Setting ▶ PROFINET ▶ Usage : On
	Incorrect IP address.	Diagnostics ▶ PROFINET Diagnostics : Comm State: Stop Check and correct the address.
	Incorrect or non-unique device name (name of station)	Diagnostics ▶ PROFINET Diagnostics : Comm State: Stop Check and correct the name of station.
	Incorrect GSDML used.	Check GSDML, select correct GSDML.
Device does not respond to key presses.	Key lock is active (F234)	Disable key lock via PCS: Slot 1, subslot 1, index 1

Error No.	Type	Message Text	Notes/Solution
F008	⊗	Adjustment Data	Error in the adjustment data: Switch device off (approx. 10 s). If the message persists, send in the device.
F009	⊗	Firmware Error	Error in the firmware: Switch device off (approx. 10 s). Reload the firmware. → <i>Firmware Update (FW-E106)</i> , p. 252 If the message persists, send in the device.
F029	⊗	No Sensor Connected	The sensor is not recognized: - Check connections. - Check cables. Replace as required. - Check sensor. Replace as required.
F030	⊗	Wrong Sensor Connected	The connected digital sensor does not match the configuration: - Connect correct sensor. - Adjust the process variable. → <i>Sensor Selection [I] [II]</i> , p. 66
F031	⊗	No Module Connected	No module is recognized. Possible causes: - No module installed. - Wrong module selected. - Module faulty. Install the module properly and select it in the parameter settings.
F033	Info	Sensor Removed	The sensor cannot be found. Possible causes: - Sensor was removed. - Connections/cables faulty. Connect an appropriate sensor and adjust the configuration as necessary.
F036	⊗	Sensor Devaluated	Sensor devaluated. Replace sensor.
F038	⊗	Sensor Defective	Faulty sensor. Replace sensor.































Error No.	Type	Message Text	Notes/Solution
F039	Info	Door Open	The enclosure was not mounted correctly: Check the enclosure, as necessary tighten the enclosure screws. → <i>Enclosure, Mounting Possibilities, p. 18</i>
F201	⊗	KBUS Error	Internal communication error: Switch device off (approx. 10 s). If the message persists, send in the device.
F202	⊗	System Failure	Internal system error: Switch device off (approx. 10 s). If the message persists, send in the device.
F203	⊗	Inconsistent Parameter Setting	The configuration of the measuring channel operating mode is inconsistent: Check and correct the configuration.
F204	⊗	Data Loss System Control Param.	Data error in the configuration: Reset to factory settings and fully reconfigure.
F212	⊗	Time/Date	The time and date still need to be set. Parameter Setting ▶ System Control ▶ Time/Date
F215	↔	Memory Card Full	The memory card is full. Use a new memory card.
F229	Info	Wrong Passcode	An incorrect passcode was entered. → <i>Passcode Entry, p. 50</i>
F234	Info	Key Lock is Active	Disable key lock via PCS: Slot 1, subslot 1, index 1





Current Output/Relay Contacts

Error No.	Type	Message Text	Notes/Solution
B070	⊗	Current I1 Span	Current output 1: The selected span is too small/too big: Parameter Setting ▶ Inputs/Outputs ▶ Current Outputs ▶ Current Output I1 Check start/end.
B071	⊗	Current I1 < 0/4 mA	Current output 1: The current is below the permissible limit.
B072	⊗	Current I1 > 20 mA	Current output 1: The current is above the permissible limit.
B073	⊗	Current I1 Load Error	Current output 1: The current loop has been interrupted (open circuit) or the load is too high: Deactivate or short-circuit unused current outputs.
B074	⊗	Current I1 Parameter	Current output 1: Check the configuration.
B075	⊗	Current I2 Span	Current output 2: The selected span is too small/too big: Parameter Setting ▶ Inputs/Outputs ▶ Current Outputs ▶ Current Output I2 Check start/end.
B076	⊗	Current I2 < 0/4 mA	Current output 2: The current is below the permissible limit.
B077	⊗	Current I2 > 20 mA	Current output 2: The current is above the permissible limit.
B078	⊗	Current I2 Load Error	Current output 2: The current loop has been interrupted (open circuit) or the load is too high: Deactivate or short-circuit unused current outputs.
B079	⊗	Current I2 Parameter	Current output 2: Check the configuration.
B220	⊗	Flow LO	Value below configured monitoring limit
B221	⊗	Flow HI	Value above configured monitoring limit























pH, ORP

Error No.	Type	Message Text	Notes/Solution
P001	⊗	Configuration Data Loss	Data error in the configuration: Fully reconfigure the device.
P008	⊗	Adjustment Data	Error in the adjustment data: Switch device off (approx. 10 s). If the message persists, send in the device.
P009	⊗	Firmware Error	Error in the firmware: Switch device off (approx. 10 s). Reload the firmware. → <i>Firmware Update (FW-E106)</i> , p. 252 If the message persists, send in the device.
P010	⊗	pH Range	Measuring range exceeded. Possible causes: Sensor not or incorrectly connected, sensor faulty, cable faulty, incorrect temperature detector selected, temperature detector faulty. With MK-PH015 module without connection to solution ground: No jumper between terminals B and C. → <i>pH Analog Wiring Examples</i> , p. 202
P011	⊗	pH LO_LO	Value below configured monitoring limit
P012	⚠	pH LO	Value below configured monitoring limit
P013	⚠	pH HI	Value above configured monitoring limit
P014	⊗	pH HI_HI	Value above configured monitoring limit
P015	⊗	Temperature Range	Measuring range exceeded. Possible causes: Sensor not or incorrectly connected, cable faulty, incorrect temperature probe selected.
P016	⊗	Temperature LO_LO	Value below configured monitoring limit
P017	⚠	Temperature LO	Value below configured monitoring limit
P018	⚠	Temperature HI	Value above configured monitoring limit
P019	⊗	Temperature HI_HI	Value above configured monitoring limit
P020	⊗	ORP Range	Measuring range exceeded. Possible causes: no ORP sensor connected, sensor incorrectly connected, sensor faulty, cable faulty. On pH measurement with MK-PH015 module: No jumper between terminals B and C. → <i>pH Analog Wiring Examples</i> , p. 202
P021	⊗	ORP LO_LO	Value below configured monitoring limit
P022	⚠	ORP LO	Value below configured monitoring limit
P023	⚠	ORP HI	Value above configured monitoring limit
P024	⊗	ORP HI_HI	Value above configured monitoring limit
P025	⊗	rH Range	Measuring range exceeded. Possible causes: no pH/ORP combo sensor connected, sensor incorrectly connected, cable faulty.
P026	⊗	rH LO_LO	Value below configured monitoring limit
P027	⚠	rH LO	Value below configured monitoring limit
P028	⚠	rH HI	Value above configured monitoring limit
P029	⊗	rH HI_HI	Value above configured monitoring limit
P045	⊗	pH Voltage Range	Measuring range exceeded. Possible causes: Sensor not or incorrectly connected, sensor faulty, cable faulty.
P046	⊗	pH Voltage LO_LO	Value below configured monitoring limit
P047	⚠	pH Voltage LO	Value below configured monitoring limit
P048	⚠	pH Voltage HI	Value above configured monitoring limit

Error No.	Type	Message Text	Notes/Solution
P049		pH Voltage HI_HI	Value above configured monitoring limit
P060		Sensoface: Slope	 Incorrect adjustment or worn/faulty sensor: Calibrate/adjust sensor, check for correct buffer solutions and temperature. Replace the sensor as required.
			 Sensor soon worn: Replace the sensor soon.
P061		Sensoface: Zero Point	 Incorrect adjustment or worn/faulty sensor: Calibrate/adjust sensor, check for correct buffer solutions and temperature. Replace the sensor as required.
			 Sensor soon worn: Replace the sensor soon.
P062		Sad Sensoface  Reference Impedance	Reference impedance outside limits. Possible causes: Sensor cable faulty, sensor faulty. With MK-PH015 module without connection to solution ground: No jumper between terminals B and C. → <i>pH Analog Wiring Examples, p. 202</i>
P063		Sad Sensoface  Glass Impedance	Glass impedance outside limits. Possible causes: Sensor cable faulty, sensor faulty: As required, calibrate/adjust sensor or replace.
P064	par	Sad Sensoface:  Response Time	Response time too long. Possible causes: Sensor worn out. Adjustment not carried out properly (unsteady): Repeat calibration/adjustment. Replace the sensor as required.
P065		Sad Sensoface  Calibration Timer	Calibration timer has expired: Check calibration timer setting, perform calibration/adjustment.
P069		Sad Sensoface  Calimatic	Check calibration. As required, recalibrate/readjust sensor or replace.
P070		Sad Sensoface  Wear	Sensor is worn (100 %): Replace sensor.
P071	par	Sad Sensoface:  Leakage Current	ISFET sensor faulty: Replace sensor.
P072		Sad Sensoface  Operating Point	ISFET sensor: Operating point out of range. Readjust ISFET zero point, replace sensor as required.
P073	par	TTM Maintenance Timer	ISM Sensor: Maintenance timer expired: Clean/maintain the sensor. Then reset the counter in the Maintenance menu: Maintenance ▶ [II] ISM pH ▶ Sensor Maintenance
P074		Sad Sensoface  Zero Offset ORP	ORP zero offset is too large: Readjust ORP, replace sensor as required.
P075	par	DLI lifetime indicator	Operating time of ISM sensor exceeded: Replace sensor.
P090		Error in Buffer Table	The conditions for the buffer table were not adhered to: Check and, as necessary, correct the configuration. → <i>pH Buffer Table: Entry of Individual Buffer Set (FW-E002), p. 235</i>
P110		CIP Counter	Configured number of CIP cycles exceeded: As required, calibrate/adjust sensor or replace.
P111		SIP Counter	Configured number of SIP cycles exceeded: As required, calibrate/adjust sensor or replace.
P112		Autoclaving Counter	Configured number of autoclavings exceeded: As required, recalibrate/ readjust sensor or replace.
P113	par	Sensor Operating Time	Sensor operating time exceeded: Replace sensor.
P120		Wrong Sensor (Sensor Check)	If sensor check is active: An impermissible sensor is connected to the device: Connect correct sensor or disable function.
P121		Sensor Error (Factory Settings)	The digital sensor indicates an error. The sensor no longer works properly. Replace sensor.

Error No.	Type	Message Text	Notes/Solution
P122		Sensor Memory (Cal Data)	The digital sensor indicates an error. The calibration data are defective: Recalibrate/readjust sensor.
P201		Cal: Temperature	The calibration temperature is impermissible: Check the calibration temperature. Note the information in the Calibration chapter. → <i>pH Process Variable Calibration/Adjustment, p. 122</i>
P202	Info	Cal: Buffer Unknown	Calibration error with automatic Calimatic calibration: Buffer not recognized. Possible causes: Incorrect buffer set selected. Buffer corrupted. Sensor faulty: Check calibration. Note the information in the Calibration chapter. → <i>Calibration Mode: Calimatic, p. 124</i>
P203	Info	Cal: Identical Buffers	Calibration error with automatic Calimatic calibration: The same buffer was used. The sensor or the sensor cable may be faulty.
P204	Info	Cal: Buffers Interchanged	Calibration error during manual calibration: Buffer order differs from specified order. Repeat calibration and adhere to the specified order. → <i>Calibration Mode: Manual, p. 126</i>
P205	Info	Cal: Sensor Unstable	The drift criterion was not adhered to during calibration. Possible causes: improper calibration, sensor cable/connection faulty, sensor worn. Check the sensor and calibration and repeat as required. Otherwise, replace the sensor.
P206		Cal: Slope	Slope out of permissible range: Repeat calibration/adjustment or replace sensor.
P207		Cal: Zero Point	Zero point out of permissible range: Repeat calibration/adjustment or replace sensor.
P208		Cal: Sensor Failure	Replace sensor.

Calculation Block pH/pH

Error No.	Type	Message Text	Notes/Solution
A001		Configuration Data Loss	Data error in the configuration: Fully reconfigure the device.
A010		pH Diff Range	pH value difference. Max/min device limits exceeded: - Check both pH values. - Check sensor/cable connections.
A011		pH Diff LO_LO	Value below configured monitoring limit
A012		pH Diff LO	Value below configured monitoring limit
A013		pH Diff HI	Value above configured monitoring limit
A014		pH Diff HI_HI	Value above configured monitoring limit
A015		Temperature Diff Range	Temperature value difference. Max/min device limits exceeded: - Check both temperature values. - Check sensor/cable connections.
A016		Temperature Diff LO_LO	Value below configured monitoring limit
A017		Temperature Diff LO	Value below configured monitoring limit
A018		Temperature Diff HI	Value above configured monitoring limit
A019		Temperature Diff HI_HI	Value above configured monitoring limit
A020		ORP Diff Range	ORP value difference. Max/min device limits exceeded: - Check both ORP values. - Check sensor/cable connections.
A021		ORP Diff LO_LO	Value below configured monitoring limit
A022		ORP Diff LO	Value below configured monitoring limit
A023		ORP Diff HI	Value above configured monitoring limit
A024		ORP Diff HI_HI	Value above configured monitoring limit
A045		pH Voltage Diff Range	pH voltage difference. Max/min device limits exceeded: - Check both pH voltage values. - Check sensor/cable connections.
A046		pH Voltage Diff LO_LO	Value below configured monitoring limit
A047		pH Voltage Diff LO	Value below configured monitoring limit
A048		pH Voltage Diff HI	Value above configured monitoring limit
A049		pH Voltage Diff HI_HI	Value above configured monitoring limit
A200		Param. Calculation Block	Check the configuration: Parameter Setting ▶ System Control ▶ Calculation Blocks

Conductivity (Contacting)

Error No.	Type	Message Text	Notes/Solution
C001		Configuration Data Loss	Data error in the configuration: Fully reconfigure the device.
C008		Adjustment Data	Error in the adjustment data: Switch device off (approx. 10 s). If the message persists, send in the device.
C009		Firmware Error	Error in the firmware: Switch device off (approx. 10 s). Reload the firmware. → <i>Firmware Update (FW-E106)</i> , p. 252 If the message persists, send in the device.
C010		Conductivity Range	Measuring range exceeded. Possible causes: Sensor not/incorrectly connected, cable incorrectly connected/faulty, range incorrectly specified, incorrect cell constant set. Parameter Setting ▶ [II] Analog Cond ▶ Sensor Data
C011		Conductivity LO_LO	Value below configured monitoring limit
C012		Conductivity LO	Value below configured monitoring limit
C013		Conductivity HI	Value above configured monitoring limit
C014		Conductivity HI_HI	Value above configured monitoring limit
C015		Temperature Range	Measuring range exceeded. Possible causes: Sensor not/incorrectly connected, cable incorrectly connected/faulty, range incorrectly specified, incorrect temperature probe selected. Parameter Setting ▶ [II] Analog Cond ▶ Sensor Data
C016		Temperature LO_LO	Value below configured monitoring limit
C017		Temperature LO	Value below configured monitoring limit
C018		Temperature HI	Value above configured monitoring limit
C019		Temperature HI_HI	Value above configured monitoring limit
C020		Resistivity Range	Measuring range exceeded. Possible causes: Sensor not/incorrectly connected, cable incorrectly connected/faulty, range incorrectly specified, incorrect cell constant set. Parameter Setting ▶ [II] Analog Cond ▶ Sensor Data
C021		Resistivity LO_LO	Value below configured monitoring limit
C022		Resistivity LO	Value below configured monitoring limit
C023		Resistivity HI	Value above configured monitoring limit
C024		Resistivity HI_HI	Failure: Value above configured monitoring limit
C025		Concentration Range	Measuring range exceeded. Possible causes: Sensor not/incorrectly connected, cable incorrectly connected/faulty, range incorrectly specified, incorrect cell constant set. Parameter Setting ▶ [II] Analog Cond ▶ Sensor Data
C026		Concentration LO_LO	Value below configured monitoring limit
C027		Concentration LO	Value below configured monitoring limit
C028		Concentration HI	Value above configured monitoring limit
C029		Concentration HI_HI	Value above configured monitoring limit

Error No.	Type	Message Text	Notes/Solution
C040	⊗	Salinity Range	Measuring range exceeded. Possible causes: Sensor not/incorrectly connected, cable incorrectly connected/faulty, incorrect cell constant set. Parameter Setting ▶ [!] Analog Cond ▶ Sensor Data
C041	⊗	Salinity LO_LO	Value below configured monitoring limit
C042	⚠	Salinity LO	Value below configured monitoring limit
C043	⚠	Salinity HI	Value above configured monitoring limit
C044	⊗	Salinity HI_HI	Value above configured monitoring limit
C045	⊗	Conductance Range	Value above range limit. Possible causes: Sensor not/incorrectly connected, incorrect sensor for range, cable faulty (short circuit).
C060	⊕	Sad Sensoface Polarization	The sensor is polarized. Sensor is not suitable for the range or the process medium. Connect a suitable sensor.
C062	⊕	Sad Sensoface Cell Constant	Incorrect cell constant set, incorrect adjustment: Repeat calibration/adjustment. Replace the sensor as required.
C070	⊗	TDS Range	Measuring range exceeded. Possible causes: Sensor not/incorrectly connected, cable incorrectly connected/faulty, incorrect cell constant set.
C071	⊗	TDS LO_LO	Value below configured monitoring limit
C072	⚠	TDS LO	Value below configured monitoring limit
C073	⚠	TDS HI	Value above configured monitoring limit
C074	⊗	TDS HI_HI	Value above configured monitoring limit
C090	par	USP Limit	The configured USP limit was exceeded.
C091	par	Reduced USP Limit	The configured reduced USP limit was exceeded.
C110	⊕	CIP Counter	Configured number of CIP cycles exceeded: As required, calibrate/adjust sensor or replace.
C111	⊕	SIP Counter	Configured number of SIP cycles exceeded: As required, calibrate/adjust sensor or replace.
C113	⊕	Sensor Operating Time	Sensor operating time exceeded: Replace sensor.
C121	⊗	Sensor Error (Factory Settings)	The digital sensor indicates an error. The sensor no longer works properly. Replace sensor.
C123	⊕	New Sensor, Adjustment Required	A new digital sensor was connected. It must now be adjusted:
C204	Info	Cal: Sensor Unstable	The drift criterion was not adhered to during calibration. Possible causes: Improper calibration. Sensor cable/connection faulty. Sensor worn out. Check the sensor and calibration and repeat as required. Otherwise, replace the sensor.
C205	Info	Cal: Sensor Failure	Replace sensor.

Cond/Cond Calculation Block

Error No.	Type	Message Text	Notes/Solution
E001	⊗	Configuration Data Loss	Data error in the configuration: Fully reconfigure the device.
E010	⊗	Conductivity Diff Range	Conductivity value difference. Max/min device limits exceeded: - Check both conductivity values. - Check sensor/cable connections.
E011	⊗	Conductivity Diff LO_LO	Value below configured monitoring limit
E012	⚠	Conductivity Diff LO	Value below configured monitoring limit
E013	⚠	Conductivity Diff HI	Value above configured monitoring limit
E014	⊗	Conductivity Diff HI_HI	Value above configured monitoring limit
E015	⊗	Temperature Diff Range	Temperature value difference. Max/min device limits exceeded: - Check both temperature values. - Check sensor/cable connections.
E016	⊗	Temperature Diff LO_LO	Value below configured monitoring limit
E017	⚠	Temperature Diff LO	Value below configured monitoring limit
E018	⚠	Temperature Diff HI	Value above configured monitoring limit
E019	⊗	Temperature Diff HI_HI	Value above configured monitoring limit
E020	⊗	Resistivity Diff Range	Resistivity difference. Max/min device limits exceeded: - Check both resistance values. - Check sensor/cable connections.
E021	⊗	Resistivity Diff LO_LO	Value below configured monitoring limit
E022	⚠	Resistivity Diff LO	Value below configured monitoring limit
E023	⚠	Resistivity Diff HI	Value above configured monitoring limit
E024	⊗	Resistivity Diff HI_HI	Value above configured monitoring limit
E030	⊗	RATIO Range	Ratio. Min/max device limits exceeded: - Check both conductivity values.
E031	⊗	RATIO LO_LO	Value below configured monitoring limit
E032	⚠	RATIO LO	Value below configured monitoring limit
E033	⚠	RATIO HI	Value above configured monitoring limit
E034	⊗	RATIO HI_HI	Value above configured monitoring limit
E035	⊗	PASSAGE Range	Passage. Min/max device limits exceeded: - Check both conductivity values.
E036	⊗	PASSAGE LO_LO	Value below configured monitoring limit
E037	⚠	PASSAGE LO	Value below configured monitoring limit
E038	⚠	PASSAGE HI	Value above configured monitoring limit
E039	⊗	PASSAGE HI_HI	Value above configured monitoring limit
E045	⊗	REJECTION Range	Rejection. Min/max device limits exceeded: - Check both conductivity values.
E046	⊗	REJECTION LO_LO	Value below configured monitoring limit
E047	⚠	REJECTION LO	Value below configured monitoring limit
E048	⚠	REJECTION HI	Value above configured monitoring limit

Error No.	Type	Message Text	Notes/Solution
E049	⊗	REJECTION HI_HI	Value above configured monitoring limit
E050	⊗	DEVIATION Range	Deviation. Min/max device limits exceeded: - Check both conductivity values.
E051	⊗	DEVIATION LO_LO	Value below configured monitoring limit
E052	⚠	DEVIATION LO	Value below configured monitoring limit
E053	⚠	DEVIATION HI	Value above configured monitoring limit
E054	⊗	DEVIATION HI_HI	Value above configured monitoring limit
E055	⊗	Remaining Capacity Range	The remaining capacity of the ion exchanger cannot be calculated.
E056	⊗	Degassed Conductivity	Min/max device limits exceeded: - Check both conductivity values.
E057	↔	Ion Exchanger Remaining Capacity	Remaining capacity of the ion exchanger < 20 %: Check ion exchanger; as required, replace the filter or the ion exchanger.
	⊗		Remaining capacity of the ion exchanger 0 %: Replace the ion exchanger. Replacement of the ion exchanger must be confirmed in the Maintenance menu: Maintenance ▶ [CI] [CII] Cond-Cond Calculation
E060	⊗	pH Range	pH range outside the permitted range of the VGB guideline: - Check both conductivity values. - Check choice of alkalizing agent. - Check ion exchanger. - Check both sensors/cables.
E061	⊗	pH LO_LO	Value below configured monitoring limit
E062	⚠	pH LO	Value below configured monitoring limit
E063	⚠	pH HI	Value above configured monitoring limit
E064	⊗	pH HI_HI	Value above configured monitoring limit
E200	↔	Param. Calculation Block	Check the configuration: Parameter Setting ▶ System Control ▶ Calculation Blocks























Conductivity (Inductive)

Error No.	Type	Message Text	Notes/Solution
T001		Configuration Data Loss	Data error in the configuration: Fully reconfigure the device.
T008		Adjustment Data	Error in the adjustment data: Switch device off (approx. 10 s). If the message persists, send in the device.
T009		Firmware Error	Error in the firmware: Switch device off (approx. 10 s). Reload the firmware. → <i>Firmware Update (FW-E106)</i> , p. 252 If the message persists, send in the device.
T010		Conductivity Range	Measuring range exceeded. Possible causes: Sensor not/incorrectly connected, cable incorrectly connected/faulty, range incorrectly specified, incorrect cell factor set. Parameter Setting ▶ [!] Analog CondI ▶ Sensor Data
T011		Conductivity LO_LO	Value below configured monitoring limit
T012		Conductivity LO	Value below configured monitoring limit
T013		Conductivity HI	Value above configured monitoring limit
T014		Conductivity HI_HI	Value above configured monitoring limit
T015		Temperature Range	Measuring range exceeded. Possible causes: Sensor not/incorrectly connected, cable incorrectly connected/faulty, range incorrectly specified, incorrect temperature probe selected. Parameter Setting ▶ [!] Analog CondI ▶ Sensor Data
T016		Temperature LO_LO	Value below configured monitoring limit
T017		Temperature LO	Value below configured monitoring limit
T018		Temperature HI	Value above configured monitoring limit
T019		Temperature HI_HI	Value above configured monitoring limit
T020		Resistivity Range	Measuring range exceeded. Possible causes: Sensor not/incorrectly connected, cable incorrectly connected/faulty, range incorrectly specified, incorrect cell factor set. Parameter Setting ▶ [!] Analog CondI ▶ Sensor Data
T021		Resistivity LO_LO	Value below configured monitoring limit
T022		Resistivity LO	Value below configured monitoring limit
T023		Resistivity HI	Value above configured monitoring limit
T024		Resistivity HI_HI	Value above configured monitoring limit
T025		Concentration Range	Measuring range exceeded. Possible causes: Sensor not/incorrectly connected, cable incorrectly connected/faulty, range incorrectly specified, incorrect cell factor set. Parameter Setting ▶ [!] Analog CondI ▶ Sensor Data
T026		Concentration LO_LO	Value below configured monitoring limit
T027		Concentration LO	Value below configured monitoring limit
T028		Concentration HI	Value above configured monitoring limit
T029		Concentration HI_HI	Value above configured monitoring limit

Error No.	Type	Message Text	Notes/Solution
T040		Salinity Range	Measuring range exceeded. Possible causes: Sensor not/incorrectly connected, cable incorrectly connected/faulty, range incorrectly specified, incorrect cell factor set. Parameter Setting ▶ [!] Analog Condl ▶ Sensor Data
T041		Salinity LO_LO	Value below configured monitoring limit
T042		Salinity LO	Value below configured monitoring limit
T043		Salinity HI	Value above configured monitoring limit
T044		Salinity HI_HI	Value above configured monitoring limit
T045		Conductance Range	Measuring range exceeded. Possible causes: Sensor not/incorrectly connected, incorrect sensor for range, cable faulty (short circuit).
T060		Sad Sensoface  Primary Coil	Sensor faulty: Replace sensor.
T061		Sad Sensoface  Secondary Coil	Sensor faulty: Replace sensor.
T063		Sad Sensoface  Zero Point	Adjust the sensor zero point.
T064		Sad Sensoface  Cell Factor	Incorrect cell factor set, incorrect adjustment: Repeat calibration/adjustment. Replace the sensor as required.
T070		TDS Range	Measuring range exceeded. Possible causes: Sensor not/incorrectly connected, cable incorrectly connected/faulty, range incorrectly specified, incorrect cell factor set. Parameter Setting ▶ [!] Analog Condl ▶ Sensor Data
T071		TDS LO_LO	Value below configured monitoring limit
T072		TDS LO	Value below configured monitoring limit
T073		TDS HI	Value above configured monitoring limit
T074		TDS HI_HI	Value above configured monitoring limit
T090	par	USP Limit	Configured USP limit was exceeded.
T091	par	Reduced USP Limit	The configured reduced USP limit was exceeded.
T110		CIP Counter	Configured number of CIP cycles exceeded: As required, calibrate/adjust sensor or replace.
T111		SIP Counter	Configured number of SIP cycles exceeded: As required, calibrate/adjust sensor or replace.
T113		Sensor Operating Time	Sensor operating time exceeded: Replace sensor.
T123		New Sensor, Adjustment Required	A new digital sensor was connected. It must now be adjusted:
T205	Info	Cal: Sensor Unstable	The drift criterion was not adhered to during calibration. Possible causes: improper calibration, sensor cable/connection faulty, sensor worn. Check the sensor and calibration and repeat as required. Otherwise, replace the sensor.

Oxygen

Error No.	Type	Message Text	Notes/Solution
D001	⊗	Configuration Data Loss	Data error in the configuration: Fully reconfigure the device.
D008	⊗	Adjustment Data	Error in the adjustment data: Switch device off (approx. 10 s). If the message persists, send in the device.
D009	⊗	Firmware Error	Error in the firmware: Switch device off (approx. 10 s). Reload the firmware. → <i>Firmware Update (FW-E106)</i> , p. 252 If the message persists, send in the device.
D010	⊗	Saturation %Air Range	Max/min limits of range exceeded or sensor not/incorrectly connected, cable faulty.
D011	⊗	Saturation %Air LO_LO	Value below configured monitoring limit
D012	⚠	Saturation %Air LO	Value below configured monitoring limit
D013	⚠	Saturation %Air HI	Value above configured monitoring limit
D014	⊗	Saturation %Air HI_HI	Value above configured monitoring limit
D015	⊗	Temperature Range	Max/min limits of range exceeded or sensor not/incorrectly connected, cable faulty.
D016	⊗	Temperature LO_LO	Value below configured monitoring limit
D017	⚠	Temperature LO	Value below configured monitoring limit
D018	⚠	Temperature HI	Value above configured monitoring limit
D019	⊗	Temperature HI_HI	Value above configured monitoring limit
D020	⊗	Concentration Range	Max/min limits of range exceeded, sensor not/incorrectly connected, cable faulty.
D021	⊗	Concentration LO_LO	Value below configured monitoring limit
D022	⚠	Concentration LO	Value below configured monitoring limit
D023	⚠	Concentration HI	Value above configured monitoring limit
D024	⊗	Concentration HI_HI	Value above configured monitoring limit
D025	⊗	Partial Pressure Range	Max/min limits of range exceeded, sensor not/incorrectly connected, cable faulty.
D026	⊗	Part. Pressure LO_LO	Value below configured monitoring limit
D027	⚠	Part. Pressure LO	Value below configured monitoring limit
D028	⚠	Part. Pressure HI	Value above configured monitoring limit
D029	⊗	Part. Pressure HI_HI	Value above configured monitoring limit
D040	⊗	Process Pressure Range	Max/min limits of range exceeded, sensor not/incorrectly connected, cable faulty.
D041	⊗	Process Pressure LO_LO	Value below configured monitoring limit
D042	⚠	Process Pressure LO	Value below configured monitoring limit
D043	⚠	Process Pressure HI	Value above configured monitoring limit
D044	⊗	Process Pressure HI_HI	Value above configured monitoring limit
D045	⊗	Saturation %O2 Range	Max/min limits of range exceeded, sensor not/incorrectly connected, cable faulty.
D046	⊗	Saturation %O2 LO_LO	Value below configured monitoring limit

Error No.	Type	Message Text	Notes/Solution
D047		Saturation %O2 LO	Value below configured monitoring limit
D048		Saturation %O2 HI	Value above configured monitoring limit
D049		Saturation %O2 HI_HI	Value above configured monitoring limit
D060		Sad Sensoface  Slope	- Readjust sensor. - Check/refill electrolyte. - SE740: Replace membrane body. - Replace sensor.
D061		Neutral Sensoface  Zero Point	- Readjust sensor. - Check/refill electrolyte. - SE740: Replace membrane body. - Replace sensor.
D062	par	Sad Sensoface  Sensochek	- Readjust configured sensor. - Replace sensor.
D063		Sad Sensoface  Response Time	- Check/refill electrolyte. - SE740: Replace membrane body. - Replace sensor.
D064		Sad Sensoface  Cal Timer	Calibration timer has expired: - Check the calibration timer settings. - Carry out calibration/adjustment.
P065	par	Sad Sensoface:  Leakage Current	Sensor faulty: Replace sensor.
D070	par	Sad Sensoface  Wear	Sensor is worn (100 %): - Readjust sensor. - Check/refill electrolyte. - Replace sensor.
D071	par	Sad Sensoface  Membrane	For SE740 optical oxygen sensor only: Replace membrane body.
D073	par	Sad Sensoface:  DLI	ISM sensor worn: Replace sensor.
D080		Sensor Current Range	- Check polarization voltage: Parameter Setting ▶ [I] [II] ... Oxy ▶ Sensor Data - Refill electrolyte. - Recalibrate/readjust.
D081		O2 Measurement OFF (Temp)	For SE740 optical oxygen sensor only: The oxygen measurement was automatically stopped because the temperatures are too high. → CIP/SIP Counters, p. 101
D110		CIP Counter	Configured number of CIP cycles exceeded: As required, recalibrate/ readjust sensor or replace.
D111		SIP Counter	Configured number of SIP cycles exceeded: As required, recalibrate/ readjust sensor or replace.
D112		Autoclaving Counter	Configured number of autoclavings exceeded: As required, recalibrate/ readjust sensor or replace.
D113		Sensor Operating Time	Sensor operating time exceeded. Replace sensor.
D114		Membrane Body Replacement	Replacement of the membrane body required. Replacement of the membrane body must be confirmed in the Maintenance menu. → Channel I/II Maintenance Functions, p. 159
D115		Interior Body Replacement	Interior body replacement required. Replacement of the interior body must be confirmed in the Maintenance menu. → Channel I/II Maintenance Functions, p. 159

Error No.	Type	Message Text	Notes/Solution
D120	⊗	Wrong Sensor	If sensor check is active: An impermissible sensor is connected to the device. - Replace sensor. - Change the process variable.
D121	⊗	Sensor Error (Factory Settings)	The digital sensor indicates an error. The sensor no longer works properly. Replace sensor.
D122	⊕	Sensor Memory (Cal Data)	The digital sensor indicates an error. The calibration data are defective: Recalibrate/readjust sensor.
D201	⊕	Cal: Temperature	The calibration temperature is impermissible: Check the calibration temperature. Note the information in the Calibration chapter. → <i>Oxygen Process Variable Calibration/Adjustment, p. 146</i>
D205	Info	Cal: Sensor Unstable	The drift criterion was not adhered to during calibration. Possible causes: improper calibration, sensor cable/connection faulty, sensor worn. Check the sensor and calibration and repeat as required. Otherwise, replace the sensor.

Oxy/Oxy Calculation Block

Error No.	Type	Message Text	Notes/Solution
H001	⊗	Configuration Data Loss	Data error in the configuration: Fully reconfigure the device.
H010	⊗	Saturation %Air Diff Range	Saturation value difference. Max/min device limits exceeded: - Check both saturation values. - Check sensor/cable connections.
H011	⊗	Saturation %Air Diff LO_LO	Value below configured monitoring limit
H012	⚠	Saturation %Air Diff LO	Value below configured monitoring limit
H013	⚠	Saturation %Air Diff HI	Value above configured monitoring limit
H014	⊗	Saturation %Air Diff HI_HI	Value above configured monitoring limit
H015	⊗	Temperature Diff Range	Temperature value difference. Max/min device limits exceeded: - Check both temperature values. - Check sensor/cable connections.
H016	⊗	Temperature Diff LO_LO	Value below configured monitoring limit
H017	⚠	Temperature Diff LO	Value below configured monitoring limit
H018	⚠	Temperature Diff HI	Value above configured monitoring limit
H019	⊗	Temperature Diff HI_HI	Value above configured monitoring limit
H020	⊗	Conc. (Liquid) Diff Range	Concentration value difference. Max/min device limits exceeded: - Check both concentration values. - Check sensor/cable connections.
H021	⊗	Conc. (Liquid) Diff LO_LO	Value below configured monitoring limit
H022	⚠	Conc. (Liquid) Diff LO	Value below configured monitoring limit
H023	⚠	Conc. (Liquid) Diff HI	Value above configured monitoring limit
H024	⊗	Conc. (Liquid) Diff HI_HI	Value above configured monitoring limit
H045	⊗	Saturation %O2 Diff Range	Saturation value difference. Max/min device limits exceeded: - Check both saturation values. - Check sensor/cable connections.
H046	⊗	Saturation %O2 Diff LO_LO	Value below configured monitoring limit
H047	⚠	Saturation %O2 Diff LO	Value below configured monitoring limit
H048	⚠	Saturation %O2 Diff HI	Value above configured monitoring limit
H049	⊗	Saturation %O2 Diff HI_HI	Value above configured monitoring limit
H090	⊗	Conc. (Gas) Diff Range	Concentration value difference. Max/min device limits exceeded: - Check both concentration values. - Check sensor/cable connections.
H091	⊗	Conc. (Gas) Diff LO_LO	Value below configured monitoring limit
H092	⚠	Conc. (Gas) Diff LO	Value below configured monitoring limit
H093	⚠	Conc. (Gas) Diff HI	Value above configured monitoring limit
H094	⊗	Conc. (Gas) Diff HI_HI	Value above configured monitoring limit
H200	↔	Param. Calculation Block	Check the configuration: Parameter Setting ▶ System Control ▶ Calculation Blocks

10.3 Sensocheck and Sensoface

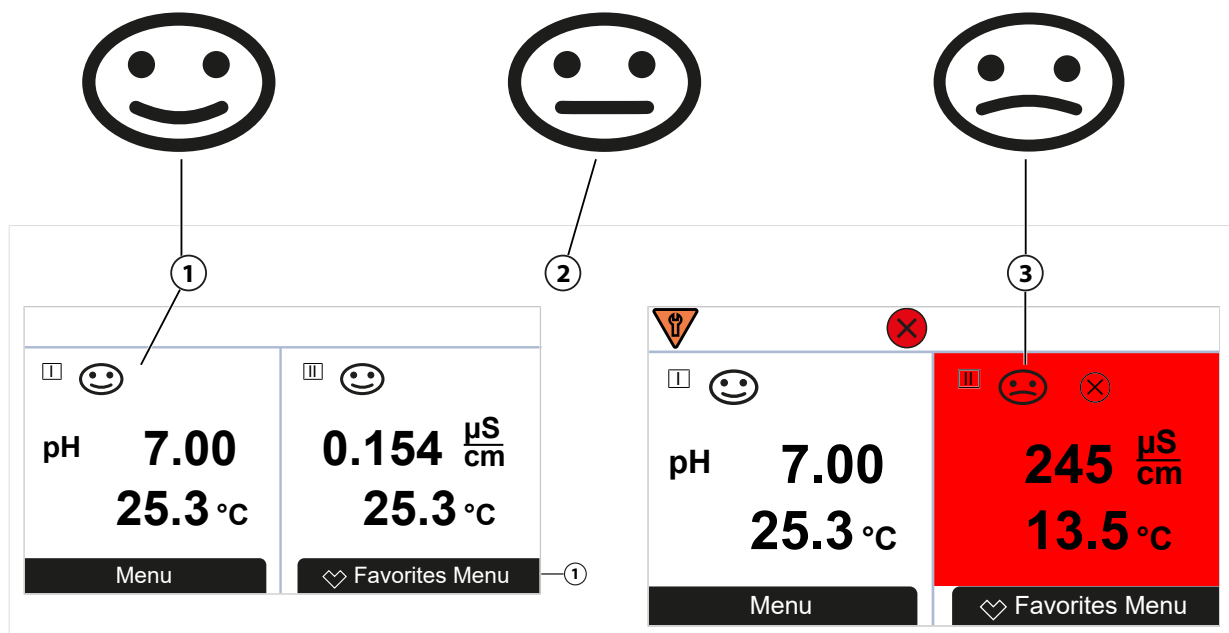

1 Happy Sensoface

2 Neutral Sensoface

The Sensoface icons provide the user with diagnostic information on wear and required maintenance of the sensor. In measuring mode, an icon (happy, neutral, or sad smiley) is shown on the display to reflect the continuous monitoring of the sensor parameters.

You can configure the current outputs so that a Sensoface message generates a 22-mA error signal:

[Parameter Setting](#) ▶ [Inputs/Outputs](#) ▶ [Current Outputs](#) ▶ [Current Output I...](#) ▶ [Behavior During Messages](#)

The Sensoface message can also be output via a relay contact:

[Parameter Setting](#) ▶ [Inputs/Outputs](#) ▶ [Relay Contacts](#) ▶ [Contact K...](#) → *Usage: Sensoface, p. 64*

Enabling/Disabling Sensoface

Sensoface is enabled and disabled in the [Sensor Data](#) submenu:

[Parameter Setting](#) ▶ [\[I\] \[II\] \[Sensor\]](#) ▶ [Sensor Data](#)

Note: After a calibration, a smiley is always displayed for confirmation, even if Sensoface is disabled.



Sensoface messages can be assigned to a relay contact:

[Parameter Setting](#) ▶ [Inputs/Outputs](#) ▶ [Relay Contacts](#) ▶ [Contact K...](#) ▶ [Usage](#)



If you select [Sensoface](#), all Sensoface messages are output via the selected contact.

If you select [Sensoface \(Channel\)](#), you can output the Sensoface messages from a specific channel via the selected contact.



Sensoface Criteria**pH**

Sensoface	Slope	Zero Point ¹⁾
 Happy	53.3 ... 61 mV/pH	pH 6 ... 8
 Sad	< 53.3 mV/pH or > 61 mV/pH	< pH 6 or > pH 8



Conductivity (Contacting)



Sensoface	Cell Constant	
	Analog Sensors	Memosens
 Happy	0.005 cm ⁻¹ ... 19.9999 cm ⁻¹	0.5x nom. cell constant ... 2x nom. cell constant
 Sad	< 0.005 cm ⁻¹ or > 19.9999 cm ⁻¹	< 0.5x nom. cell constant or > 2x nom. cell constant

Conductivity (Inductive)

Sensoface	Cell Factor		Zero Point
	Analog Sensors	Memosens	
 Happy	0.1 cm ⁻¹ ... 19.9999 cm ⁻¹	0.5x nom. cell factor ... 2x nom. cell factor	-0.25 mS ... 0.25 mS
 Sad	< 0.1 cm ⁻¹ or > 19.9999 cm ⁻¹	< 0.5 x nom. cell factor or > 2 x nom. cell factor	< -0.25 mS or > 0.25 mS

Oxygen

Sensoface	Slope		
	Standard Sensor (SE7*6)	Trace Sensor 01 (SE7*7 ...)	Trace Sensor 001
 Happy	-110 nA ... -30 nA	-525 nA ... -225 nA	-8000 nA ... -2500 nA
 Sad	< -110 nA or > -30 nA	< -525 nA or > -225 nA	< -8000 nA or > -2500 nA

Sensoface	Zero Point		
	Standard Sensor (SE7*6)	Trace Sensor 01 (SE7*7 ...)	Trace Sensor 001
 Happy	-1 nA ... 1 nA	-1 nA ... 1 nA	-3 nA ... 3 nA
 Sad	< -1 nA or > 1 nA	< -1 nA or > 1 nA	< -3 nA or > 3 nA

Note: The worsening of a Sensoface criterion leads to the devaluation of the Sensoface indicator (Smiley gets "sad"). An improvement of the Sensoface indicator can only take place after calibration or removal of the sensor defect.

¹⁾ Applies to standard sensors with zero point pH 7

Sensocheck

Process Variable	Sensocheck Function
pH:	Automatic monitoring of glass and reference electrode
Oxygen:	Monitoring membrane/electrolyte
Conductivity:	Information on sensor condition

Enable/Disable Sensocheck

Sensocheck is enabled and disabled in the **Sensor Data** submenu:

With Memosens:

Parameter Setting ▶ **[I] [II] Memosens ...** ▶ **Sensor Data** ▶ **Sensor Monitoring Details** ▶ **Sensocheck**

You can enable or disable Sensocheck in the **Monitoring** menu item.

In the **Message** menu item, select whether a Sensocheck message is output as a Failure or Maintenance Required message.

With analog sensors:

Parameter Setting ▶ **[I] [II] [Sensor]** ▶ **Sensor Data** ▶ **Sensocheck**

In the **Sensocheck** menu item, you can disable Sensocheck or choose to output a Sensocheck message as a Failure or Maintenance Required message.

11 Decommissioning

11.1 Disposal

The local codes and regulations must be observed when disposing of the product.

Customers can return their waste electrical and electronic devices.

Details on the return and environmentally friendly disposal of electrical and electronic equipment can be found in the manufacturer's declaration on our website. If you have any queries, suggestions, or questions regarding the recycling of waste electrical and electronic equipment from Knick, please send an email to → support@knick.de

11.2 Returns

If required, send the product in a clean condition and securely packed to your local contact.

→ knick.de

12 Accessories

Mounting accessories → *Dimension Drawings, p. 20*

12.1 Memory Card

Memory cards are used to save data or make firmware changes in conjunction with the Stratos Multi E461N. The device's measurement data, configuration data, and firmware can be saved.

Settings can be changed in **System Control** :

Menu Selection ▶ **Parameter Setting** ▶ **System Control** ▶ **Memory Card**

Inserting/Removing the Memory Card

⚠ WARNING! Shock potential. When opening the device, there may be dangerous touch voltages in the terminal compartment. Professional installation guarantees direct contact protection. The memory card can be replaced during operation. When doing so, maintain sufficient distance from the mains connection cables and do not use tools.

01. Deactivate any Data Card currently in use; see below.
02. Loosen the 4 screws on the front.
03. Open the front unit.
04. Take the memory card out of its packaging.
05. Insert the memory card with the connections at the front into the memory card slot on the front unit.

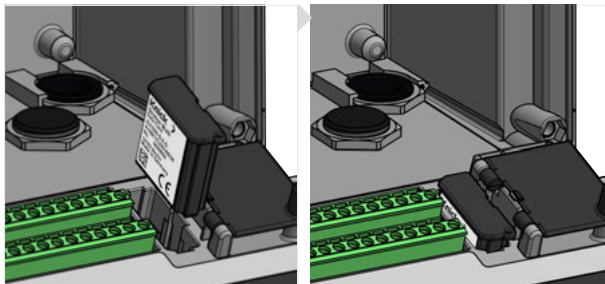

06. Close the housing and successively tighten the enclosure screws in a diagonal pattern.
 - ✓ The display shows an icon indicating the memory card type.

Deactivating the Data Card

Note: When using a Data Card: Before disconnecting the supply voltage and before removing, the memory card must be deactivated to prevent data being exposed to potential loss.

01. Open the **Maintenance** menu.
02. **Open/Close Memory Card** :
03. Terminate access to the memory card using the **right softkey: Close**.
 - ✓ The Data Card icon on the display is marked with an [x] .
04. Remove the memory card; see above.

Reactivating the Data Card

If the Data Card is not removed after being deactivated, the Data Card icon on the display remains marked with an [x]. The Data Card must be reactivated for further use:

01. Open the **Maintenance** menu.
02. **Open/Close Memory Card** :
03. Reactivate the memory card using the **right softkey: Open**.
 - ✓ The Data Card icon reappears on the display and the memory card can be used again.





Note: If using a different memory card, e.g., an FW Update Card, these steps can be omitted.

Connection to PC

Connect the memory card to the computer via a micro USB cable.



Memory Card Types and Icons

Symbol	Card type (original accessory)	Purpose
	Data Card ZU1080-S-N-D	Data recording (e.g., configuration, parameter sets, logbook, measurement recorder data). The icon flashes to indicate active data transmission. The Data Card can be used in combination with the following TAN options: FW-E102 Parameter Sets 1-5 FW-E103 Measurement Recorder FW-E104 Logbook
	FW Update Card ZU1080-S-N-U	Firmware update to expand functionality (TAN option FW-E106). In this case, the previous firmware is replaced by a new version. General data cannot be stored on this memory card.
	FW Repair Card ZU1080-S-N-R	Free firmware repair in the event of device errors. The TAN option FW-E106 is not required here. General data cannot be stored on this memory card.
	Custom FW Update Card ZU1080-S-N-S	Customer-specific FW versions Firmware update to expand functionality (TAN option FW-E106). A Custom FW Update Card can also be used to save older versions of the firmware. General data cannot be stored on this memory card.
	Custom FW Repair Card ZU1080-S-N-V	Customer-specific FW repair versions When using custom cards, the firmware version can be selected, e.g., in order to standardize the firmware of all available devices to a version that has been proven in use.

Firmware Update with FW Update Card

A firmware update with FW Update Card requires TAN option FW-E106.

→ *Firmware Update (FW-E106)*, p. 252

Firmware Repair with FW Update Card

Note: The firmware update add-on function need not be active for troubleshooting with the FW Repair Card.

01. Open the housing.
02. Insert the FW Repair Card into the memory card slot in the front unit.
03. Close the housing.
04. The automatic update process starts.

12.2 ZU1072 RJ45 Socket

Intended Use

The RJ45 socket makes it possible to connect a PROFINET cable to the Stratos Multi E461N. It is screwed into the bottom side of the housing, replacing one of the cable glands.

Sectional View

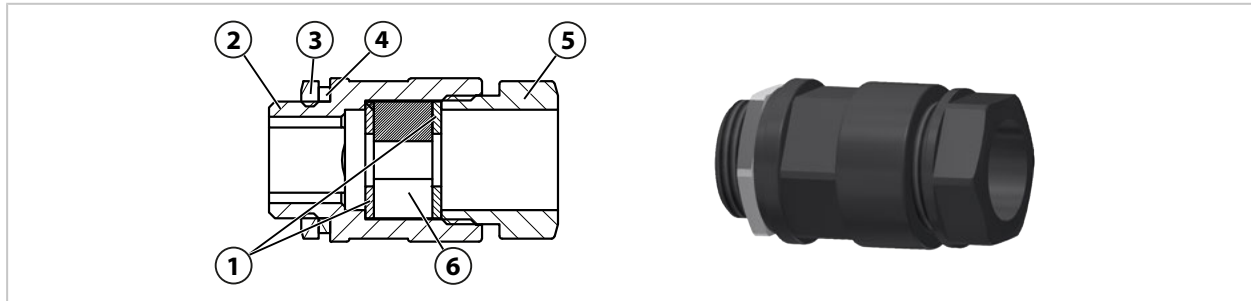

1 Washer	4 Connection thread gasket EADR 20
2 Housing	5 Pressure piece
3 Locknut EMMU 20	6 Split sealing insert GFD 25-01-065

Specifications

Materials	
Housing, pressure piece	PA6.6 – GF30 sw
Washer	POM, natural
Connection thread gasket EADR 20	EPDM, M20
Split sealing insert GFD 25-01-065	EPDM
Locknut EMMU 20	Brass, nickel-plated, M20
Min. cable diameter	4 mm
Max. cable diameter	6.5 mm
Number of cables	1
Max. connector dimensions (W x H)	15 mm x 11.2 mm
Color	Black
Dimensions	28 mm x 28 mm x 49.5 mm
Weight	Approx. 26 g
Ambient temperature	-20 ... 55 °C / -4 ... 131 °F
Degree of protection	IP67

Typical Applications

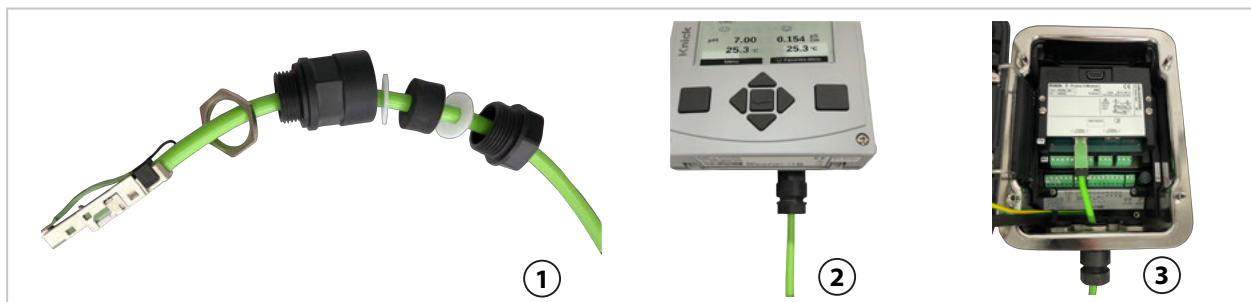

1 Socket with cable	3 Socket on Protos II with PN4400-095
2 Socket on Stratos Multi	

12.3 ZU1073 Adapter Cable RJ45/M12 D-Type

Intended Use

The adapter cable connects an RJ45 socket on the Stratos Multi E461N to a D-coded M12 socket and is used for Ethernet data transmission.

Connection Diagram

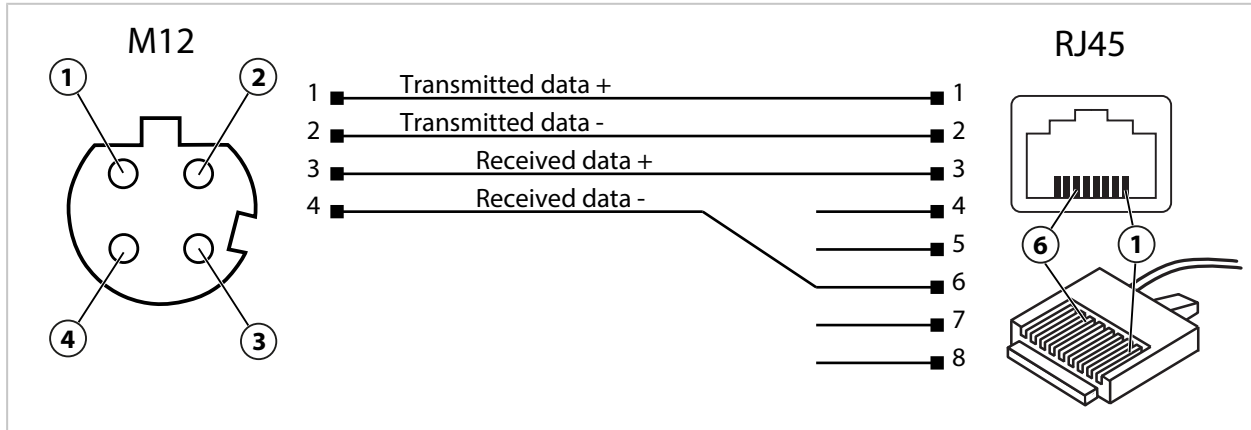

Specifications

Category	CAT 5
Material	PUR, polyolefin
Cable diameter	6.7 mm
Length	0.3 m
Ambient temperature	-20 ... 55 °C / -4 ... 131 °F
Protection	IP67

Typical Applications

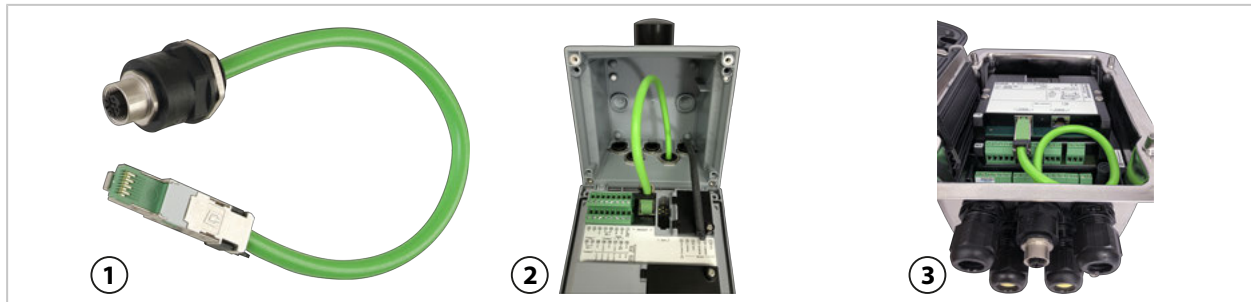

1 Adapter cable RJ45/M12 D-type
2 Stratos Multi

3 Protos II 4400 with PN4400-095

13 Specifications

13.1 Power

Power supply, terminals 17, 18	80 V (- 15 %) ... 230 (+ 10 %) V AC; approx. 15 VA; 45 ... 65 Hz 24 V (- 15 %) ... 60 (+ 10 %) V DC; 10 W
	Overvoltage category II, protection class II, pollution degree 2
Test voltage	Type test 3 kV AC 1 min after moisture pre-treatment Routine test 1.4 kV for 2 s

13.2 Inputs and Outputs (SELV, PELV)

Sensor input 1	for Memosens/optical sensors (SE740), galvanically isolated
Data in/out	Asynchronous interface, RS-485, 9600/19200 Bd
Power supply	3.08 V (3.02 ... 3.22 V)/10 mA, $R_i < 1 \Omega$, short-circuit-proof
Sensor input 2	For measuring module or analog/ISM ¹⁾ measuring module, galvanically isolated
Data in/out	Asynchronous interface RS-485, 9600 Bd
Power supply	3.08 V (3.02 ... 3.22 V)/6 mA, $R_i < 1 \Omega$, short-circuit-proof
Input OK1	Galvanically isolated (optocoupler) Switching between parameter sets A/B, flow measurement, function check
Parameter set selection	Relay input 0 ... 2 V (AC/DC) parameter set A Relay input 10 ... 30 V (AC/DC) parameter set B Control current 5 mA
Flow	Pulse input for flow measurement 0 ... 100 pulses per second Display: 00.0 ... 99.9 l/h Message via 22 mA or relay contact
Power out	Power output, short-circuit-proof, 0.5 W, for operating the SE740 sensor Off; 3.1 V (2.99 ... 3.25 V); 14 V (12.0 ... 16.0 V); 24 V (23.5 ... 24.9 V)
Output 1, 2 Out 1, Out 2	0/4 ... 20 mA, floating, load resistance up to 500 Ω , galvanically connected When using the current outputs, neither PROFINET nor the relay contacts can be used.
Failure message	3.6 mA or 22 mA, adjustable
Active	Max. 11 V
Passive	Supply voltage 3 ... 24 V
Process variable	Selection from all available process variables
Start/end of scale	Configurable within selected range
Characteristic	Linear, bi-/trilinear, or logarithmic
Output filter	PT1 filter, filter time constant 0 ... 120 s
Measurement error ²⁾	< 0.25 % of current value + 0.025 mA
Contact REL1, REL2	Relay contact, floating
Contact rating with ohmic load	AC < 30 V _{rms} / < 15 VA DC < 30 V / < 15 W
Max. switching current	3 A, max. 25 ms
Max. continuous current	500 mA
User-definable: Failure, maintenance required, function check, min/max limit, rinse contact, parameter set B signaling, USP output, Sensoface	

¹⁾ ISM with TAN option FW-E053

²⁾ At rated operating conditions

Alarm contact	
Contact response	N/C (fail-safe type)
Response delay	0000 ... 0600 s
Rinse contact	
To control a simple cleaning system	
Contact rating with ohmic load	AC < 30 V _{rms} / < 15 VA DC < 30 V / < 15 W
Max. switching current	3 A, max. 25 ms
Max. continuous current	500 mA
Contact response	N/C or N/O
Interval	000.0 ... 999.9 h (000.0 h = cleaning function disabled)
Cleaning time/relax time	0000 ... 1999 s
Min/max limits	
Min/max contacts, floating, interconnected	
Contact response	N/C or N/O
Response delay	0000 ... 9999 s
Setpoints	Within selected range
Hysteresis	User-defined
Service functions in the Maintenance menu	
Sensor monitor	Direct display of measured values from sensor (mV, temperature, resistance, ...)
Current source ¹⁾	Current specifiable for output 1 and 2 (00.00 ... 22.00 mA)
Relay test ²⁾	Manual control of relay contacts

13.3 Device

Product name	Stratos Multi
Product type	E461N
Measurements	pH ORP Amperometric oxygen/optical oxygen Contacting/inductive conductivity Dual conductivity
2 parameter sets	Parameter set A and B
Select via digital control input OK1 or manually	
Memory card	Accessory for additional functions (firmware update, measurement records, logbook)
Memory size	32 MB
Logbook	For exclusive use: min. 20,000 entries
Measurement recorder	For exclusive use: min. 20,000 entries
Computer ports	Micro USB
Connection to device	Plug
Communication	USB 2.0, high-speed, 12 Mbit/s Data Card, MSD (Mass Storage Device) FW Update Card, FW Repair Card: HID (human interface device)
Dimensions	L 32 mm x W 12 mm x H 30 mm
Display	Graphical TFT color display, 4.3", white backlighting
Resolution	480 x 272 pixels

¹⁾ Not if PROFINET communication is enabled

²⁾ Only if PROFINET communication is enabled

Language	German, English, French, Spanish, Italian, Portuguese, Chinese, Korean, Swedish
Sensoface	Sensor status display: Happy, neutral, sad smileys
Status indicators	Icons for parameter setting and messages
Keypad	Softkey 1 left, softkey 2 right, arrow keys (cursor), enter
Door contact	When door is open: electric signal and logbook entry, error message F039 "Door Open"
Real-time clock	Different time and date formats selectable, power reserve approx. 1 day
Housing	
Molded enclosure	Glass fiber reinforced Front unit material: PBT Rear unit material: PC
Protection	IP66/IP67/TYP E 4X outdoor (with pressure compensation) when the device is closed
Flammability	UL 94 V-0 for external parts
Weight	1.2 kg (1.6 kg incl. accessories and packaging)
Mounting	Wall, pipe/post or panel mounting
Color	Gray RAL 7001
Dimensions	H 148 mm, W 148 mm, D 117 mm
Control panel cutout	138 mm x 138 mm acc. to DIN 43 700
Cable glands	
5 knockouts for M20 x 1.5 cable glands	
2 of 5 knockouts for NPT ½" or rigid metallic conduit	
Terminals	
Screw terminals	For single and stranded wires 0.2 ... 2.5 mm ²
Tightening torque	0.5 ... 0.6 Nm
Wiring	
Stripping length	Max. 7 mm
Temperature resistance	> 75 °C / 167 °F

13.4 Rated Operating Conditions

Climatic class	3K5 according to EN 60721-3-3
Location class	C1 according to EN 60654-1
Ambient temperature	-20 ... 60 °C / -4 ... 140 °F
Altitude of installation site	Max. 60 V DC power supply at altitudes above 2000 m (AMSL)
Relative humidity	5 ... 95 %

13.5 Transport and Storage

Transport/storage temperature	-30 ... 70 °C / -22 ... 158 °F
-------------------------------	--------------------------------

13.6 Conformity

EMC	EN 61326-1, NAMUR NE 21
Emitted interference	Class A (industrial applications) ¹⁾
Interference immunity	Industrial applications
RoHS conformity	According to EU directive 2011/65/EU
Electrical safety	According to EN 61010-1, Protection against electric shock by reinforced insulation of all extra-low-voltage circuits against mains

¹⁾ This equipment is not designed for domestic use, and is unable to guarantee adequate protection of the radio reception in such environments.

13.7 Communication Interfaces

Number of Ethernet interfaces	1x RJ45, expandable to 2 interfaces with ZU1166 adapter cable and ZU1164 Y cable
Device type	IO device
IO specification	V2.3
Conformance class	Class B
Network load class	2
Transfer rate	125 Mbit/s (electric 100BASE-TX)
Recommended cable	CAT 5, CAT 5e, CAT 6
Vendor ID	97 (= Knick)
Device ID	0x0003
Min. cycle times	1 ms
Identification & maintenance	I&M1-3, 0
Number of AIs	20
Number of AOs	1
Number of DOs	2

13.8 Measuring Functions

13.8.1 pH

Memosens input

Input for Memosens sensors (pH, ORP, pH/ORP)

Terminals 1 ... 5 or MK-MS095N module

Display ranges	Temperature: -20.0 ... 200.0 °C / -4 ... 392 °F
	pH value: -2.00 ... 16.00
	ORP: -1999 ... 1999 mV
	rH value (with pH/ORP sensor): 0 ... 42.5

Measurement error	Depending on sensor
-------------------	---------------------

Module input, analog or ISM ¹⁾

For pH and ORP sensors with MK-PH015N

Measuring ranges	Temperature: -20.0 ... 200.0 °C / -4 ... 392 °F
	pH value: -2.00 ... 16.00
	ORP: -1999 ... 1999 mV
	rH value (with pH/ORP sensor): 0 ... 42.5

Glass electrode input Reference temperature 25 °C/77 °F	Input resistance > 1 x 10 ¹² Ω
	Input current < 1 x 10 ⁻¹² A
	Impedance range: 0.5 ... 1000 MΩ (± 20 %)

Reference electrode input Reference temperature 25 °C/77 °F	Input resistance > 1 x 10 ¹⁰ Ω
	Input current < 1 x 10 ⁻¹⁰ A
	Impedance range: 0.5 ... 200 kΩ (± 20 %)

Measurement error ^{2) 3)}	pH value < 0.02, TC: 0.002 pH/K mV value < 1 mV, TC: 0.1 mV/K
------------------------------------	--

Temperature input via module

Pt100/Pt1000/NTC 30 kΩ/NTC 8.55 kΩ/Balco 3 kΩ

2-wire connection, adjustable

Measuring ranges	Pt100/Pt1000: -20.0 ... 200.0 °C / -4 ... 392 °F
	NTC 30 kΩ: -20.0 ... 150.0 °C / -4 ... 302 °F
	NTC 8.55 kΩ (Mitsubishi): -10.0 ... 130.0 °C / 14 ... 266 °F
	Balco 3 kΩ: -20.0 ... 130.0 °C / -4 ... 266 °F

Adjustment range	10 K
------------------	------

Resolution	0.1 °C / 0.1 °F
------------	-----------------

Measurement error ^{2) 3)}	< 0.5 K (< 1 K for Pt100; < 1 K for NTC > 100 °C/212 °F)
------------------------------------	--

Temperature compensation

Off

Linear characteristic 00.00 ... 19.99 %/K

Ultrapure water

Table: 0 ... 95 °C, user-defined in 5-K steps

Ref. temperature	25 °C / 77 °F
------------------	---------------

¹⁾ ISM with TAN option FW-E053

²⁾ At rated operating conditions

³⁾ ± 1 count, plus sensor error

pH calibration and adjustment

Calibration with automatic buffer recognition (Calimatic)

Manual calibration with entry of individual buffer values

Product calibration

Data entry of premeasured sensors

ISFET zero point (with ISFET sensors)

Temperature probe adjustment

Calculation of nominal zero point

Max. calibration range	Asymmetry potential (zero point): ± 60 mV Slope: 80 ... 103 % (47.5 ... 61 mV/pH)
------------------------	--

Zero adjustment	± 750 mV for Memosens ISFET
-----------------	---------------------------------

Buffer sets

Knick CaliMat	2.00/4.00/7.00/9.00/12.00
---------------	---------------------------

Mettler-Toledo	2.00/4.01/7.00/9.21
----------------	---------------------

Merck/Riedel	2.00/4.00/7.00/9.00/12.00
--------------	---------------------------

DIN 19267	1.09/4.65/6.79/9.23/12.75
-----------	---------------------------

NIST Standard	1.679/4.005/6.865/9.180
---------------	-------------------------

NIST technical	1.68/4.00/7.00/10.01/12.46
----------------	----------------------------

Hamilton	2.00/4.01/7.00/10.01/12.00
----------	----------------------------

Kraft	2.00/4.00/7.00/9.00/11.00
-------	---------------------------

Hamilton A	2.00/4.01/7.00/9.00/11.00
------------	---------------------------

Hamilton B	2.00/4.01/6.00/9.00/11.00
------------	---------------------------

HACH	4.01/7.00/10.01
------	-----------------

Ciba (94)	2.06/4.00/7.00/10.00
-----------	----------------------

WTW techn. buffers	2.00/4.01/7.00/10.00
--------------------	----------------------

Reagecon	2.00/4.00/7.00/9.00/12.00
----------	---------------------------

Specifiable buffer set	TAN Option FW-E002
------------------------	--------------------

ORP calibration and adjustment

ORP data entry

ORP adjustment

ORP check

Temperature probe adjustment

Max. calibration range	-700 ... 700 Δ mV
------------------------	--------------------------

Adaptive calibration timer

Interval	0000 ... 9999 h
----------	-----------------

13.8.2 Conductivity (Contacting)

Memosens input

Input for Memosens sensors

Terminals 1 ... 5 or MK-MS095N module

Measurement error Depending on sensor

Module input, analog

Input for analog 2- or 4-electrode sensors with MK-COND025N module

Measuring ranges
(Conductance limited to 3500 mS) 2-electrode sensors: 0.2 $\mu\text{S} \cdot \text{cm}$... 200 $\text{mS} \cdot \text{cm}$
4-electrode sensors: 0.2 $\mu\text{S} \cdot \text{cm}$... 1000 $\text{mS} \cdot \text{cm}$

Measurement error ^{1) 2)} < 1 % of measured value + 0.4 $\mu\text{S} \cdot \text{cm}$

Temperature input via module

Pt100/Pt1000/Ni100/NTC 30 k Ω /NTC 8.55 k Ω (Betatherm)

3-wire connection, adjustable

Measuring ranges Pt100/Pt1000: -50.0 ... 250.0 $^{\circ}\text{C}$ / -58 ... 482 $^{\circ}\text{F}$
Ni100: -50.0 ... 180.0 $^{\circ}\text{C}$ / -58 ... 356 $^{\circ}\text{F}$
NTC 30 k Ω : -20.0 ... 150.0 $^{\circ}\text{C}$ / -4 ... 302 $^{\circ}\text{F}$
NTC 8.55 k Ω : -10.0 ... 130.0 $^{\circ}\text{C}$ / 14 ... 266 $^{\circ}\text{F}$

Resolution 0.1 $^{\circ}\text{C}$ / 0.1 $^{\circ}\text{F}$

Measurement error ^{1) 2)} < 0.5 K (< 1 K for Pt100; < 1 K for NTC > 100 $^{\circ}\text{C}$ /212 $^{\circ}\text{F}$)

Display ranges

Conductivity 0.000 ... 9.999 $\mu\text{S}/\text{cm}$
00.00 ... 99.99 $\mu\text{S}/\text{cm}$
000.0 ... 999.9 $\mu\text{S}/\text{cm}$
0.000 ... 9.999 mS/cm
00.00 ... 9.99 mS/cm
000.0 ... 999.9 mS/cm
0.000 ... 9.999 S/m
00.00 ... 99.99 S/m

Resistivity 00.00 ... 99.99 $\text{M}\Omega \cdot \text{cm}$

Concentration 0.00 ... 99.99 %

Salinity 0.0 ... 45.0 ‰ (0 ... 35 $^{\circ}\text{C}$ / 32 ... 95 $^{\circ}\text{F}$)

TDS 0 ... 5000 mg/l (10 ... 40 $^{\circ}\text{C}$ / 50 ... 104 $^{\circ}\text{F}$)

Response time (T90) Approx. 1 s

USP function

Water monitoring in the pharmaceutical industry (USP<645>) with additionally specifiable limit (%)

Output via a relay contact

Calibration and adjustment

Automatic with standard calibration solution

Calibration by entry of cell constant

Product calibration

Temperature probe adjustment

Permissible cell constant 00.0050 ... 19.9999 cm^{-1}

¹⁾ At rated operating conditions

²⁾ ± 1 count, plus sensor error

13.8.3 Conductivity (Inductive)

Digital input

Input for Memosens or SE670/SE680K toroidal conductivity sensors

Terminals 1 ... 5 or MK-MS095N module

Measurement error Depending on sensor

Module input, analog

Input for SE655/656/660 toroidal conductivity sensors with MK-CONDI035N module

Measurement error ^{1) 2)} < 1 % of measured value + 0.005 mS/cm

Temperature input via module

Pt100/Pt1000/NTC 30 kΩ

3-wire connection, adjustable

Measuring ranges Pt100/Pt1000: -50.0 ... 250.0 °C / -58 ... 482 °F

NTC 30 kΩ: -20.0 ... 150.0 °C / -4 ... 302 °F

Resolution 0.1 °C / 0.1 °F

Measurement error ^{1) 2)} 0.5 K (< 1 K for Pt100; < 1 K for NTC > 100 °C/212 °F)

Display ranges

Conductivity 000.0 ... 999.9 μS/cm (not with SE660/SE670)

0.000 ... 9.999 mS/cm (not with SE660/SE670)

00.00 ... 99.99 mS/cm

000.0 ... 999.9 mS/cm

0000 ... 1999 mS/cm

0.000 ... 9.999 S/m

00.00 ... 99.99 S/m

Concentration 0.00 ... 9.99 % / 10.0 ... 100.0 %

Salinity 0.0 ... 45.0 ‰ (0 ... 35 °C / 32 ... 95 °F)

TDS 0 ... 5000 mg/l (10 ... 40 °C / 50 ... 104 °F)

Response time (T90) Approx. 1 s

USP Function

Water monitoring in the pharmaceutical industry (USP<645>) with additionally specifiable limit (%)

Output via a relay contact

Calibration and adjustment

Automatic with standard calibration solution

Calibration by input of cell factor

Product calibration

Installation factor

Zero correction

Temperature probe adjustment

Permissible cell factor 00.100 ... 19.999 cm⁻¹

Permissible transfer ratio 010.0 ... 199.9

Permissible offset ± 0.5 mS

Permissible installation factor 0.100 ... 5.000

¹⁾ At rated operating conditions

²⁾ ± 1 count, plus sensor error

13.8.4 Conductivity (Dual)

Memosens input

Input for Memosens sensors

Terminals 1 ... 5 and MK-MS095N module

Also possible: Memosens sensor and analog sensor via MK-COND025N module

→ *Conductivity (Contacting) Process Variable, p. 80*

Measurement error	Depending on sensor
-------------------	---------------------

MK-CC05N module input, analog

Input for two analog 2-electrode sensors

Measuring range	0 ... 30000 $\mu\text{S} \cdot \text{cm}$
-----------------	---

Measurement error ^{1) 2)}	< 1 % of measured value + 0.4 $\mu\text{S} \cdot \text{cm}$
------------------------------------	---

Connection length	Max. 3 m
-------------------	----------

Temperature input via module

Pt1000, 2-wire connection, adjustable

Measuring range	-50,0 ... 200,0 °C / -58 ... 392 °F
-----------------	-------------------------------------

Resolution	0.1 °C / 0.1 °F
------------	-----------------

Measurement error ^{1) 2)}	< 0.5 K (< 1 K at > 100 °C / 212 °F)
------------------------------------	--------------------------------------

Display ranges

Conductivity	0.000 ... 9.999 $\mu\text{S}/\text{cm}$
--------------	---

00.00 ... 99.99 $\mu\text{S}/\text{cm}$

000.0 ... 999.9 $\mu\text{S}/\text{cm}$

0000 ... 9999 $\mu\text{S}/\text{cm}$

Resistivity	00.00 ... 99.99 M Ω cm
-------------	-------------------------------

Response time (T90)	Approx. 1 s
---------------------	-------------

Calibration and adjustment

Automatic with standard calibration solution

Calibration by entry of cell constant

Product calibration

Temperature probe adjustment

Permissible cell constant	00.0050 ... 19.9999 cm^{-1}
---------------------------	--------------------------------------

¹⁾ At rated operating conditions

²⁾ ± 1 count, plus sensor error

13.8.5 Temperature Compensation (Conductivity)

Off	Without
Linear	Linear characteristic 00.00 ... 19.99 %/K Reference temperature adjustable Reference temperature 25 °C/77 °F:
NLF	Natural waters acc. to EN 27888
NaCl	NaCl from 0 (ultrapure water) to 26 wt% (0 ... 120 °C/32 ... 248 °F)
HCl	Ultrapure water with HCl traces (0 ... 120 °C/32 ... 248 °F)
NH ₃	Ultrapure water with NH ₃ traces (0 ... 120 °C/32 ... 248 °F)
NaOH	Ultrapure water with NaOH traces (0 ... 120 °C/32 ... 248 °F)

13.8.6 Concentration Determination, Conductivity (TAN Option FW-E009)

NaCl	0 ... 28 wt% (0 ... 100 °C/32 ... 212 °F)
HCl	0 ... 18 wt% (-20 ... 50 °C/-4 ... 122 °F) 22 ... 39 wt% (-20 ... 50 °C/-4 ... 122 °F)
NaOH	0 ... 24 wt% (0 ... 100 °C/32 ... 212 °F) The range limits apply to 25 °C/77 °F. 15 ... 50 wt% (0 ... 100 °C/32 ... 212 °F)
H ₂ SO ₄	0 ... 37 wt% (-17.8 ... 110 °C/-0.04 ... 230 °F) The range limits apply to 27 °C/80.6 °F. 28 ... 88 wt% (-17.8 ... 115.6 °C/-0.04 ... 240.08 °F) 89 ... 99 wt% (-17.8 ... 115.6 °C/-0.04 ... 240.08 °F)
HNO ₃	0 ... 30 wt% (-20 ... 50 °C/-4 ... 122 °F) 35 ... 96 wt% (-20 ... 50 °C/-4 ... 122 °F)
H ₂ SO ₄ ·SO ₃ (Oleum)	12 ... 45 wt% (0 ... 120 °C/32 ... 248 °F) Specifiable concentration table

13.8.7 Oxygen

Digital input, Memosens	
Standard measurement / with TAN option FW-E016: Trace measurement	Input for amperometric Memosens sensors: Terminals 1 ... 5 or MS095N module
Display range	Temperature: -20.0 ... 150.0 °C / -4 ... 302 °F
Measurement error	Depending on sensor
Digital input, SE 740	
Standard measurement / with TAN option FW-E016: Trace measurement	Input for SE 740 optical oxygen sensor: Terminals 1 ... 6
Measuring range	0 ... 300 % air saturation
Detection limit	0.01 vol%
Response time T98	< 30 s (at 25 °C/77 °F, from air to nitrogen)
Display range	Temperature: -10.0 ... 130.0 °C / 14 ... 266 °F The sensor does not supply any oxygen measured values above 80 °C/176 °F.
Measurement error	Depending on sensor
Module input, analog or ISM ¹⁾	
Standard	Sensors with MK-OXY046N module: SE706; InPro 6800; Oxyferm, ISM
Input range	Measuring current -600 ... 2 nA, resolution 10 pA
Measurement error ²⁾	< 0.5 % of measured value + 0.05 nA + 0.005 nA/K
Trace measurement TAN option FW-E016	Sensors with MK-OXY046N module: SE707; InPro 6900; Oxyferm/Oxygold
Input range I	Measuring current -600 ... 2 nA, resolution 10 pA Automatic range selection
Measurement error ²⁾	< 0.5 % of measured value + 0.05 nA + 0.005 nA/K
Input range II	Measuring current -10000 ... 2 nA, resolution 166 pA Automatic range selection
Measurement error ²⁾	< 0.5 % of measured value + 0.8 nA + 0.08 nA/K
Polarization voltage	-400 ... -1000 mV, preset -675 mV, resolution < 5 mV
Permissible guard current	≤ 20 μA
Temperature input via module	
NTC 22 kΩ/NTC 30 kΩ 2-wire connection, adjustable	
Measuring range	-20.0 ... 150.0 °C / -4 ... 302 °F
Adjustment range	10 K
Resolution	0.1 °C / 0.1 °F
Measurement error ^{2) 3)}	< 0,5 K (< 1 K at > 100 °C / > 212 °F)
Operating modes	
Measurement in gases	
Measurement in liquids	

¹⁾ ISM with TAN option FW-E053

²⁾ At rated operating conditions

³⁾ ± 1 count, plus sensor error

Measuring ranges

Standard sensor (Memosens, SE740, digital, analog)

Saturation ¹⁾	0.0 ... 600.0 %
Concentration ¹⁾ (dissolved oxygen)	0.00 ... 99.99 mg/l (ppm)
Volume concentration in gas	0.00 ... 99.99 vol%

Trace sensor "01" (Memosens, SE740, analog)

Saturation ¹⁾	0.000 ... 150.0 %
Concentration ¹⁾ (dissolved oxygen)	0000 ... 9999 µg/l / 10.00 ... 20.00 mg/l 0000 ... 9999 ppb/10.00 ... 20.00 ppm
Volume concentration in gas	000.0 ... 9999 ppm/1.000 ... 50.00 vol%

Trace sensor "001" (analog)

Saturation ¹⁾	0.000 ... 150.0 %
Concentration ¹⁾ (dissolved oxygen)	000.0 ... 9999 µg/l / 10.00 ... 20.00 mg/l 000.0 ... 9999 ppb/10.00 ... 20.00 ppm
Volume concentration in gas	000.0 ... 9999 ppm/1.000 ... 50.00 vol%

Input correction

Pressure correction	0000 ... 9999 mbar / 999.9 kPa / 145.0 psi (adjustable) Manual or external (via current input 0(4) ... 20 mA)
Salinity correction	0.0 ... 45.0 g/kg

Calibration and adjustment

Automatic calibration in air-saturated water

Automatic calibration in air

Product calibration, saturation (with offset on SE 740)

Zero correction

Temperature probe adjustment

Calibration ranges

Standard sensor

Zero point	± 2 nA
Slope	25 ... 130 nA (at 25 °C / 77 °F, 1013 mbar)

Trace sensor "01"

Zero point	± 2 nA
Slope	200 ... 550 nA (at 25 °C / 77 °F, 1013 mbar)

Trace sensor "001"

Zero point	± 3 nA
Slope	2000 ... 9000 nA (at 25 °C / 77 °F, 1013 mbar)

Calibration timer 0000 ... 9999 h¹⁾ For temperature range -10 ... 80 °C/14 ... 176 °F

13.9 Diagnostics and Statistics

Diagnostic functions	
Calibration data	Calibration record
Device self-test	Automatic memory test (RAM, FLASH, EEPROM)
Display test	Display of all colors
Keypad test	Check of key functions
Sensocheck	
Delay: approx. 30 s	
pH	Automatic monitoring of glass and reference electrode (can be switched off)
Cond	Polarization detection and monitoring of cable capacitance
Condl	Monitoring of primary and secondary coils and lines for open circuit and of primary coil and lines for short circuit
Oxygen	With amperometric sensors only Monitoring of membrane and electrolyte and the sensor wires for short circuits or open circuits (can be switched off)
Sensoface	
Provides information on the sensor condition (can be switched off; happy, neutral, sad smileys). Evaluation criteria → <i>Sensocheck and Sensoface</i> , p. 178	
pH	Evaluation of zero/slope, response, calibration interval, Sensocheck, wear
Cond	Evaluation of Sensocheck
Condl	Evaluation of zero point, cell factor, installation factor, Sensocheck
Oxygen	Evaluation of zero point/slope, response time, calibration interval, Sensocheck, and sensor wear for digital sensors
Sensor monitor	
Display of direct sensor measured values:	
pH	pH/voltage/temperature
Cond	Resistance/temperature
Condl	Resistance/temperature
Oxygen	Sensor current/temperature
Measurement recorder TAN option FW-E103 → <i>Measurement Recorder (FW-E103)</i> , p. 250	
4-channel measurement recorder with marking of events (failure, maintenance required, function check, limit values)	
Storage capacity	100 entries in device memory, at least 20,000 entries in conjunction with Data Card
Recording	Process variables and span freely adjustable
Type of recording	Current value
Time base	10 s ... 10 h
Logbook	
Recording of function activations, appearance and disappearance of warning and failure messages, with date and time, 100 entries with date and time in device memory, viewable on display	
TAN option FW-E104	At least 20,000 entries in conjunction with Data Card

14 Annex

14.1 Channel II Wiring Examples

14.1.1 pH Analog Wiring Examples

Example 1, pH Analog

Measuring task:	pH, temperature, glass impedance
Sensors (example):	SE 555X/1-NS8N
Cable (example):	ZU 0318

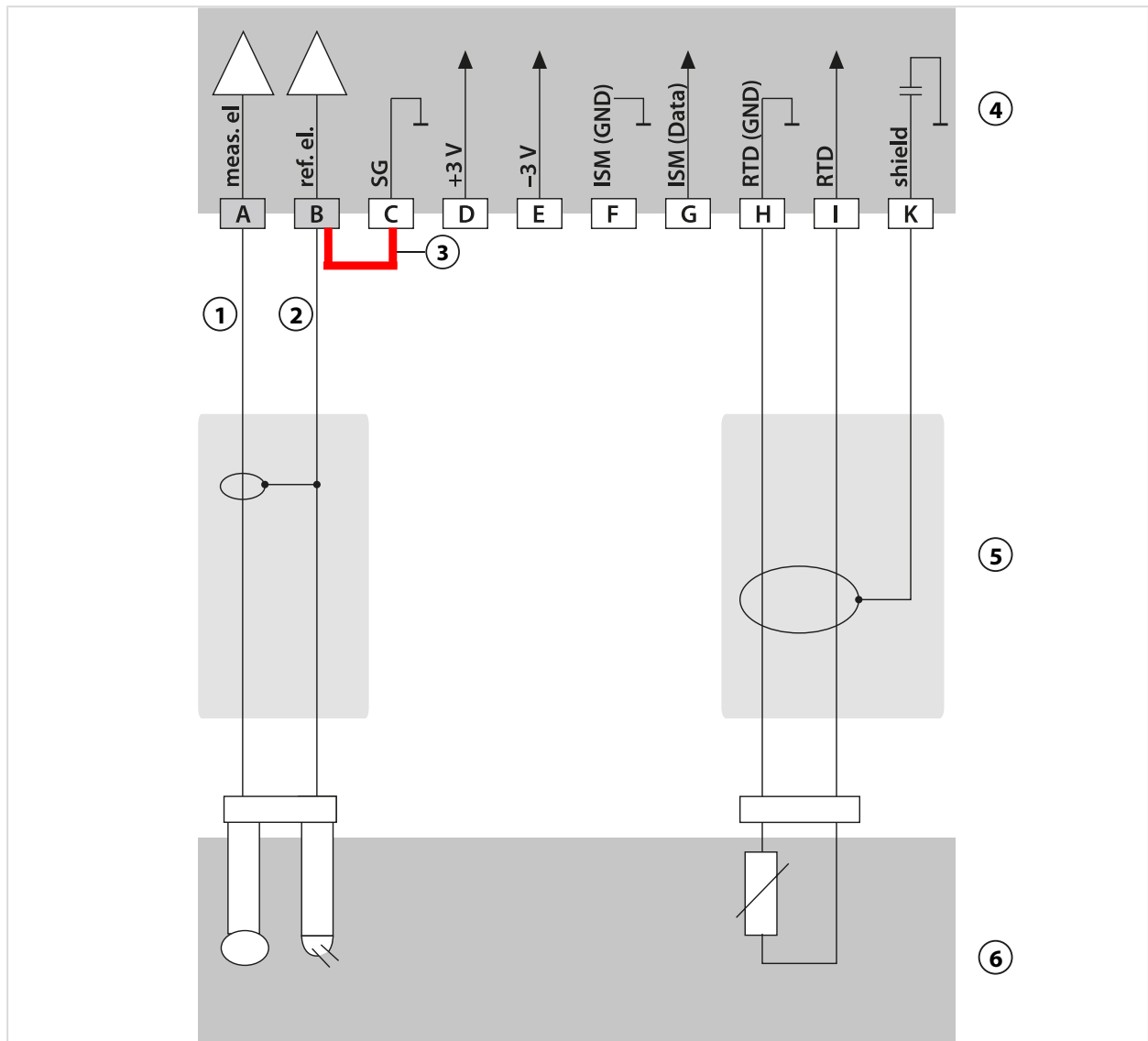

1 Core	4 pH module
2 Shield	5 Cables
3 Jumper!	6 Sensors

Example 2, pH Analog

Measuring task:	pH/ORP, temp., glass impedance, reference impedance
Sensors (example):	SE555X/1-NS8N, equipotential bonding: ZU0073 Temperature: e.g., Pt1000
Cable (example):	2x ZU0318

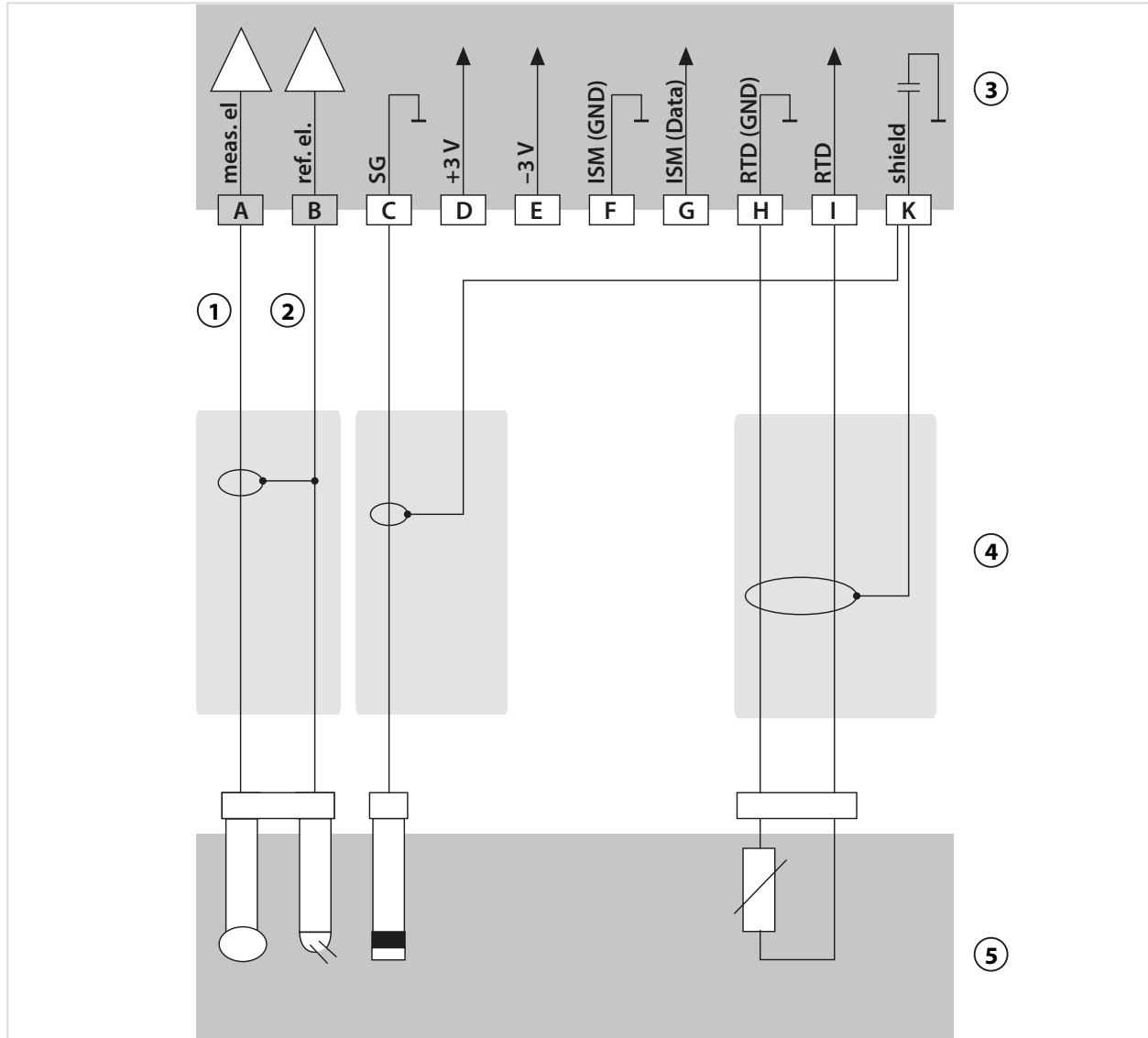

1 Core	4 Cables
2 Shield	5 Sensors
3 pH module	

Example 3, pH Analog

Measuring task:	pH, temp, glass impedance
Sensor:	pH sensor e.g., SE 554X/1-NVPN, cable CA/VP6ST-003A
Temperature detector:	Integrated

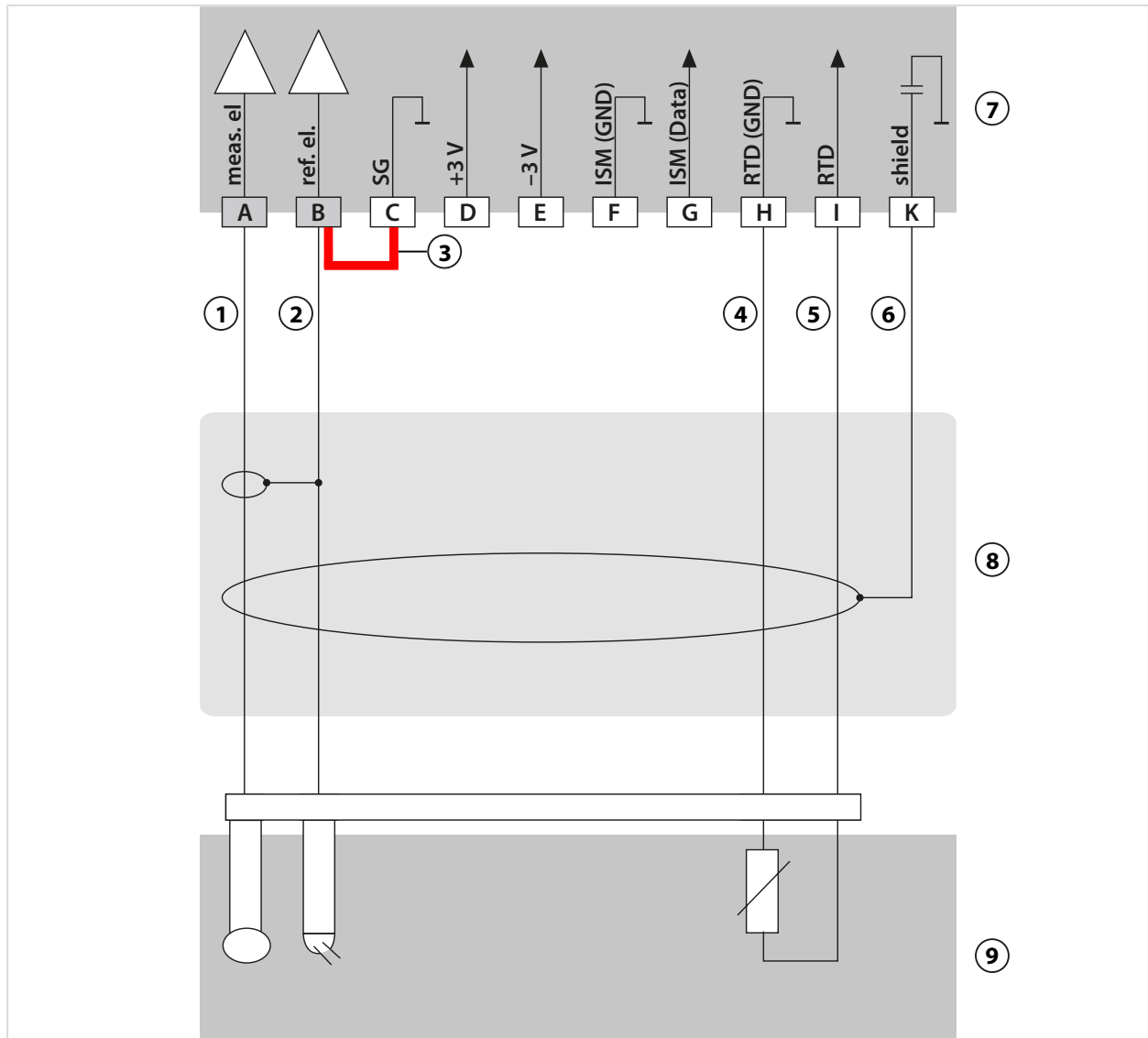

1 Core, clear	6 Shield, yellow/green
2 Shield, red	7 pH module
3 Jumper!	8 VP cable
4 Green	9 Sensor
5 White	

Example 4, pH Analog

Measuring task:	pH/ORP, temp., glass impedance, reference impedance
Sensors (example):	pH sensor, e.g., SE 555X/1-NVPN, cable CA/VP6ST-003A
Temperature detector:	Integrated

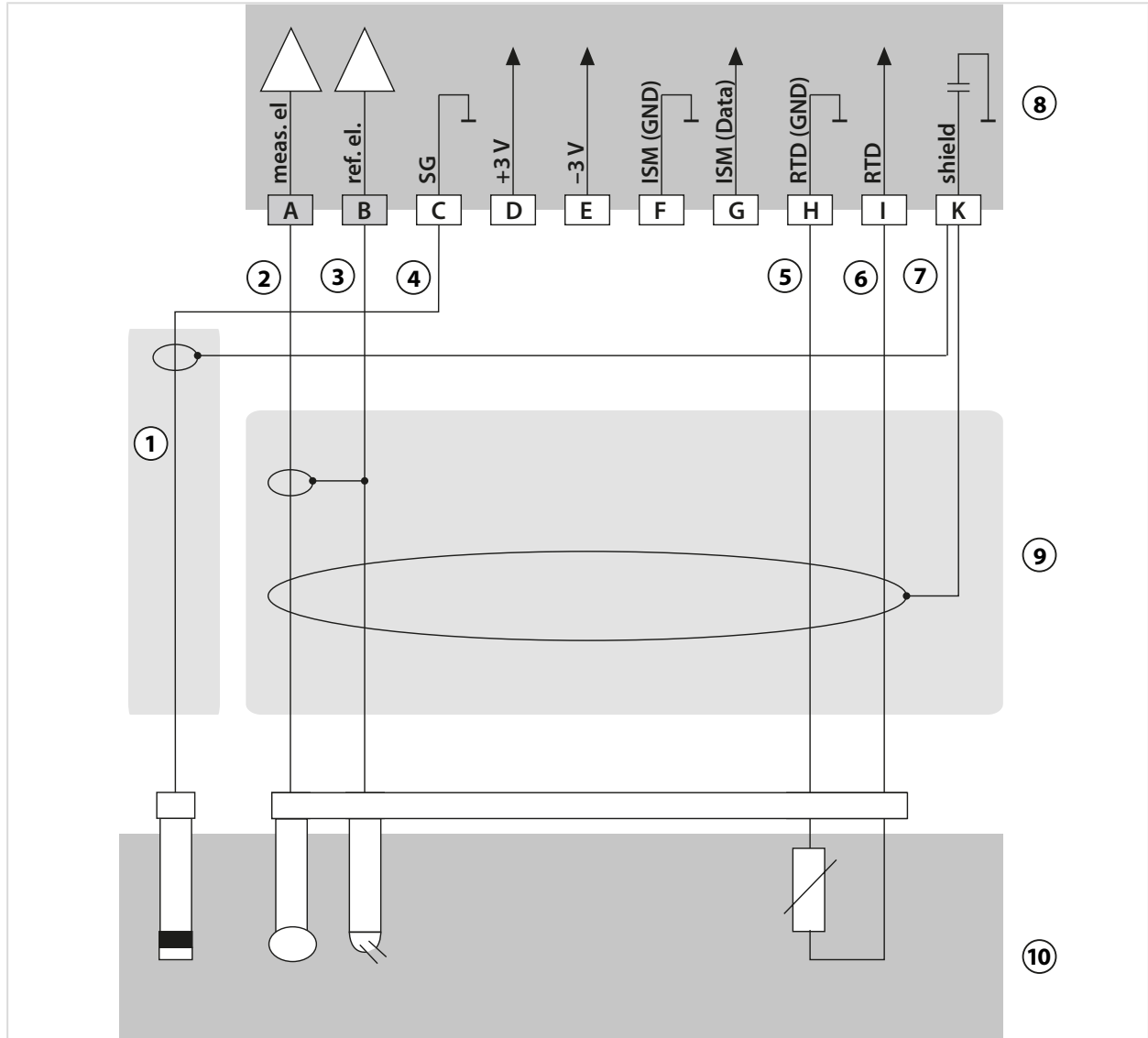

1 Equipotential bonding electrode ZU0073	6 White
2 Core, clear	7 Shield, yellow/green
3 Shield, red	8 pH module
4 Core	9 Cables
5 Green	10 Sensors

Example 5, pH Analog

Measuring task:	pH/ORP, temp., glass impedance, reference impedance
Sensors (example):	PL PETR-120VP (pH/ORP combo sensor, SI Analytics)
Cable (example):	CA/VP6ST-003A

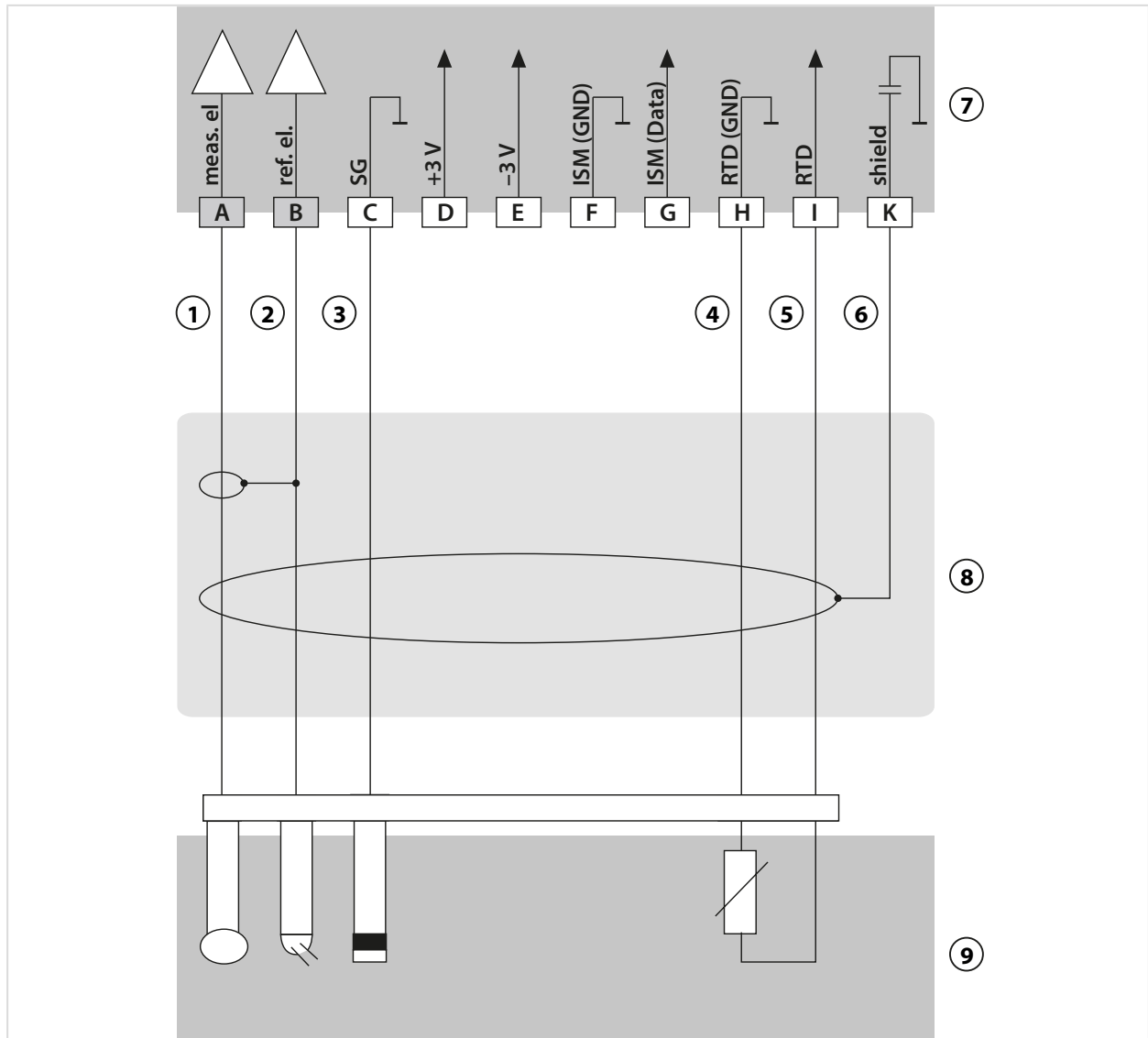

1 Core, transparent	6 Shield, yellow/green
2 Shield, red	7 pH module
3 Blue	8 Cables
4 Green	9 Sensor
5 White	

Example 6, Pfaudler Sensor

Channel II, requires TAN option FW-E017 "Pfaudler sensors"

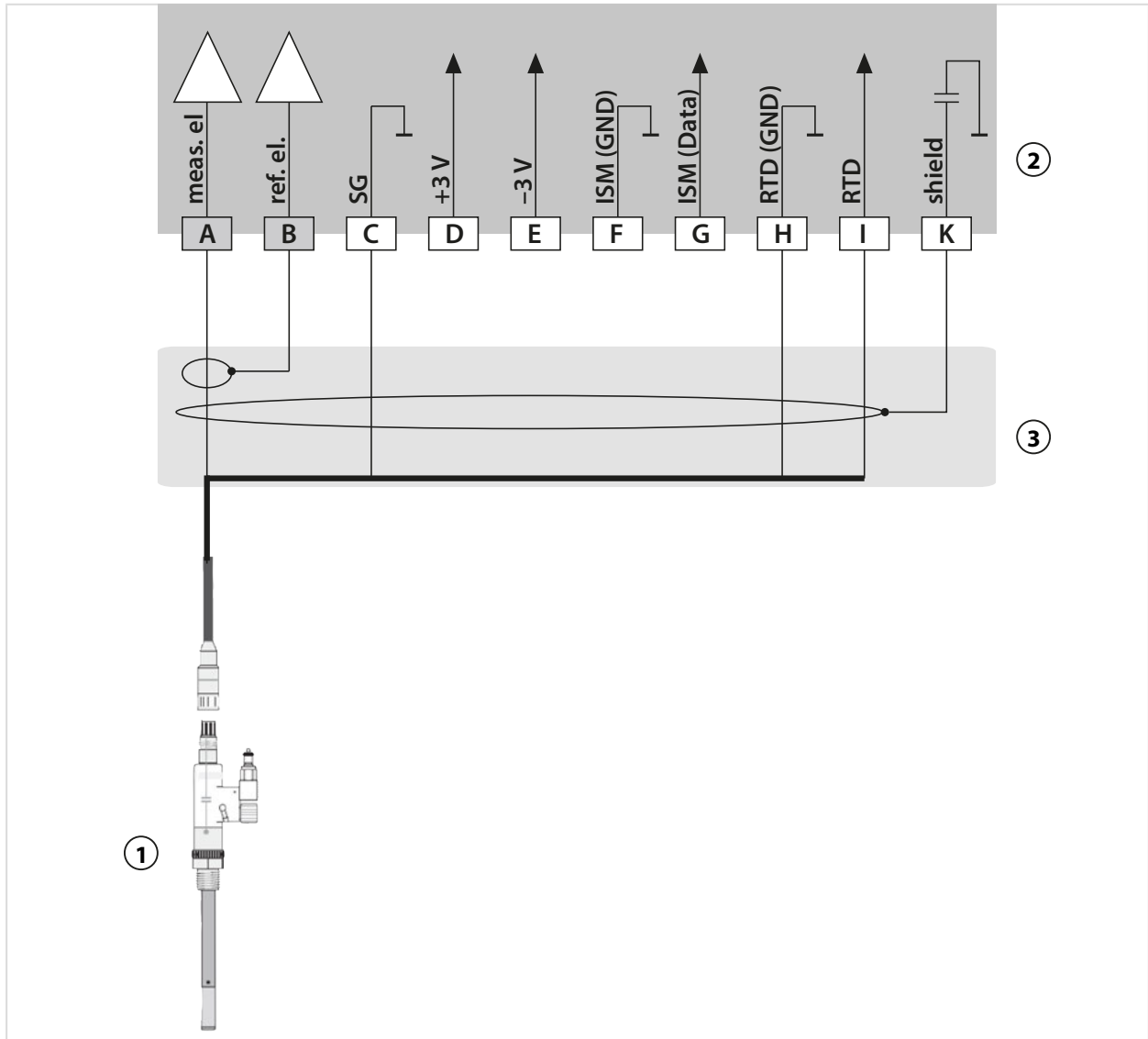

- 1 Pfaudler probe
- 2 pH measuring module
- 3 Cable

Module	pH Reiner with EP ¹⁾ VP connector	Differential, models 18/40 with EP ¹⁾	Models 03/04 with EP ¹⁾	Models 03/04 without EP ¹⁾
A Meas	Coax core	Coax white	Coax white	Coax white
B Ref	Coax shield	Coax brown	Coax brown	Coax brown
C SG	Blue	Blue	Blue	Jumper B/C
...				
H RTD (GND)	Green	Brown	Brown	Brown
I RTD	White	Green, Black	Green, Black	Green, Black
K Shield	Green/Yellow, Gray	Orange, Violet	Orange, Violet	Orange, Violet

¹⁾ Equipotential bonding

14.1.2 ORP Analog Wiring Example

Note: Disable Sensocheck.

Measuring task:	ORP, temp., glass impedance, reference impedance
Sensors (example):	ORP: SE564X/1-NS8N
Cable (example):	ZU0318

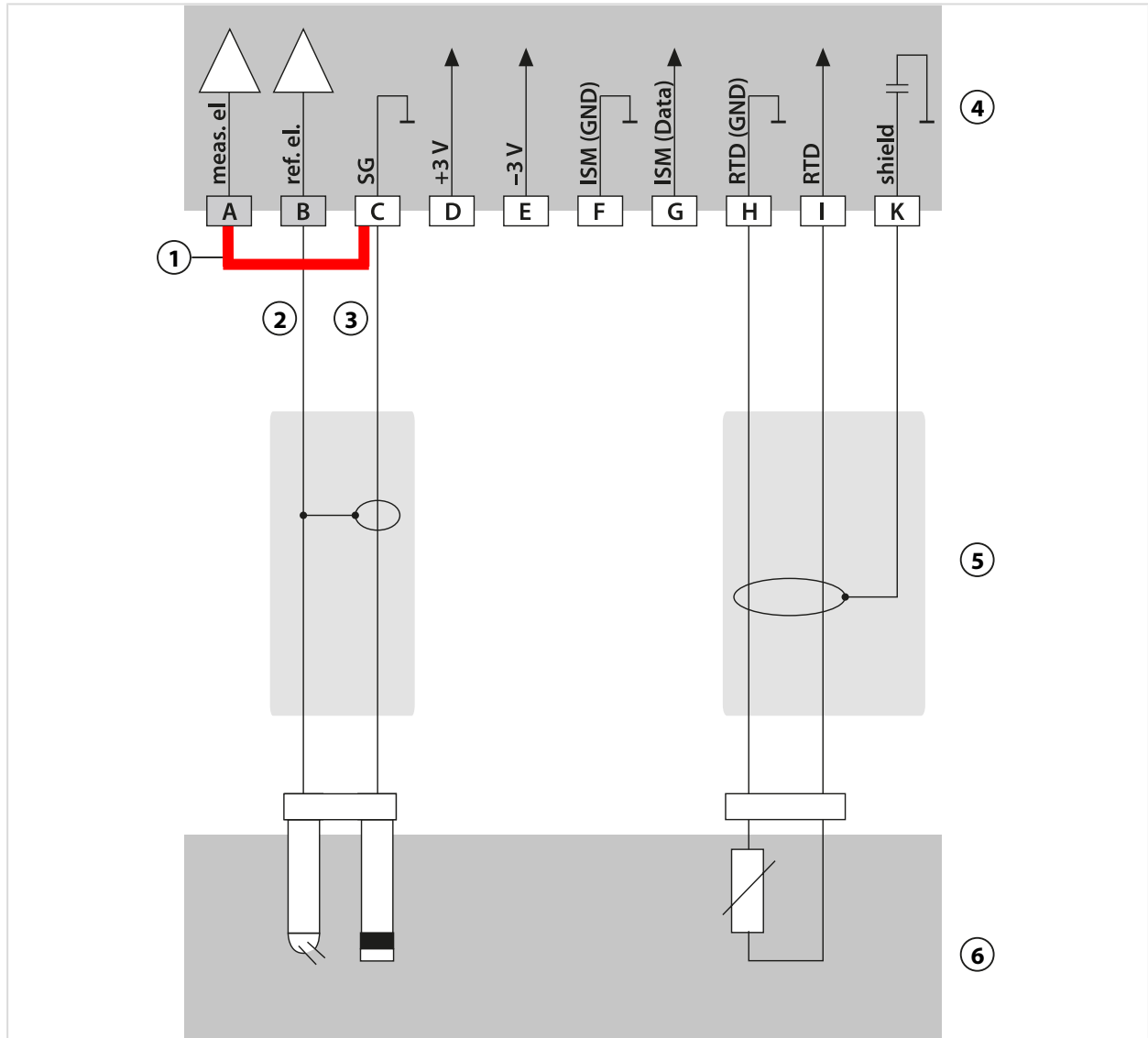

1 Jumper	4 pH measuring module
2 Shield	5 Cable
3 Core	6 Sensors

14.1.3 ISM pH Wiring Example

Channel II, requires TAN option FW-E053 "Digital ISM sensors"

Measuring task:	pH/ORP, temp., glass impedance, reference impedance
Sensors (example):	InPro 4260i (Mettler-Toledo)
Cable (example):	AK9 (Mettler-Toledo)

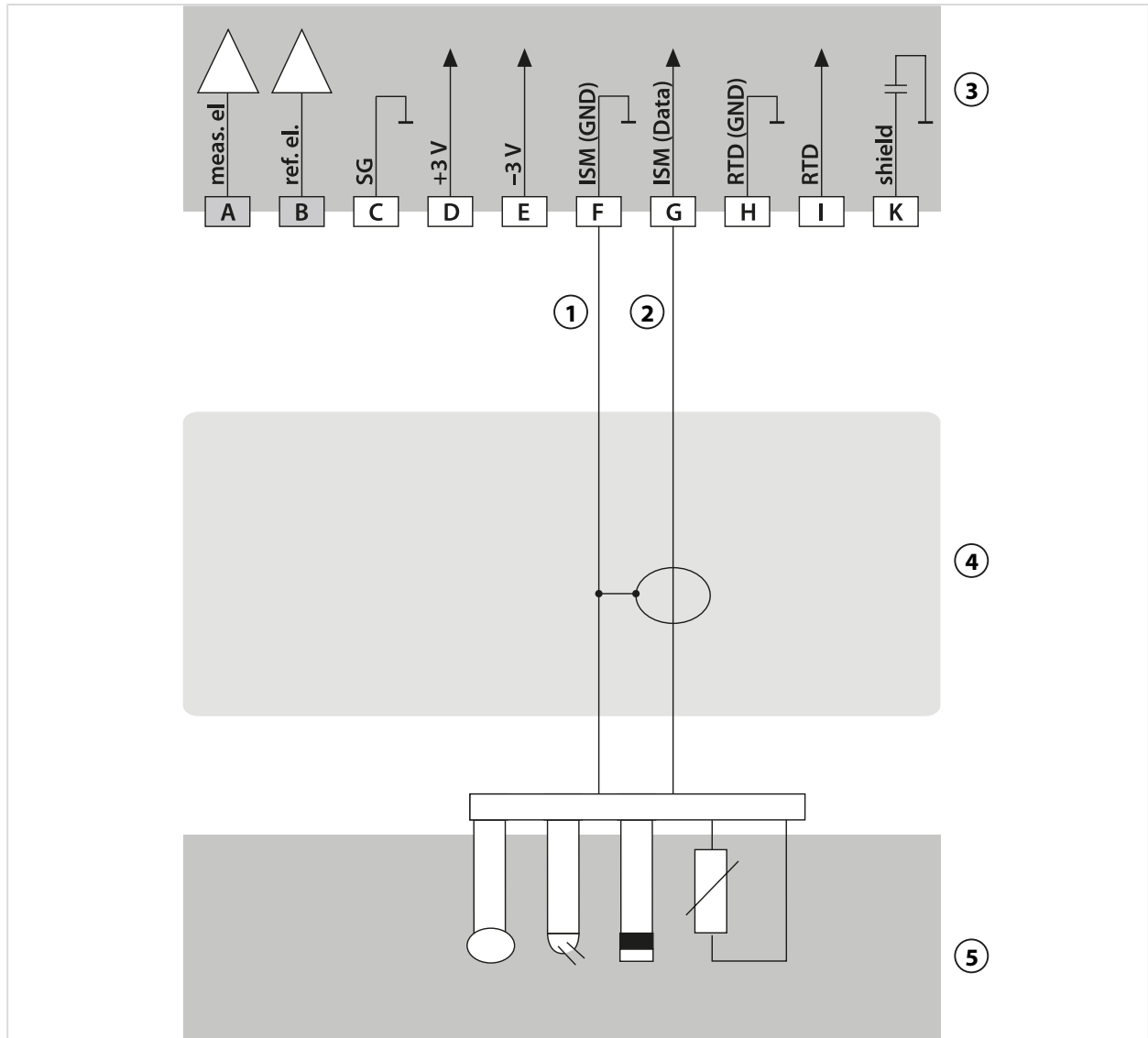

1 Shield	4 Cables
2 Core	5 Sensor
3 pH module	

14.1.4 Contacting Conductivity Wiring Examples

Example 1, Cond

Measuring task: Conductivity, temperature

Sensors (principle): 4 electrodes

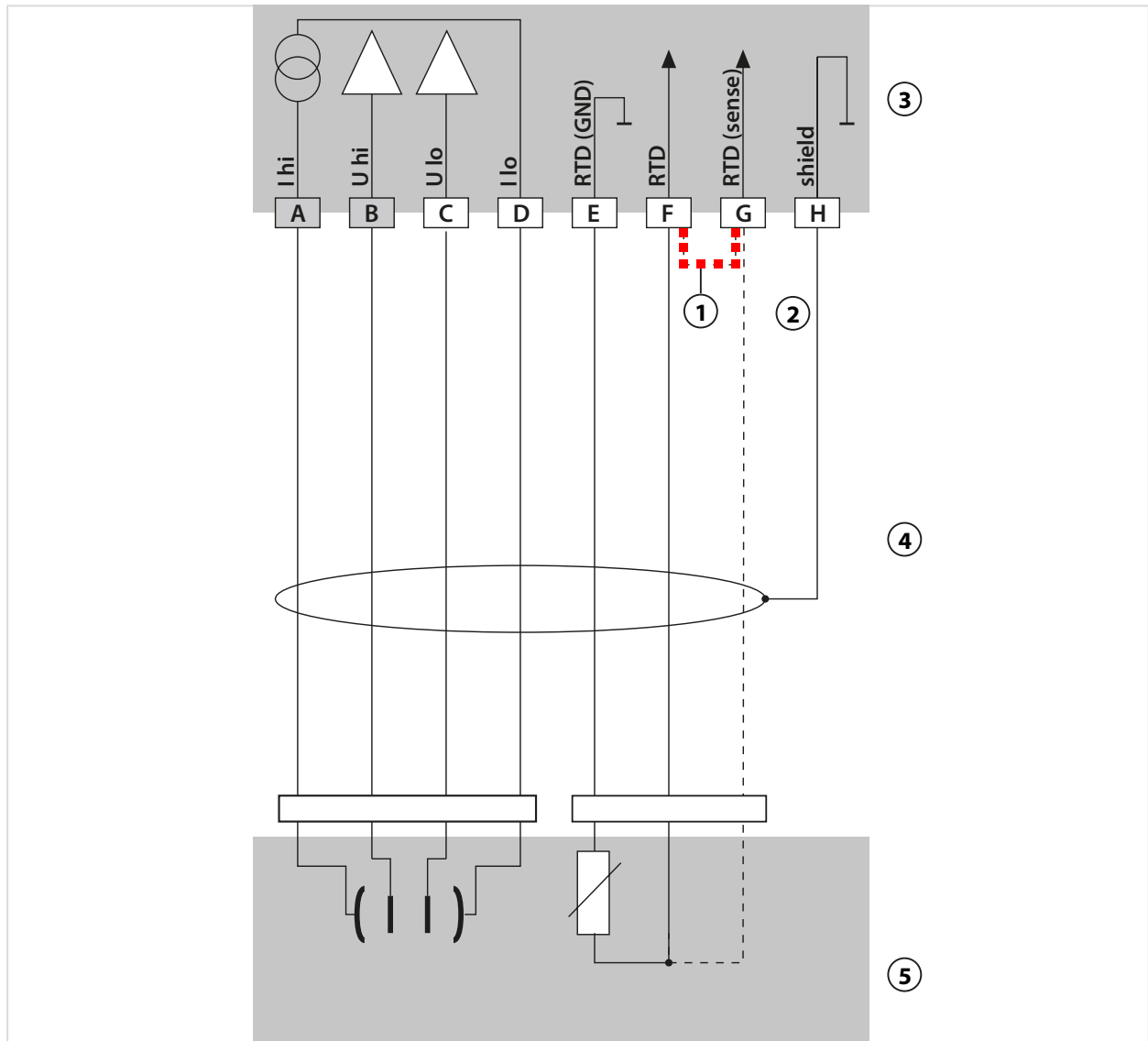

1 Place jumper across F and G when a 2-wire temperature probe is used!

2 Shield

4 Cables

3 Cond module

5 Sensors

Example 2, Cond

Measuring task: Conductivity, temperature
 Sensors (principle): 2 electrodes, coaxial

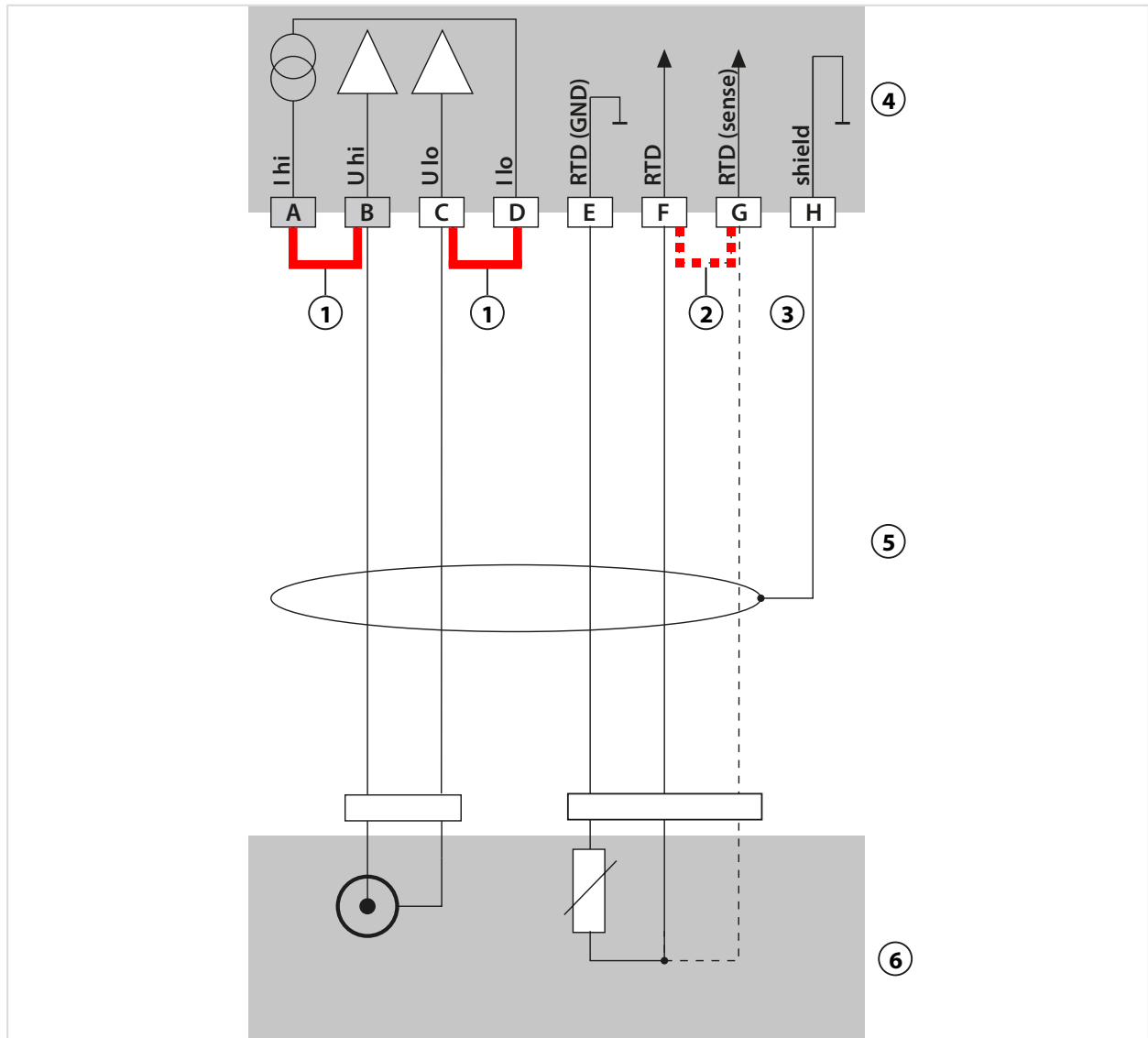

- | | |
|--|---------------|
| 1 Jumper! | 4 Cond module |
| 2 Place jumper across F and G when a 2-wire temperature probe is used! | 5 Cables |
| 3 Shield | 6 Sensors |

Example 3, Cond

Measuring task: Conductivity, temperature
 Sensors (example): 2-electrode sensor, SE604, cable ZU0645

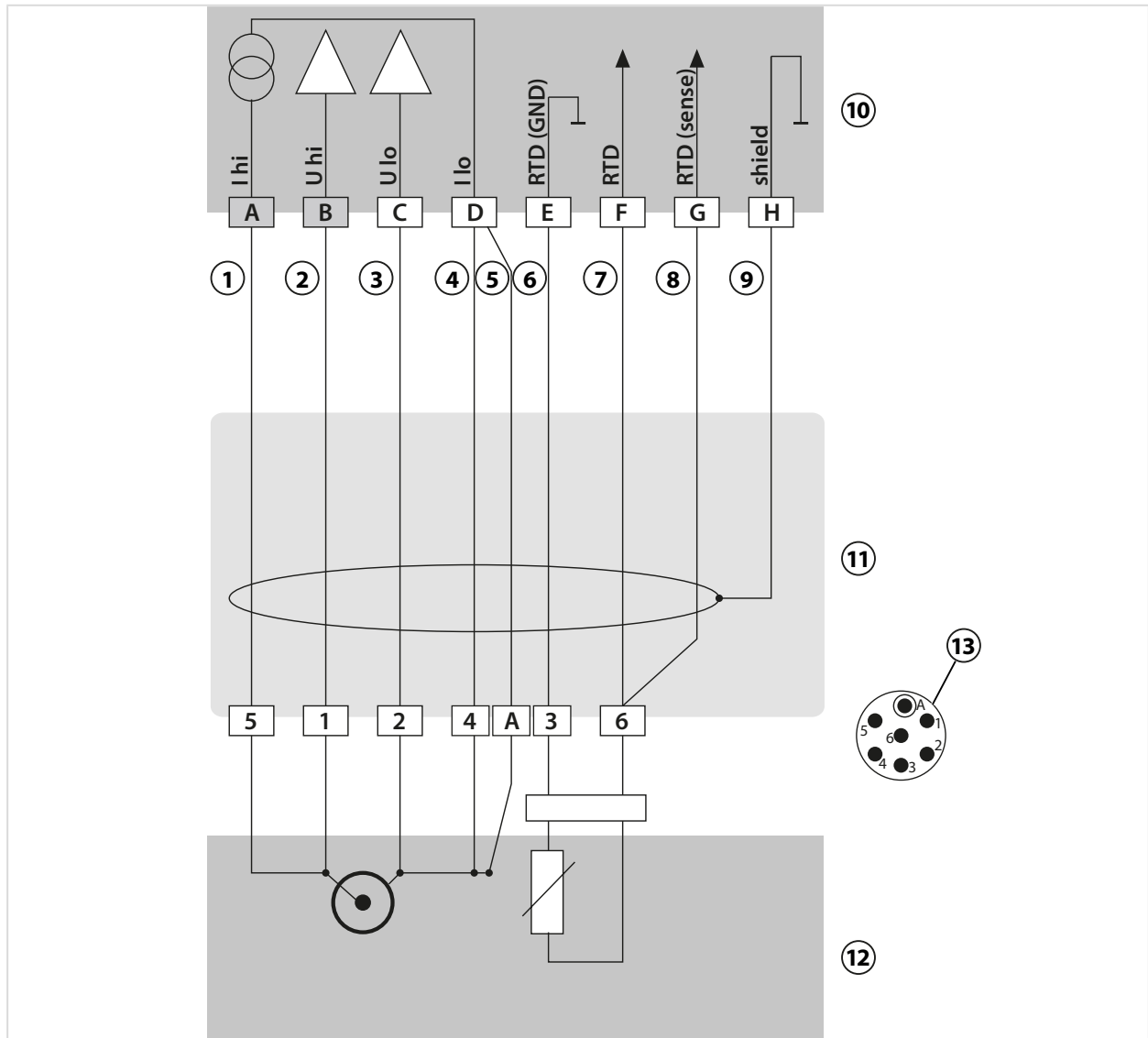

1 White	8 Red
2 Pink	9 Black, shield
3 Brown	10 Cond module
4 Gray	11 Cables
5 Blue	12 Sensors
6 Green	13 Sensor head connector
7 Yellow	

Example 4, Cond

Measuring task: Conductivity, temperature
 Sensors (example): 2-electrode sensor SE610

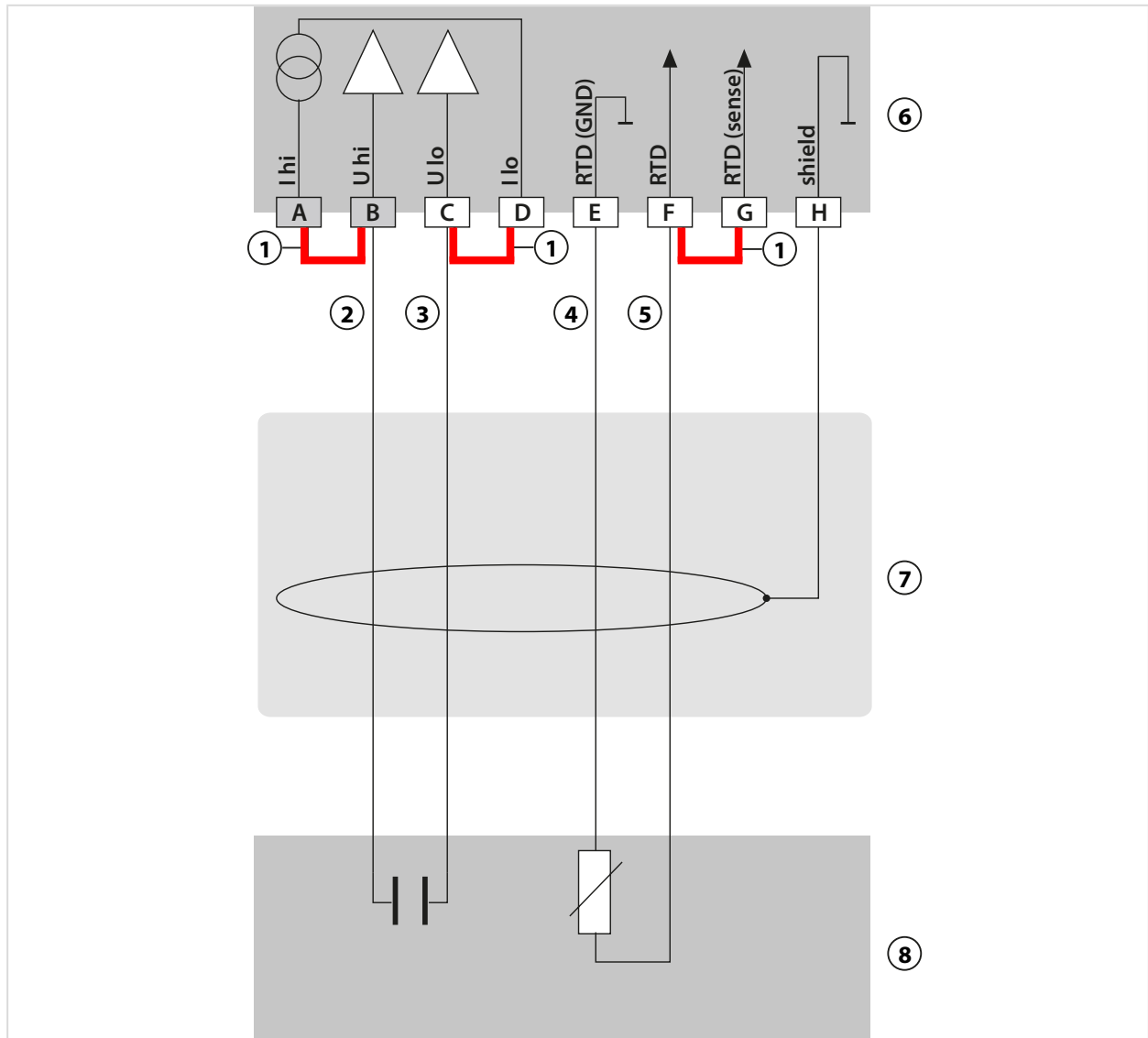

1 Jumper!	5 Yellow
2 Brown	6 Cond module
3 White	7 Fixed cable
4 Green	8 Sensors

Example 5, Cond

Measuring task:	Conductivity, temperature
Sensors (example):	2-electrode sensor SE620
VP cable	e.g., CA/VP6ST-003A

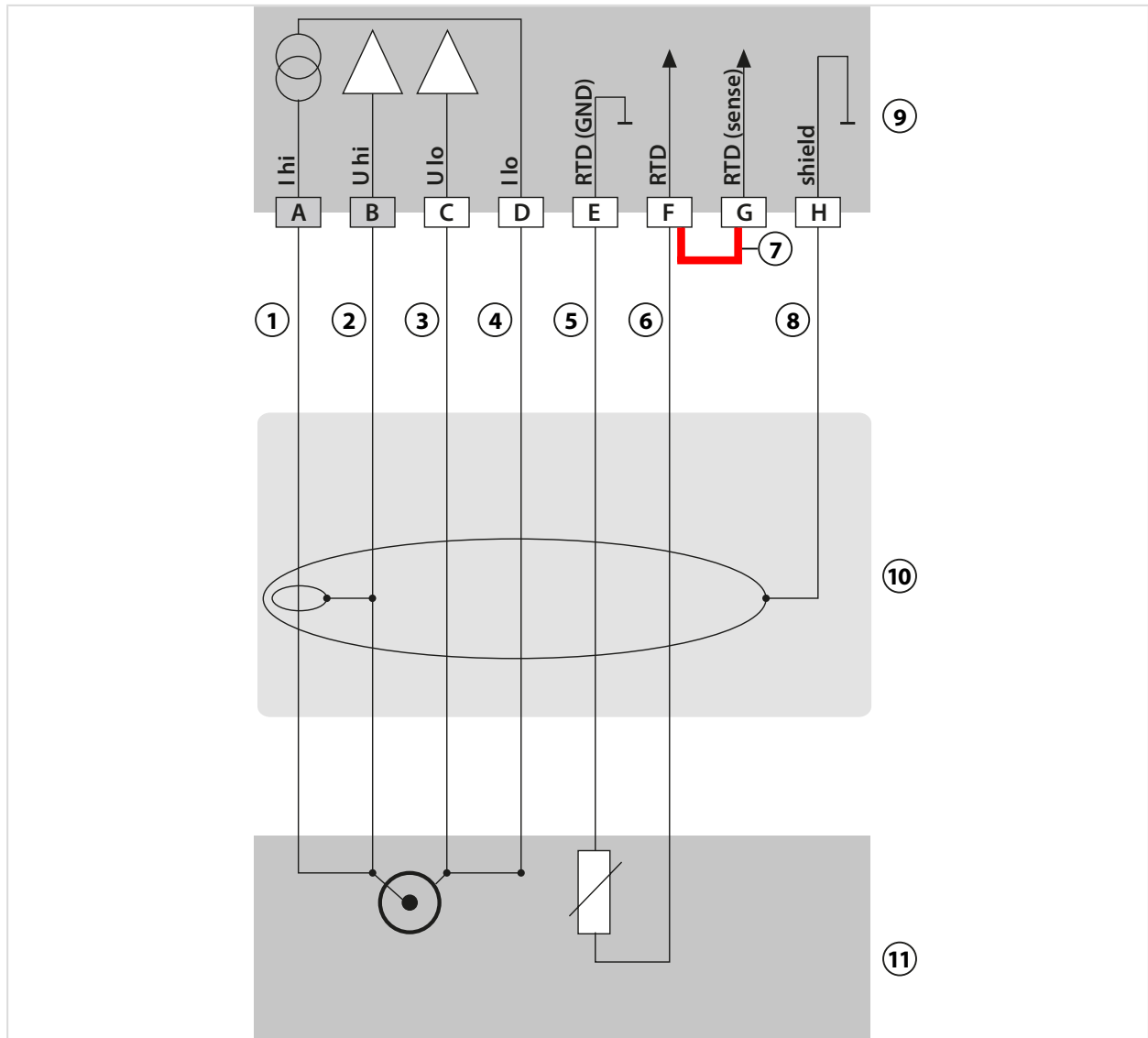

1 Coax core	7 Jumper!
2 Coax shield	8 Shield
3 Gray	9 Cond module
4 Blue	10 VP cable
5 Green	11 Sensors
6 White	

Example 6, Cond

Measuring task: Conductivity, temperature
 Sensors (example): 2-electrode sensor SE630

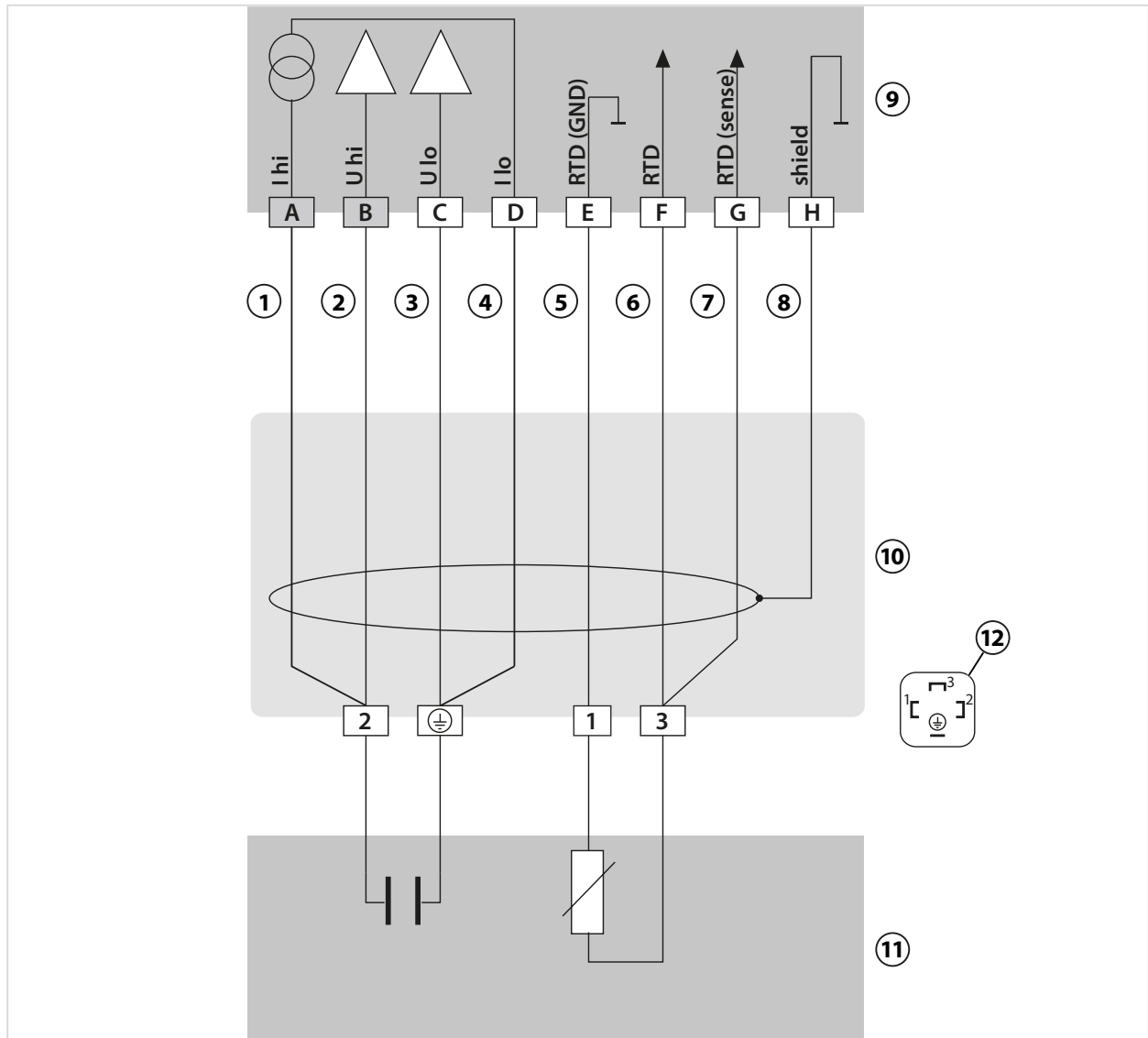

1 Brown	7 Pink
2 Yellow	8 Black, shield
3 Green	9 Cond module
4 White	10 Cables
5 Gray	11 Sensors
6 Red	12 Sensor head connector

Example 7, Cond

Measuring task:	Conductivity, temperature
Sensors (example):	4-electrode fringe-field sensor, SE600/SE603

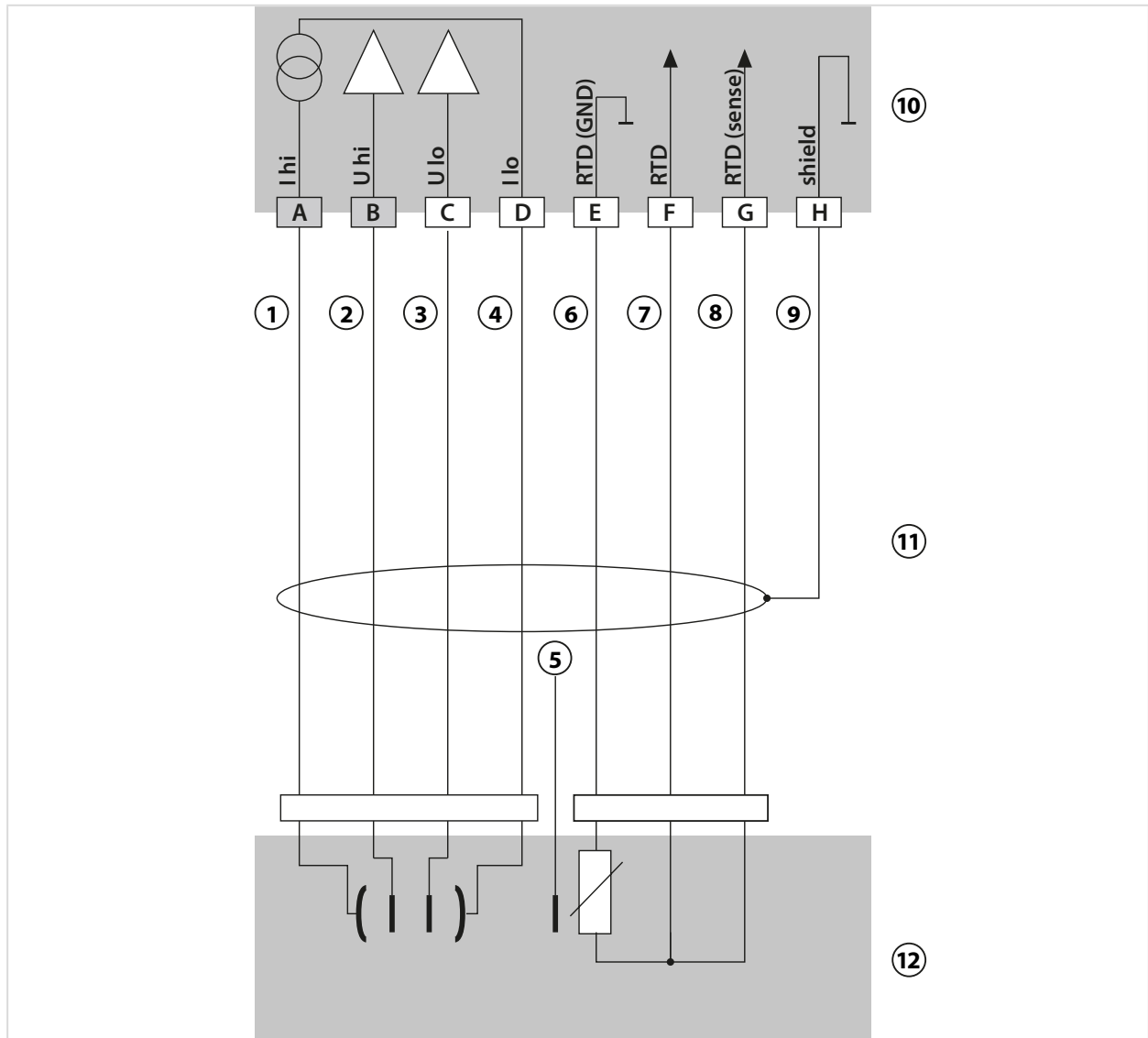

1 Gray	7 Yellow
2 Pink	8 Green
3 Blue	9 Shield yellow/green
4 Red	10 Cond module
5 Brown, do not connect	11 Cables
6 White/green	12 Sensors

14.1.5 Inductive Conductivity Wiring Examples

Example 1, Condl

Measuring task: Inductive conductivity/temperature

Sensors: SE655 or SE656

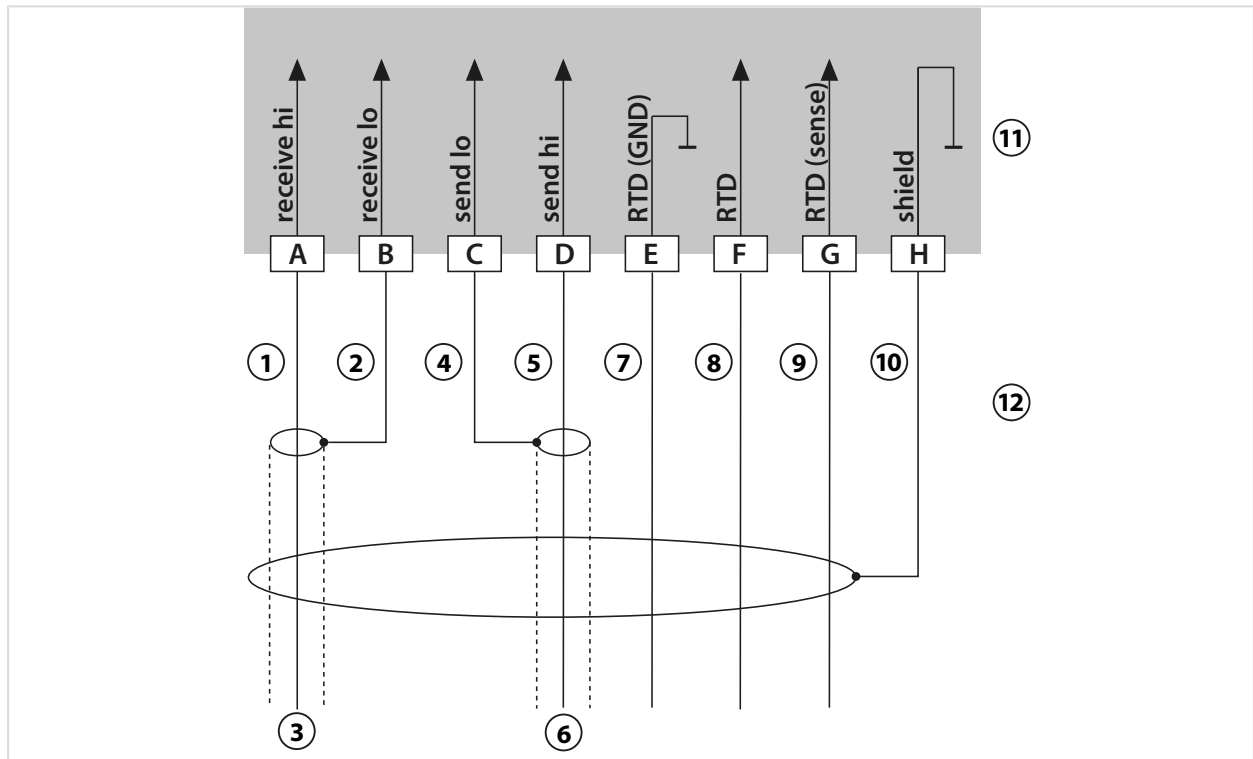

1 Core	7 Green
2 Shield	8 White
3 Coax red	9 Yellow
4 Shield	10 Shield green/yellow
5 Core	11 Condl module
6 Coax white	12 Cables

Example 2, Condl

Measuring task: Conductivity, temperature
 Sensor: SE660

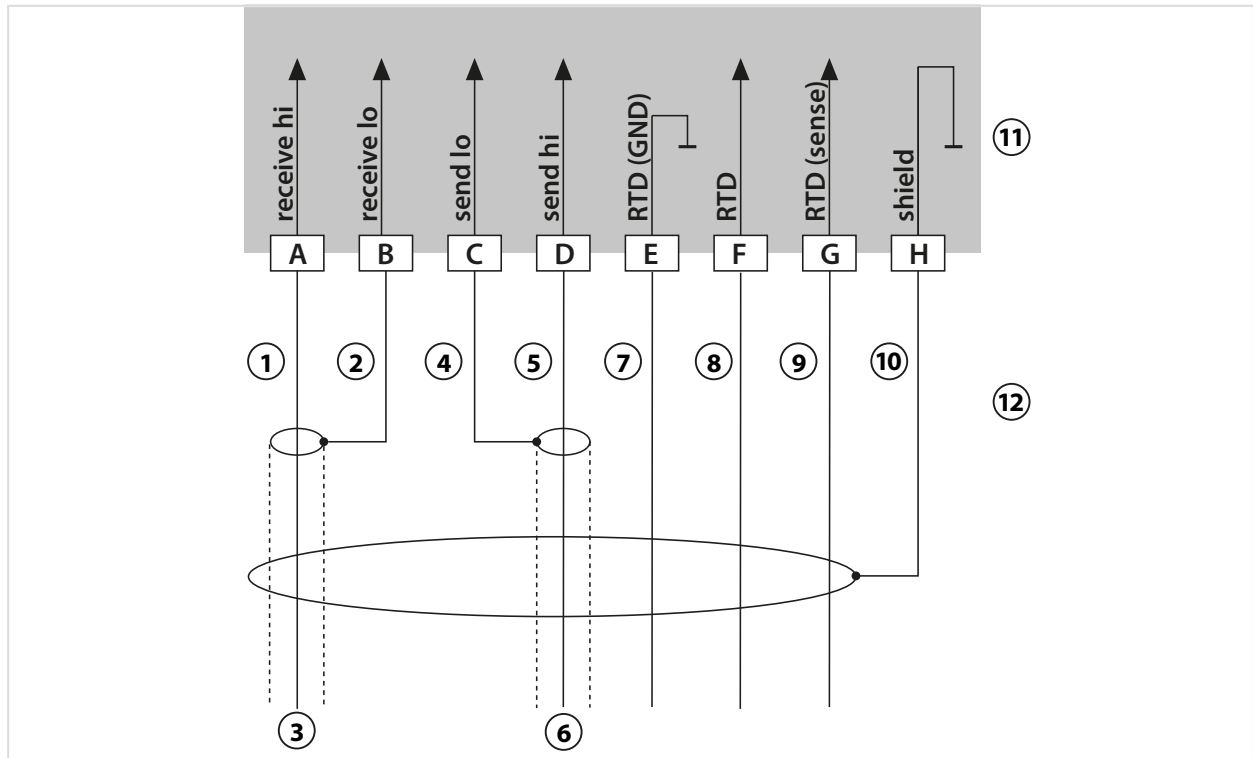

1 Core	7 Green
2 Shield	8 White
3 Coax red	9 Yellow
4 Shield	10 Shield green/yellow
5 Core	11 Condl module
6 Coax BK	12 Cables

14.1.6 Dual Conductivity Wiring Examples

Example 1, Dual Conductivity

Measuring task: Dual conductivity, temperature

Sensors A, B: 2x 2-electrode conductivity sensors

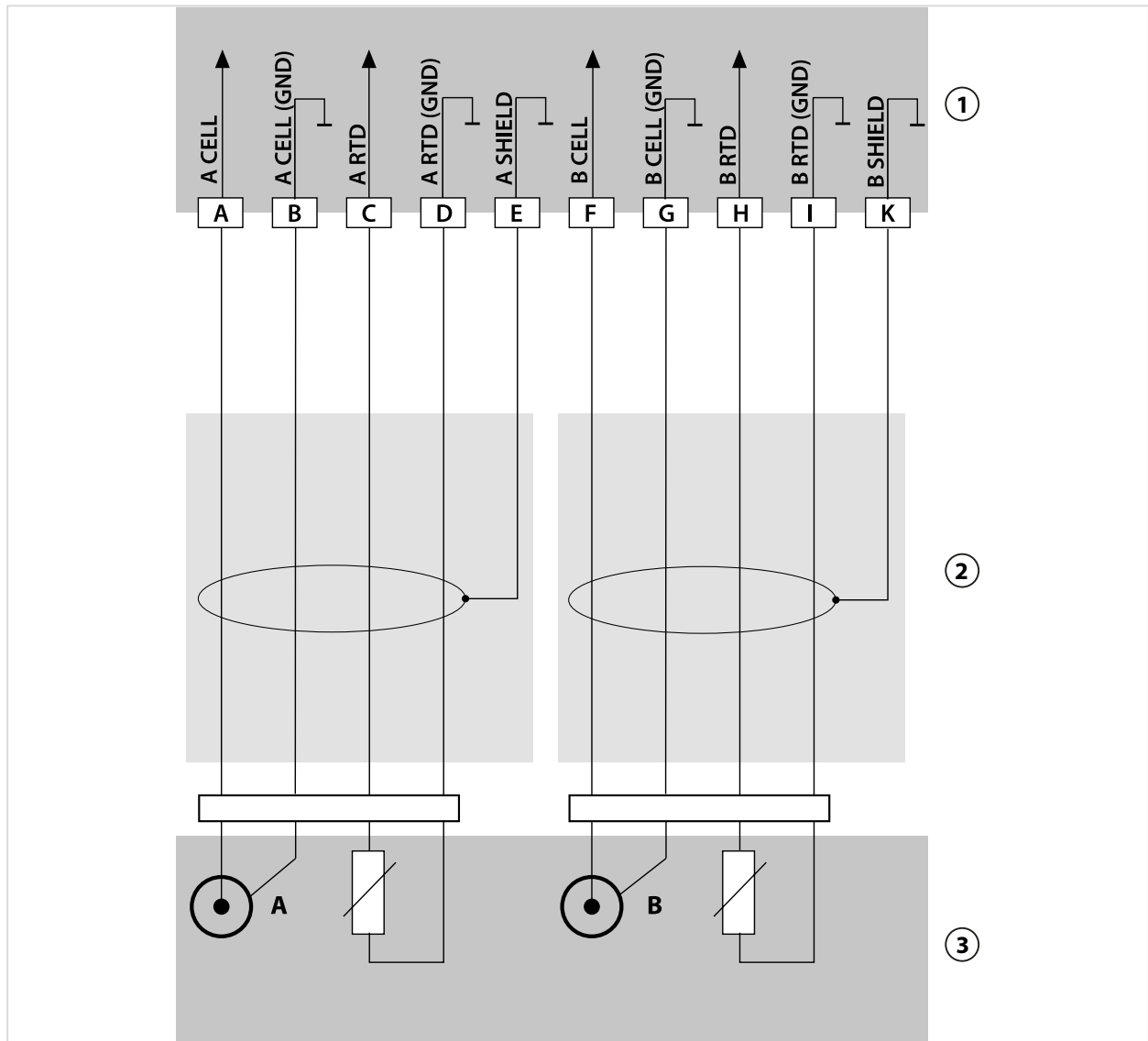

1 MK-CC065N module

3 Sensors

2 2x cable

Example 2, Dual Conductivity

Measuring task:	Dual conductivity, temperature
Sensors A, B:	2x SE604 2-electrode conductivity sensor

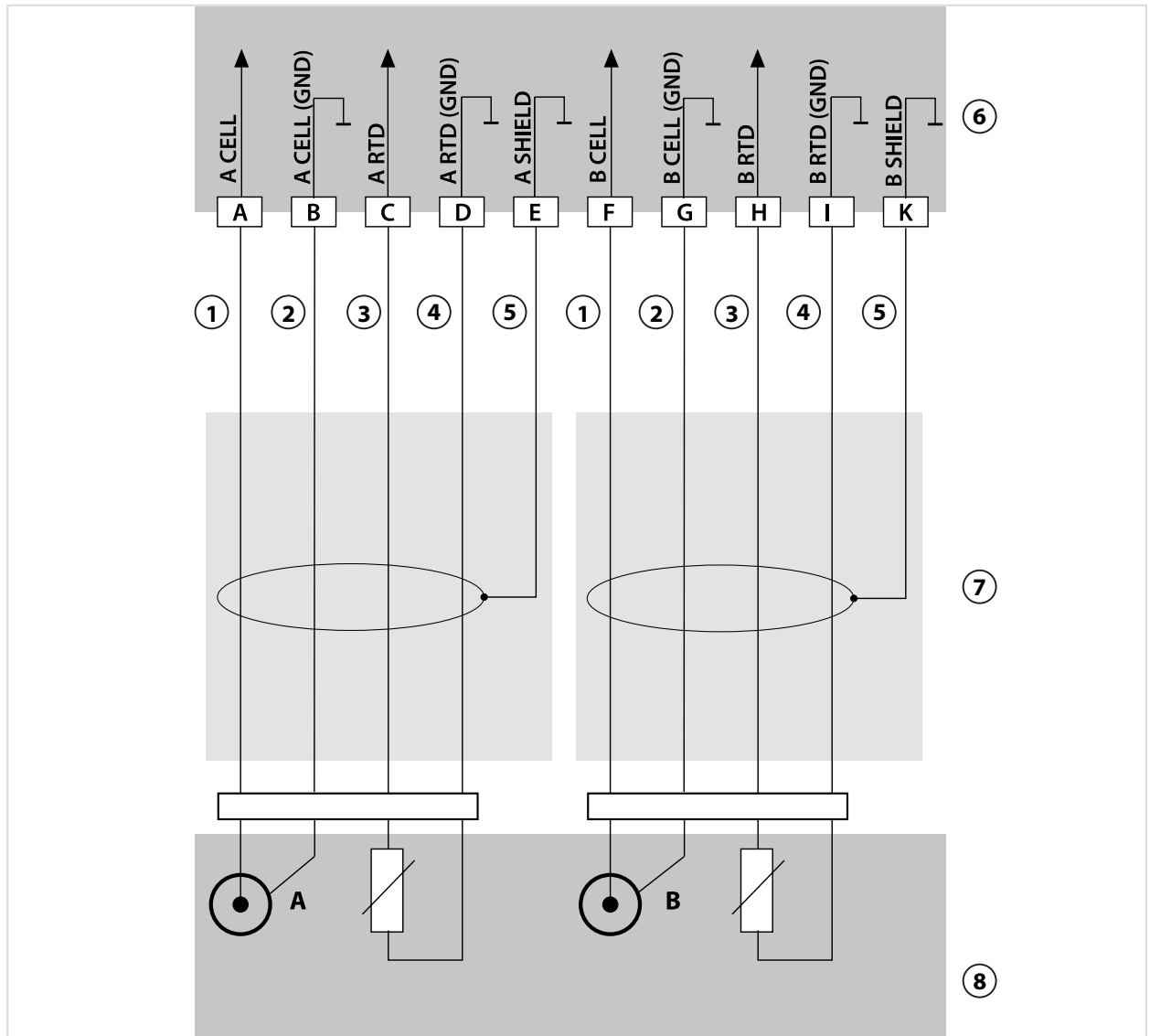

1 White/pink	5 Black
2 Brown/gray	6 MK-CC065N module
3 Yellow/red	7 2x ZU0645 cable
4 Green	8 Sensors

Example 3, Dual Conductivity

Measuring task:	Dual conductivity, temperature
Sensors A, B:	2x SE610 2-electrode conductivity sensor

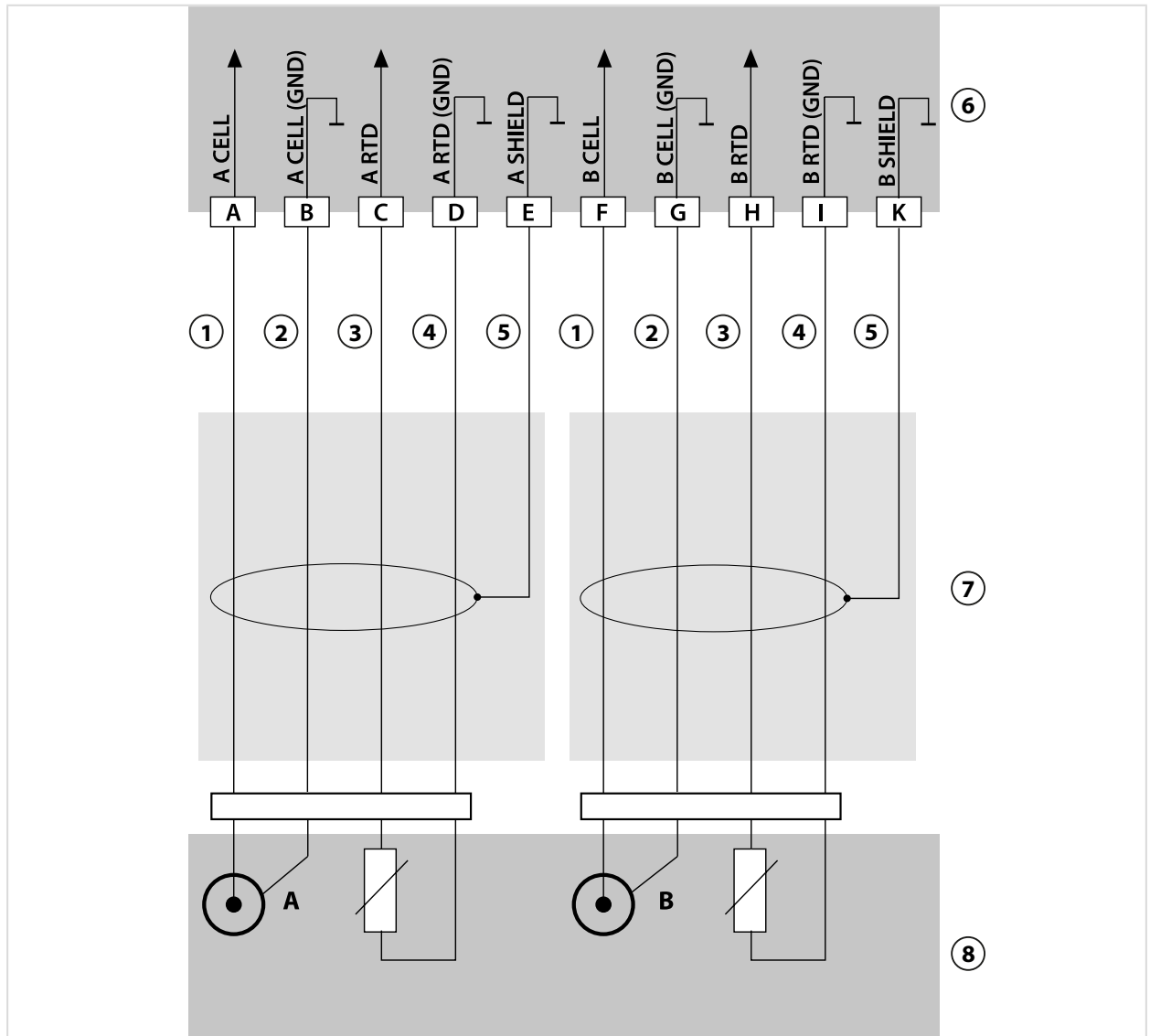

1 White	5 Black
2 Brown	6 MK-CC065N module
3 Yellow	7 2x cable
4 Green	8 Sensors

14.1.7 Oxygen Wiring Examples

Standard Oxygen Wiring Example

Measuring task:	Oxygen (standard, amperometric)
Sensors (example):	e.g., SE706
Cable (example):	CA/VP6ST-003A (ZU0313)

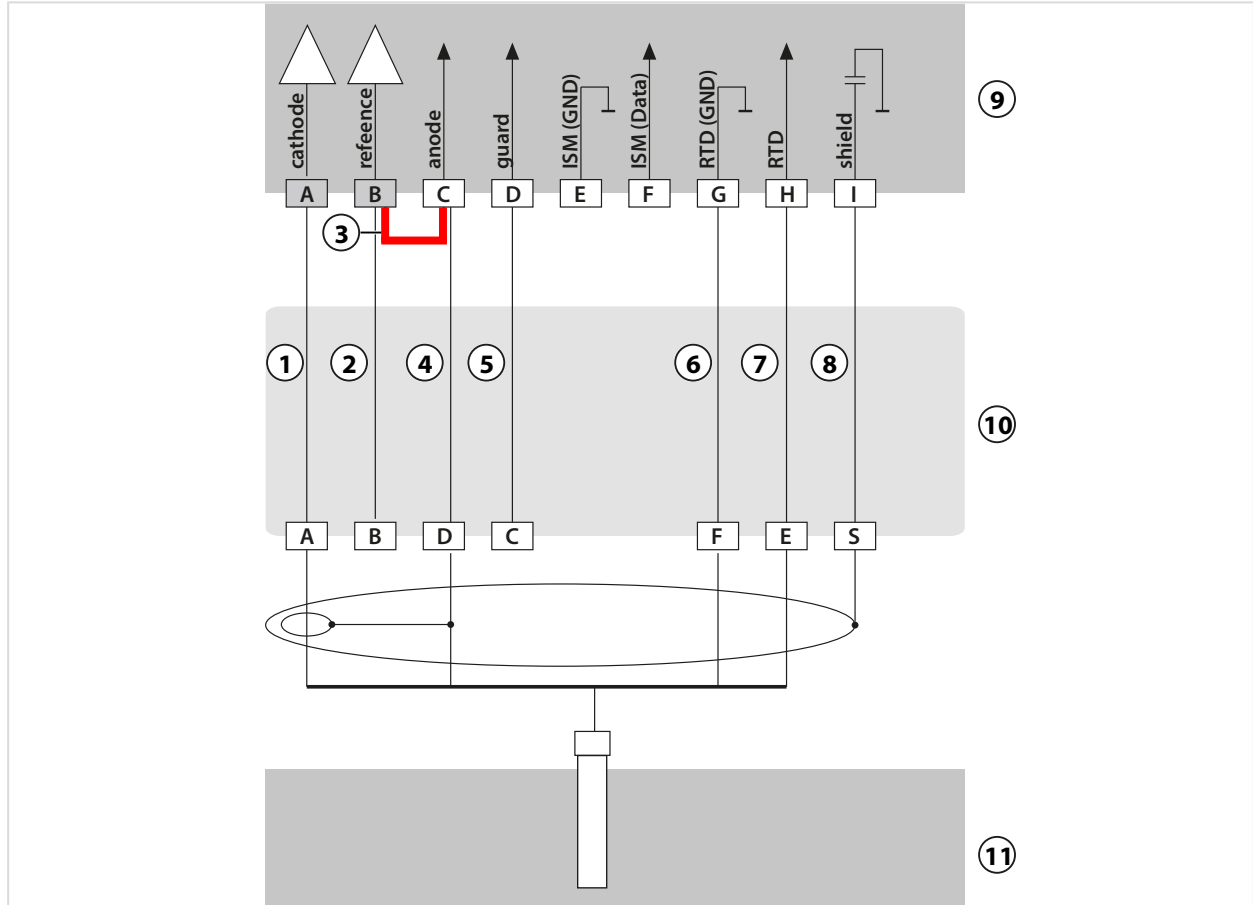

1 Core	5 Gray
2 Blue	6 Green
3 Jumper!	7 White
4 Shield	8 Outer shield

Trace Oxygen Measurement Wiring Example

Measuring task:	Trace oxygen measurement, TAN option FW-E015
Sensors (example):	Model "01" (e.g., SE707)
Cable (example):	CA/VP6ST-003A (ZU0313)

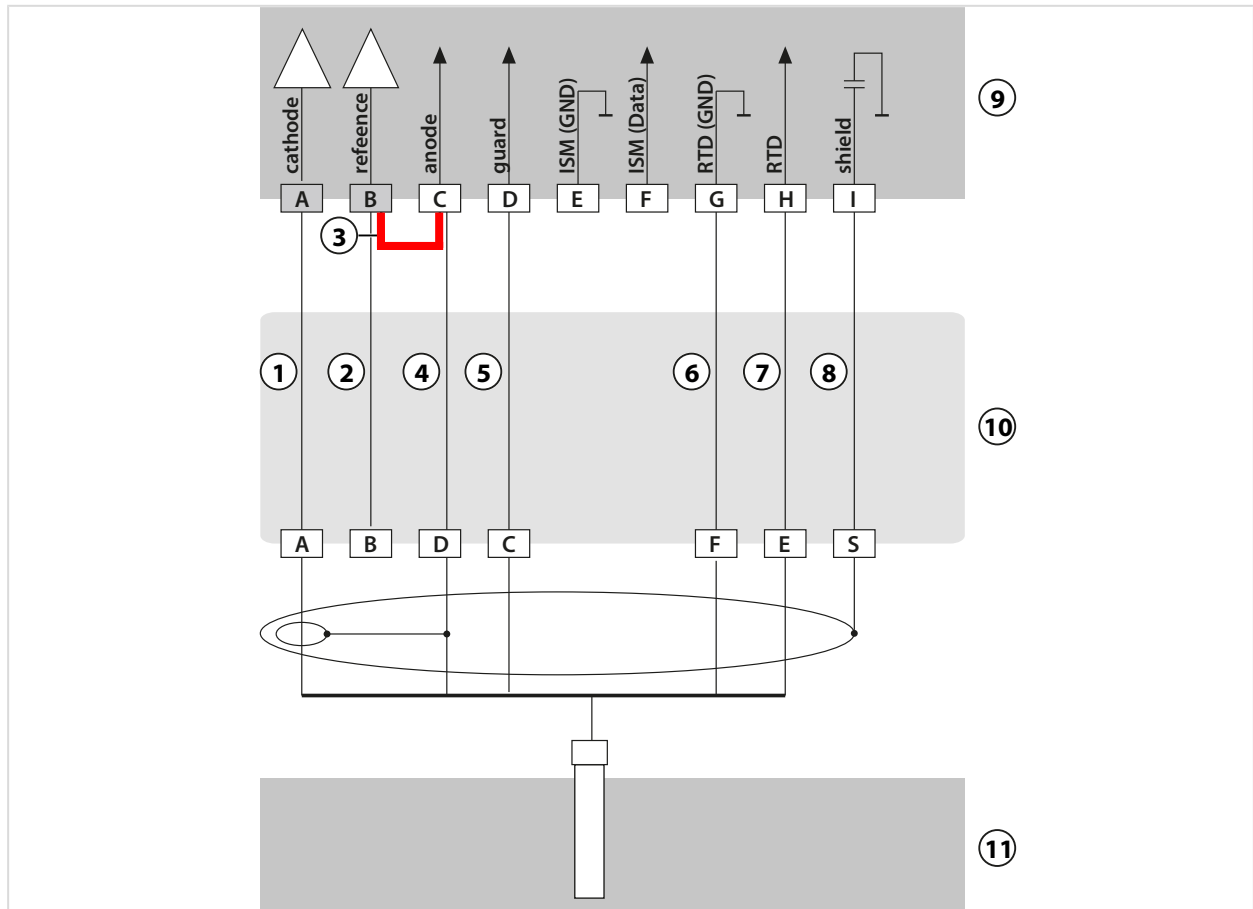

1 Core	5 Gray
2 Blue	6 Green
3 Jumper!	7 White
4 Shield	8 Outer shield

ISM Oxygen Wiring Example

Channel II, requires TAN option FW-E053 "Digital ISM sensors"

Measuring task:	Oxygen (standard, amperometric)
Sensors (example):	InPro 6850i (Mettler-Toledo)
Cable (example):	AK9 (Mettler-Toledo)

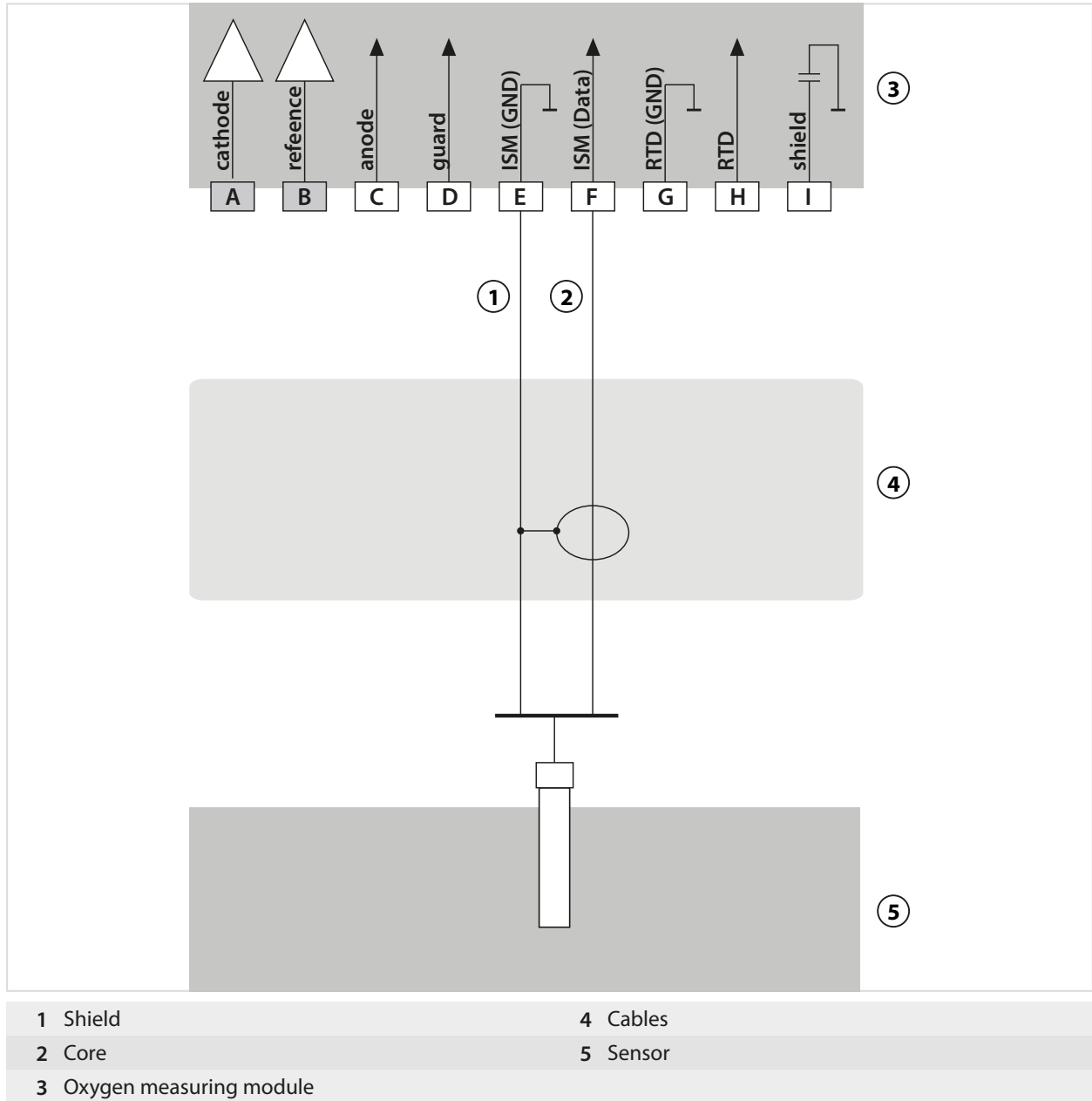

14.2 Buffer Tables

Buffer Table, Knick CaliMat

Nominal values in bold.

°C	pH				
0	2.01	4.05	7.09	9.24	12.58
5	2.01	4.04	7.07	9.16	12.39
10	2.01	4.02	7.04	9.11	12.26
15	2.00	4.01	7.02	9.05	12.13
20	2.00	4.00	7.00	9.00	12.00
25	2.00	4.01	6.99	8.95	11.87
30	2.00	4.01	6.98	8.91	11.75
35	2.00	4.01	6.96	8.88	11.64
40	2.00	4.01	6.96	8.85	11.53
50	2.00	4.01	6.96	8.79	11.31
60	2.00	4.00	6.96	8.73	11.09
70	2.00	4.00	6.96	8.70	10.88
80	2.00	4.00	6.98	8.66	10.68
90	2.00	4.00	7.00	8.64	10.48

Buffer Table, Mettler-Toledo

Nominal values in bold.

°C	pH			
0	2.03	4.01	7.12	9.52
5	2.02	4.01	7.09	9.45
10	2.01	4.00	7.06	9.38
15	2.00	4.00	7.04	9.32
20	2.00	4.00	7.02	9.26
25	2.00	4.01	7.00	9.21
30	1.99	4.01	6.99	9.16
35	1.99	4.02	6.98	9.11
40	1.98	4.03	6.97	9.06
45	1.98	4.04	6.97	9.03
50	1.98	4.06	6.97	8.99
55	1.98	4.08	6.98	8.96
60	1.98	4.10	6.98	8.93
65	1.99	4.13	6.99	8.90
70	1.99	4.16	7.00	8.88
75	2.00	4.19	7.02	8.85
80	2.00	4.22	7.04	8.83
85	2.00	4.26	7.06	8.81
90	2.00	4.30	7.09	8.79
95	2.00	4.35	7.12	8.77

Buffer Table, Merck/Riedel

Nominal values in bold.

°C	pH				
0	2.01	4.05	7.13	9.24	12.58
5	2.01	4.04	7.07	9.16	12.41
10	2.01	4.02	7.05	9.11	12.26
15	2.00	4.01	7.02	9.05	12.10
20	2.00	4.00	7.00	9.00	12.00
25	2.00	4.01	6.98	8.95	11.88
30	2.00	4.01	6.98	8.91	11.72
35	2.00	4.01	6.96	8.88	11.67
40	2.00	4.01	6.95	8.85	11.54
45	2.00	4.01	6.95	8.82	11.44
50	2.00	4.00	6.95	8.79	11.33
55	2.00	4.00	6.95	8.76	11.19
60	2.00	4.00	6.96	8.73	11.04
65	2.00	4.00	6.96	8.72	10.97
70	2.01	4.00	6.96	8.70	10.90
75	2.01	4.00	6.96	8.68	10.80
80	2.01	4.00	6.97	8.66	10.70
85	2.01	4.00	6.98	8.65	10.59
90	2.01	4.00	7.00	8.64	10.48
95	2.01	4.00	7.02	8.64	10.37

Buffer Table, DIN 19267

Nominal values in bold.

°C	pH				
0	1.08	4.67	6.89	9.48	13.95 ¹⁾
5	1.08	4.67	6.87	9.43	13.63 ¹⁾
10	1.09	4.66	6.84	9.37	13.37
15	1.09	4.66	6.82	9.32	13.16
20	1.09	4.65	6.80	9.27	12.96
25	1.09	4.65	6.79	9.23	12.75
30	1.10	4.65	6.78	9.18	12.61
35	1.10	4.65	6.77	9.13	12.45
40	1.10	4.66	6.76	9.09	12.29
45	1.10	4.67	6.76	9.04	12.09
50	1.11	4.68	6.76	9.00	11.89
55	1.11	4.69	6.76	8.96	11.79
60	1.11	4.70	6.76	8.92	11.69
65	1.11	4.71	6.76	8.90	11.56
70	1.11	4.72	6.76	8.88	11.43
75	1.11	4.73	6.77	8.86	11.31
80	1.12	4.75	6.78	8.85	11.19
85	1.12	4.77	6.79	8.83	11.09
90	1.13	4.79	6.80	8.82	10.99
95	1.13 ¹⁾	4.82 ¹⁾	6.81 ¹⁾	8.81 ¹⁾	10.89 ¹⁾

¹⁾ extrapolated

Buffer Table, NIST Standard (DIN 19266: 2015-05)

Nominal values in bold.

°C	pH				
0	1.666	4.000	6.984	9.464	
5	1.668	3.998	6.951	9.395	13.207
10	1.670	3.997	6.923	9.332	13.003
15	1.672	3.998	6.900	9.276	12.810
20	1.675	4.000	6.881	9.225	12.627
25	1.679	4.005	6.865	9.180	12.454
30	1.683	4.011	6.853	9.139	12.289
35	1.688	4.018	6.844	9.102	12.133
37		4.022	6.841	9.088	
38	1.691				12.043
40	1.694	4.027	6.838	9.068	11.984
45					11.841
50	1.707	4.050	6.833	9.011	11.705
55	1.715	4.075	6.834	8.985	11.574
60	1.723	4.091	6.836	8.962	11.449
70	1.743	4.126	6.845	8.921	
80	1.766	4.164	6.859	8.885	
90	1.792	4.205	6.877	8.850	
95	1.806	4.227	6.886	8.833	

Note: The actual pH(S) values of the individual batches of the reference materials are documented in a certificate of an accredited laboratory. This certificate is supplied with the respective buffers. Only these pH(S) values shall be used as standard values for the secondary reference buffer materials. Correspondingly, this standard does not include a table with standard pH values for practical use. The table above only provides examples of pH(S) values for orientation.

Buffer Table, NIST Technical Buffers

Nominal values in bold.

°C	pH				
0	1.67	4.00	7.115	10.32	13.42
5	1.67	4.00	7.085	10.25	13.21
10	1.67	4.00	7.06	10.18	13.01
15	1.67	4.00	7.04	10.12	12.80
20	1.675	4.00	7.015	10.06	12.64
25	1.68	4.005	7.00	10.01	12.46
30	1.68	4.015	6.985	9.97	12.30
35	1.69	4.025	6.98	9.93	12.13
40	1.69	4.03	6.975	9.89	11.99
45	1.70	4.045	6.975	9.86	11.84
50	1.705	4.06	6.97	9.83	11.71
55	1.715	4.075	6.97	9.83 ¹⁾	11.57
60	1.72	4.085	6.97	9.83 ¹⁾	11.45
65	1.73	4.10	6.98	9.83 ¹⁾	11.45 ¹⁾
70	1.74	4.13	6.99	9.83 ¹⁾	11.45 ¹⁾
75	1.75	4.14	7.01	9.83 ¹⁾	11.45 ¹⁾
80	1.765	4.16	7.03	9.83 ¹⁾	11.45 ¹⁾
85	1.78	4.18	7.05	9.83 ¹⁾	11.45 ¹⁾
90	1.79	4.21	7.08	9.83 ¹⁾	11.45 ¹⁾
95	1.805	4.23	7.11	9.83 ¹⁾	11.45 ¹⁾

Buffer Table, Hamilton Duracal

Nominal values in bold.

°C	pH				
0	1.99	4.01	7.12	10.23	12.58
5	1.99	4.01	7.09	10.19	12.46
10	2.00	4.00	7.06	10.15	12.34
15	2.00	4.00	7.04	10.11	12.23
20	2.00	4.00	7.02	10.06	12.11
25	2.00	4.01	7.00	10.01	12.00
30	1.99	4.01	6.99	9.97	11.90
35	1.98	4.02	6.98	9.92	11.80
40	1.98	4.03	6.97	9.86	11.70
45	1.97	4.04	6.97	9.83	11.60
50	1.97	4.05	6.97	9.79	11.51
55	1.98	4.06	6.98	9.75	11.42
60	1.98	4.08	6.98	9.72	11.33
65	1.98	4.10 ¹⁾	6.99 ¹⁾	9.69 ¹⁾	11.24
70	1.99	4.12 ¹⁾	7.00 ¹⁾	9.66 ¹⁾	11.15
75	1.99	4.14 ¹⁾	7.02 ¹⁾	9.63 ¹⁾	11.06
80	2.00	4.16 ¹⁾	7.04 ¹⁾	9.59 ¹⁾	10.98
85	2.00	4.18 ¹⁾	7.06 ¹⁾	9.56 ¹⁾	10.90
90	2.00	4.21 ¹⁾	7.09 ¹⁾	9.52 ¹⁾	10.82
95	2.00	4.24 ¹⁾	7.12 ¹⁾	9.48 ¹⁾	10.74

¹⁾ values added

Buffer Table, Kraft

Nominal values in bold.

°C	pH				
0	2.01	4.05	7.13	9.24	11.47 ¹⁾
5	2.01	4.04	7.07	9.16	11.47
10	2.01	4.02	7.05	9.11	11.31
15	2.00	4.01	7.02	9.05	11.15
20	2.00	4.00	7.00	9.00	11.00
25	2.00	4.01	6.98	8.95	10.85
30	2.00	4.01	6.98	8.91	10.71
35	2.00	4.01	6.96	8.88	10.57
40	2.00	4.01	6.95	8.85	10.44
45	2.00	4.01	6.95	8.82	10.31
50	2.00	4.00	6.95	8.79	10.18
55	2.00	4.00	6.95	8.76	10.18 ¹⁾
60	2.00	4.00	6.96	8.73	10.18 ¹⁾
65	2.00	4.00	6.96	8.72	10.18 ¹⁾
70	2.01	4.00	6.96	8.70	10.18 ¹⁾
75	2.01	4.00	6.96	8.68	10.18 ¹⁾
80	2.01	4.00	6.97	8.66	10.18 ¹⁾
85	2.01	4.00	6.98	8.65	10.18 ¹⁾
90	2.01	4.00	7.00	8.64	10.18 ¹⁾
95	2.01	4.00	7.02	8.64	10.18 ¹⁾

Buffer Table, Hamilton A

Nominal values in bold.

°C	pH				
0	1.99	4.01	7.12	9.31	11.42
5	1.99	4.01	7.09	9.24	11.33
10	2.00	4.00	7.06	9.17	11.25
15	2.00	4.00	7.04	9.11	11.16
20	2.00	4.00	7.02	9.05	11.07
25	2.00	4.01	7.00	9.00	11.00
30	1.99	4.01	6.99	8.95	10.93
35	1.98	4.02	6.98	8.90	10.86
40	1.98	4.03	6.97	8.85	10.80
45	1.97	4.04	6.97	8.82	10.73
50	1.97	4.05	6.97	8.78	10.67
55	1.98	4.06	6.98	8.75	10.61
60	1.98	4.08	6.98	8.72	10.55
65	1.98	4.10	6.99	8.70	10.49
70	1.99	4.12	7.00	8.67	10.43
75	1.99	4.14	7.02	8.64	10.38
80	2.00	4.16	7.04	8.62	10.33
85	2.00	4.18	7.06	8.60	10.28
90	2.00	4.21	7.09	8.58	10.23
95	2.00	4.24	7.12	8.56	10.18

¹⁾ values added

Buffer Table, Hamilton B

Nominal values in bold.

°C	pH				
0	1.99	4.01	6.03	9.31	11.42
5	1.99	4.01	6.02	9.24	11.33
10	2.00	4.00	6.01	9.17	11.25
15	2.00	4.00	6.00	9.11	11.16
20	2.00	4.00	6.00	9.05	11.07
25	2.00	4.01	6.00	9.00	11.00
30	1.99	4.01	6.00	8.95	10.93
35	1.98	4.02	6.00	8.90	10.86
40	1.98	4.03	6.01	8.85	10.80
45	1.97	4.04	6.02	8.82	10.73
50	1.97	4.05	6.04	8.78	10.67
55	1.98	4.06	6.06	8.75	10.61
60	1.98	4.08	6.09	8.72	10.55
65	1.98	4.10	6.11	8.70	10.49
70	1.99	4.12	6.13	8.67	10.43
75	1.99	4.14	6.15	8.64	10.38
80	2.00	4.16	6.18	8.62	10.33
85	2.00	4.18	6.21	8.60	10.28
90	2.00	4.21	6.24	8.58	10.23
95	2.00	4.24	6.27	8.56	10.18

Buffer Table, HACH

Nominal values: 4.01 7.00 10.01(± 0.02 at 25 °F)

°C	pH		
0	4.00	7.118	10.30
5	4.00	7.087	10.23
10	4.00	7.059	10.17
15	4.00	7.036	10.11
20	4.00	7.016	10.05
25	4.01	7.00	10.00
30	4.01	6.987	9.96
35	4.02	6.977	9.92
40	4.03	6.97	9.88
45	4.05	6.965	9.85
50	4.06	6.964	9.82
55	4.07	6.965	9.79
60	4.09	6.968	9.76
65	4.10	6.98	9.71
70	4.12	7.00	9.66
75	4.14	7.02	9.63
80	4.16	7.04	9.59
85	4.18	7.06	9.56
90	4.21	7.09	9.52
95	4.24	7.12	9.48

Buffer Table, Ciba (94)

Nominal values: 2.064.00 7.00 10.00

°C	pH			
0	2.04	4.00	7.10	10.30
5	2.09	4.02	7.08	10.21
10	2.07	4.00	7.05	10.14
15	2.08	4.00	7.02	10.06
20	2.09	4.01	6.98	9.99
25	2.08	4.02	6.98	9.95
30	2.06	4.00	6.96	9.89
35	2.06	4.01	6.95	9.85
40	2.07	4.02	6.94	9.81
45	2.06	4.03	6.93	9.77
50	2.06	4.04	6.93	9.73
55	2.05	4.05	6.91	9.68
60	2.08	4.10	6.93	9.66
65	2.07 ¹⁾	4.10 ¹⁾	6.92 ¹⁾	9.61 ¹⁾
70	2.07	4.11	6.92	9.57
75	2.04 ¹⁾	4.13 ¹⁾	6.92 ¹⁾	9.54 ¹⁾
80	2.02	4.15	6.93	9.52
85	2.03 ¹⁾	4.17 ¹⁾	6.95 ¹⁾	9.47 ¹⁾
90	2.04	4.20	6.97	9.43
95	2.05 ¹⁾	4.22 ¹⁾	6.99 ¹⁾	9.38 ¹⁾

Buffer Table, WTW Technical Buffers

Nominal values in bold.

°C	pH			
0	2.03	4.01	7.12	10.65
5	2.02	4.01	7.09	10.52
10	2.01	4.00	7.06	10.39
15	2.00	4.00	7.04	10.26
20	2.00	4.00	7.02	10.13
25	2.00	4.01	7.00	10.00
30	1.99	4.01	6.99	9.87
35	1.99	4.02	6.98	9.74
40	1.98	4.03	6.97	9.61
45	1.98	4.04	6.97	9.48
50	1.98	4.06	6.97	9.35
55	1.98	4.08	6.98	
60	1.98	4.10	6.98	
65	1.99	4.13	6.99	
70	2.00	4.16	7.00	
75	2.00	4.19	7.02	
80	2.00	4.22	7.04	
85	2.00	4.26	7.06	
90	2.00	4.30	7.09	
95	2.00	4.35	7.12	

1) extrapolated

Buffer Table, Reagecon

Nominal values in bold.

°C	pH				
0	2.01 ¹⁾	4.01 ¹⁾	7.07 ¹⁾	9.18 ¹⁾	12.54 ¹⁾
5	2.01 ¹⁾	4.01 ¹⁾	7.07 ¹⁾	9.18 ¹⁾	12.54 ¹⁾
10	2.01	4.00	7.07	9.18	12.54
15	2.01	4.00	7.04	9.12	12.36
20	2.01	4.00	7.02	9.06	12.17
25	2.00	4.00	7.00	9.00	12.00
30	1.99	4.01	6.99	8.95	11.81
35	2.00	4.02	6.98	8.90	11.63
40	2.01	4.03	6.97	8.86	11.47
45	2.01	4.04	6.97	8.83	11.39
50	2.00	4.05	6.96	8.79	11.30
55	2.00	4.07	6.96	8.77	11.13
60	2.00	4.08	6.96	8.74	10.95
65	2.00 ¹⁾	4.10 ¹⁾	6.99 ¹⁾	8.70 ¹⁾	10.95 ¹⁾
70	2.00 ¹⁾	4.12 ¹⁾	7.00 ¹⁾	8.67 ¹⁾	10.95 ¹⁾
75	2.00 ¹⁾	4.14 ¹⁾	7.02 ¹⁾	8.64 ¹⁾	10.95 ¹⁾
80	2.00 ¹⁾	4.16 ¹⁾	7.04 ¹⁾	8.62 ¹⁾	10.95 ¹⁾
85	2.00 ¹⁾	4.18 ¹⁾	7.06 ¹⁾	8.60 ¹⁾	10.95 ¹⁾
90	2.00 ¹⁾	4.21 ¹⁾	7.09 ¹⁾	8.58 ¹⁾	10.95 ¹⁾
95	2.00 ¹⁾	4.24 ¹⁾	7.12 ¹⁾	8.56 ¹⁾	10.95 ¹⁾

¹⁾ values added

14.3 Calibration Solutions

Potassium Chloride Solutions

(Conductivity in mS/cm)

Temperature [°C]	Concentration ¹⁾		
	0.01 mol/l	0.1 mol/l	1 mol/l
0	0.776	7.15	65.41
5	0.896	8.22	74.14
10	1.020	9.33	83.19
15	1.147	10.48	92.52
16	1.173	10.72	94.41
17	1.199	10.95	96.31
18	1.225	11.19	98.22
19	1.251	11.43	100.14
20	1.278	11.67	102.07
21	1.305	11.91	104.00
22	1.332	12.15	105.94
23	1.359	12.39	107.89
24	1.386	12.64	109.84
25	1.413	12.88	111.8
26	1.441	13.13	113.77
27	1.468	13.37	115.74
28	1.496	13.62	
29	1.524	13.87	
30	1.552	14.12	
31	1.581	14.37	
32	1.609	14.62	
33	1.638	14.88	
34	1.667	15.13	
35	1.696	15.39	
36		15.64	

¹⁾ Data source: K. H. Hellwege (Editor), H. Landolt, R. Börnstein: Zahlenwerte und Funktionen ..., volume 2, part. volume 6

Sodium Chloride Solutions

(Conductivity in mS/cm)

Temperature [°C]	Concentration		
	0.01 mol/l ¹⁾	0.1 mol/l ¹⁾	1 mol/l ²⁾
0	0.631	5.786	134.5
1	0.651	5.965	138.6
2	0.671	6.145	142.7
3	0.692	6.327	146.9
4	0.712	6.510	151.2
5	0.733	6.695	155.5
6	0.754	6.881	159.9
7	0.775	7.068	164.3
8	0.796	7.257	168.8
9	0.818	7.447	173.4
10	0.839	7.638	177.9
11	0.861	7.831	182.6
12	0.883	8.025	187.2
13	0.905	8.221	191.9
14	0.927	8.418	196.7
15	0.950	8.617	201.5
16	0.972	8.816	206.3
17	0.995	9.018	211.2
18	1.018	9.221	216.1
19	1.041	9.425	221.0
20	1.064	9.631	226.0
21	1.087	9.838	231.0
22	1.111	10.047	236.1
23	1.135	10.258	241.1
24	1.159	10.469	246.2
25	1.183	10.683	251.3
26	1.207	10.898	256.5
27	1.232	11.114	261.6
28	1.256	11.332	266.9
29	1.281	11.552	272.1
30	1.306	11.773	277.4
31	1.331	11.995	282.7
32	1.357	12.220	288.0
33	1.382	12.445	293.3
34	1.408	12.673	298.7
35	1.434	12.902	304.1
36	1.460	13.132	309.5

¹⁾ Data source: K. H. Hellwege (Editor), H. Landolt, R. Börnstein: Zahlenwerte und Funktionen ..., volume 2, part. volume 6

²⁾ Data source: Test solutions calculated according to DIN IEC 746-3

14.4 TAN Options

The functions described below are available after enabling their TAN options.

→ *Option Activation, p. 49*

14.4.1 pH Buffer Table: Entry of Individual Buffer Set (FW-E002)

The FW-E002 add-on function must be activated in the device with a TAN for the specifiable buffer table. → *Option Activation, p. 49*

You can enter an individual buffer set with 3 buffer solutions. To do so, enter the nominal buffer values for the correct temperature (0 ... 95 °C / 32 ... 203 °F, 5 °C/9 °F step size). Then this buffer set is available as "Table" in addition to the permanently set standard buffer solutions.

Conditions for the Specifiable Buffer Set:

- All values must lie in the range pH 0 ... 14.
- Maximum difference between two adjacent pH values (5 °C step width) of the same buffer solution: 0.25 pH units.
- The values of buffer solution 1 must be lower than those of buffer solution 2.
- The difference between values for identical temperatures must be greater than 2 pH units. An error message appears if your input is incorrect.

The pH value at 25 °C/77 °F is always used for buffer display during calibration.

Settings can be changed in the **Buffer Table** submenu:

Parameter Setting ▶ **System Control** ▶ **Buffer Table**

01. Select buffer to be entered. Enter the values for 3 complete buffer solutions in ascending order (e.g., pH 4, 7, 10). Minimum distance: 2 pH units.
02. Enter the nominal buffer value and all temperature-corrected buffer values and press **enter** to confirm.

The individual buffer set is selected in the menu:

Parameter Setting ▶ **[I] [II] ... pH** ▶ **Cal Presettings**

Calibration Mode : Calimatic

Buffer Set : Table

Buffer set:

Fill in your configuration data or use the table as original for copy.

Temperature (°C)	Buffer 1	Buffer 2
5		
10		
15		
20		
25		
30		
35		
40		
45		
50		
55		
60		
65		
70		
75		
80		
85		
90		
95		

14.4.2 Current Characteristic (FW-E006)

The FW-E006 add-on function must be activated in the device with a TAN for the specifiable current characteristic. → *Option Activation, p. 49*

Assignment of output current to process variables in 1-mA increments.

Settings can be changed in:

Parameter Setting ▶ Inputs/Outputs ▶ Current Outputs

01. Open the Current Output I1 or Current Output I2 submenus.

02. Usage : On

03. Select the Process Variable .

04. Characteristic : Table

✓ The Table submenu is displayed.

05. Open the Table submenu.

06. Enter process variable values.

The entered values must be continuously rising or falling.

14.4.3 Concentration Determination (FW-E009)

The FW-E009 add-on function must be activated in the device with a TAN for the concentration determination. → *Option Activation, p. 49*

The substance concentration in percent by weight (wt%) is determined for H₂SO₄, HNO₃, HCl, NaOH, NaCl, and Oleum.

Conditions for Concentration Determination

The following pages present the conductivity curves depending on substance concentration and medium temperature.

The following conditions must be met for a reliable concentration determination:

- For calculation of concentration, the medium to be measured must be a purely binary mixture (e.g., water-hydrochloric acid). Presence of other dissolved substances (e.g., salts) leads to incorrect concentration values.
- In the region of small slopes (e.g., at the range limits) small changes in conductivity can correspond to large changes in concentration. This may lead to an unsteady display of the concentration value.
- As the concentration value is calculated from the measured conductivity and temperature values, accurate temperature measurement is very important. Therefore, you should make sure that conductivity sensor and process medium are in thermal equilibrium.

Settings can be changed in the Concentration submenu:

Parameter Setting ▶ [I] [II] ... Cond(I) ▶ Concentration

01. Concentration : On

02. Select the medium :

NaCl (0-28 %), HCl (0-18 %), NaOH (0-24 %), H₂SO₄ (0-37 %), HNO₃ (0-30 %), H₂SO₄ (89-99 %), HCl (22-39 %), HNO₃ (35-96 %), H₂SO₄ (28-88 %), NaOH (15-50 %), Oleum (12-45 %), table

You can define limits for warning and failure messages for the concentration value:

Parameter Setting ▶ [I] [II] ... Cond(I) ▶ Messages ▶ Concentration Messages → *Messages, p. 86*

Specifying a Concentration Solution for Conductivity Measurement

To specify the customer-specific solution, 5 concentration values A-E are entered in a matrix together with 5 temperature values 1-5. First enter the 5 temperature values, then the corresponding conductivity values for each of the concentrations A-E.

These solutions are then available as "Table" in addition to the permanently set standard solutions.

Settings can be changed in the **System Control** in the **Concentration Table** submenu:

Parameter Setting ▶ System Control ▶ Concentration Table

01. Enter temperatures 1 to 5.

02. Enter values for concentrations A-E for the respective temperatures.

Note: The temperature values must be rising (Temp. 1 is the lowest, Temp. 5 the highest temperature). The concentration values must be rising (Conc. A is the lowest, conc. E the highest concentration). The table values A1 ... E1, A2 ... E2, etc. must all be rising within the table or all falling. Points of inflection are not allowed.

Incorrect table entries are indicated by an exclamation point in a red triangle.

The table is built up as 5x5 matrix:

	Conc. A	Conc. B	Conc. C	Conc. D	Conc. E
Temp. 1	A1	B1	C1	D1	E1
Temp. 2	A2	B2	C2	D2	E2
Temp. 3	A3	B3	C3	D3	E3
Temp. 4	A4	B4	C4	D4	E4
Temp. 5	A5	B5	C5	D5	E5

The concentration table is selected in the menu:

Parameter Setting ▶ [I] [II] ... Cond(I) ▶ Cal Presettings

Calibration Mode : Automatic

Cal Solution : Table

Concentration Curves

Conductivity [mS/cm] versus substance concentration [wt%] and media temperature [°C]

Sodium Chloride Solution NaCl

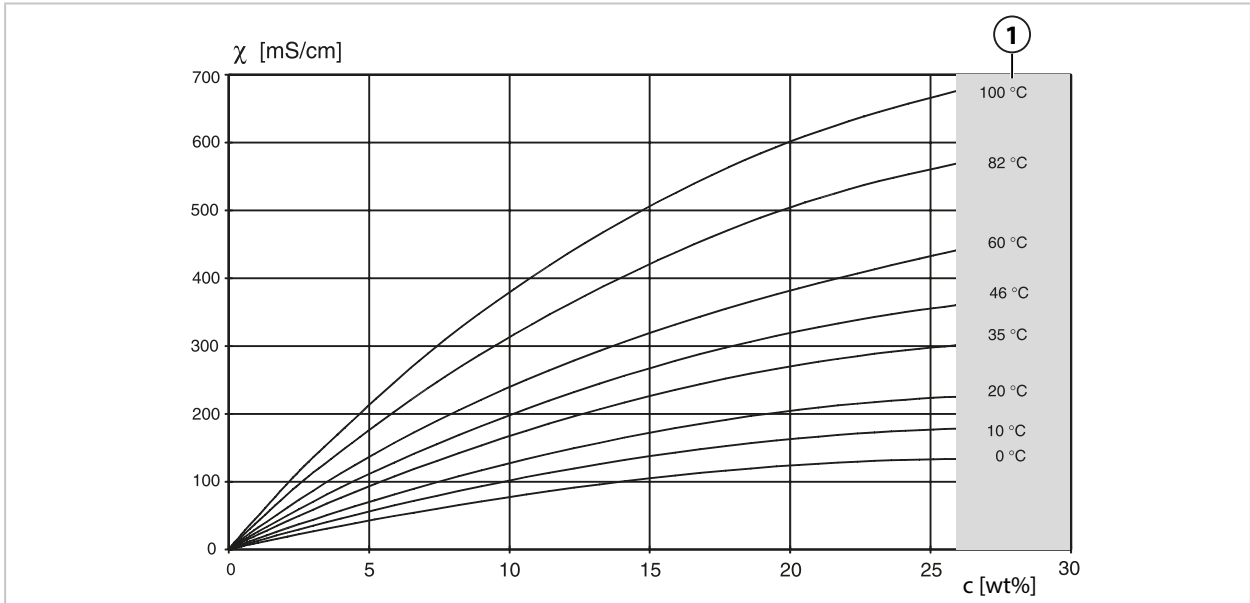

1 Range within which concentration determination is not possible.

Hydrochloric Acid HCl

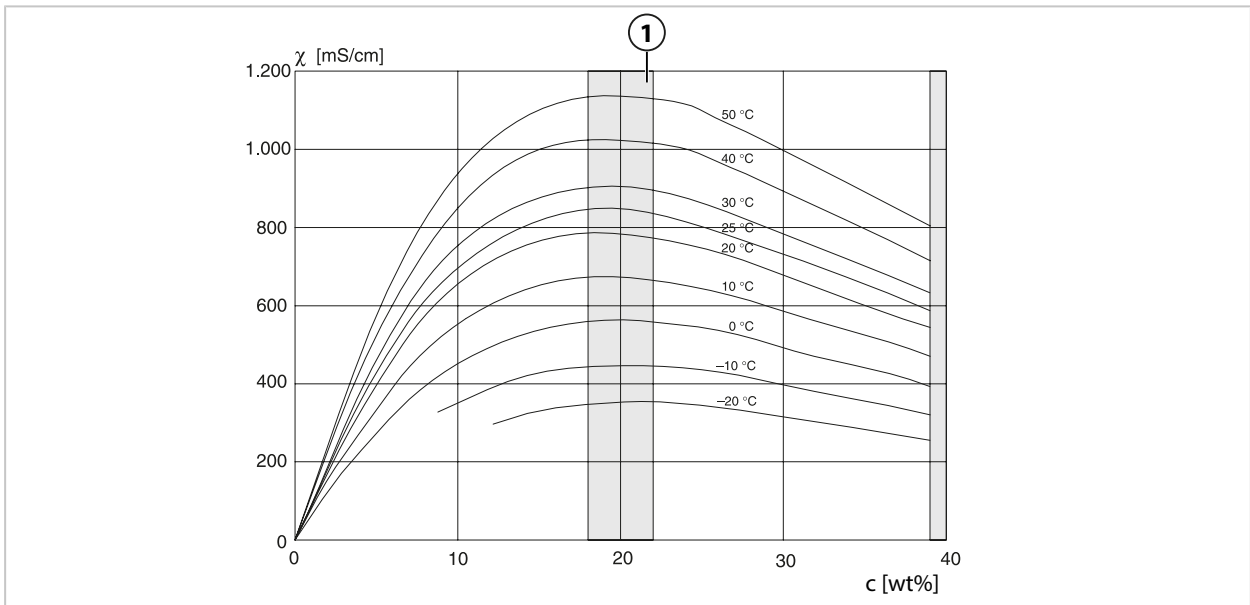

1 Range within which concentration determination is not possible.

Sodium Hydroxide Solution NaOH

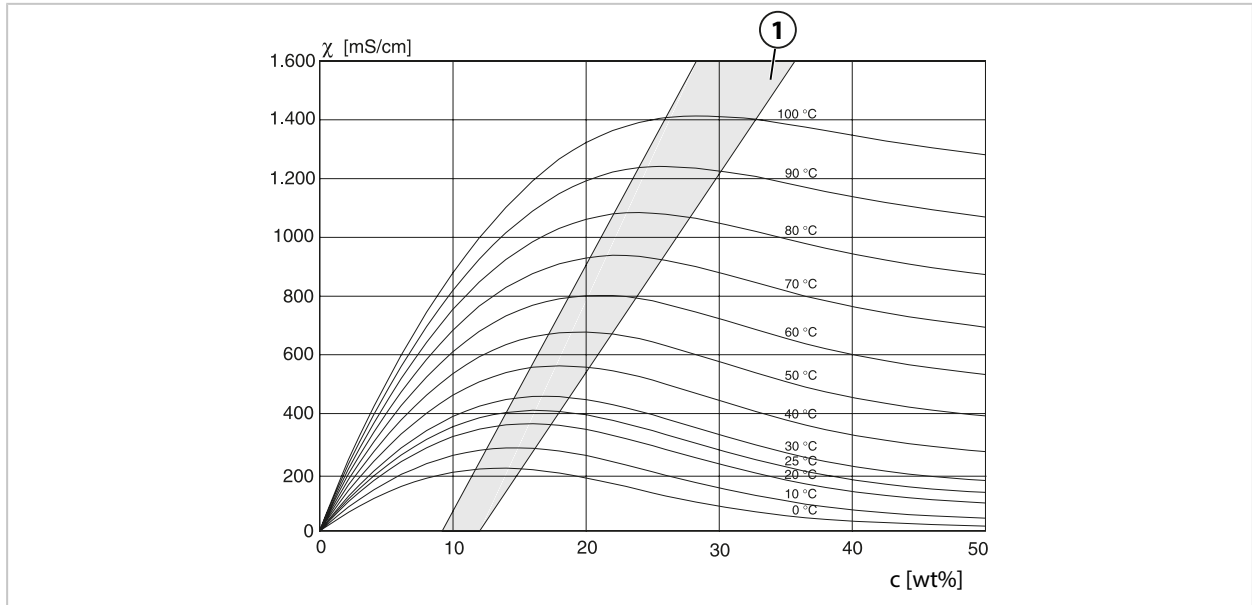

1 Range within which concentration determination is not possible.

Sulfuric Acid H₂SO₄

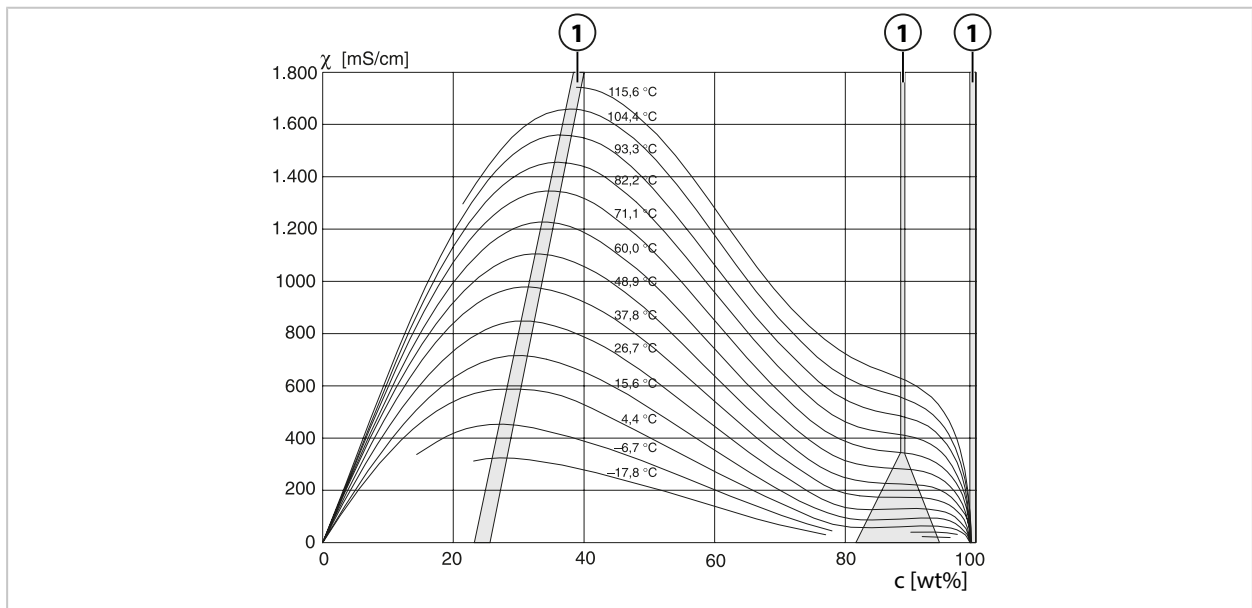

1 Range within which concentration determination is not possible.

Nitric Acid HNO₃

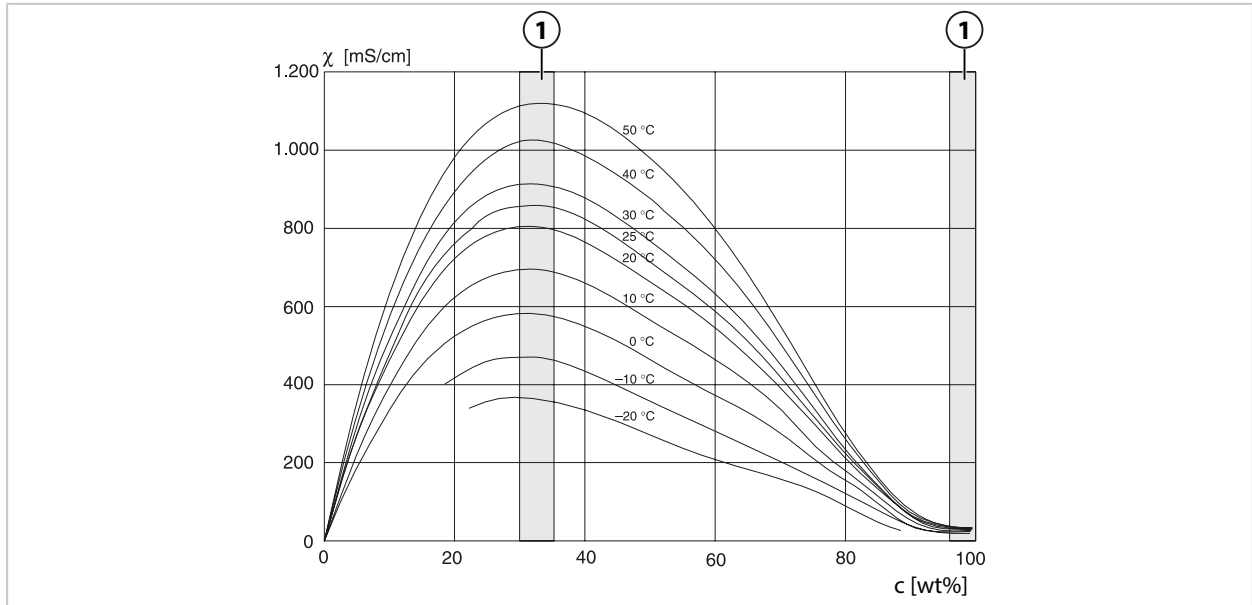

1 Range within which concentration determination is not possible.

Oleum H₂SO₄•SO₃

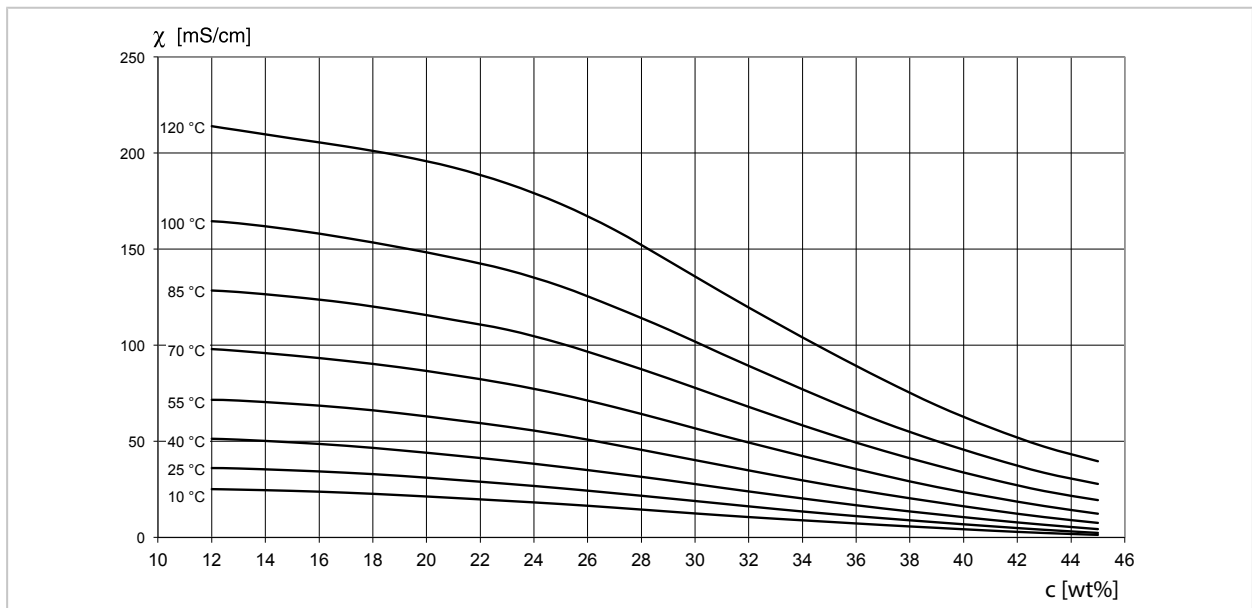

1 Range within which concentration determination is not possible.

14.4.4 Pfaudler Sensors (FW-E017)

This option enables simultaneous pH and temperature measurements using Pfaudler pH sensors or pH sensors with a zero point other than pH 7 and/or a deviating slope, e.g., pH sensors with a zero point at pH 4.6.

The FW-E017 add-on function must be activated in the device with a TAN for this purpose.

→ *Option Activation, p. 49*

Do the following prior to measurement if using analog sensors:

01. Select the used sensor type:

Parameter Setting ▶ [II] Analog pH ▶ Sensor Data → *Sensor Data, p. 70*

02. Enter the nominal zero point and the nominal slope data supplied by the sensor manufacturer.

Parameter Setting ▶ [II] Analog pH ▶ Sensor Data ▶ Sensor Monitoring Details

03. Select parameters.

04. Monitoring: "Individual"

- ✓ The values for "Nominal," "Min.," and "Max." can be entered.
See below for default values if "Auto" is selected.

05. Select "Data Entry" calibration mode:

Calibration ▶ [II] Analog pH → *Calibration Mode: Data Entry, p. 128*

- ✓ The pH_{is} value for the isothermal intersection point can be entered.

06. If required, further calibrations can still be performed. The pH_{is} value entered in "Data Entry" calibration mode remains stored.

Note: When a Pfaudler enamel electrode is connected, the data is read from the sensor or set to the standard values. No menu entries are required; they are therefore deactivated.

The nominal values for zero point and slope are required to ensure that the sensor monitoring and calibration functions (Sensoface, Calimatic) operate as intended. They do not replace the need for calibration.

Presets for Slope, Zero Point, Sensocheck Reference Electrode

Parameter Setting ▶ [II] Analog pH ▶ Sensor Data ▶ Sensor Monitoring Details :

Monitoring: "Auto"

Selected sensor type	Pfaudler Standard	Pfaudler Diff.	Glass El. Diff.
Nom. slope	59.2 mV/pH	59.2 mV/pH	59.2 mV/pH
Nom. zero point	pH 1.50	pH 10.00	pH 7.00
Sensocheck reference electrode	500 kΩ	30 MΩ	120 MΩ

Typical Values

These values are for guidance only. The exact values are supplied by the sensor manufacturer.

Sensor	Pfaudler enamel sensors (Pfaudler specifications)	Sensors with absolute pH measurement and Ag/AgCl reference system	Sensors with absolute pH measurement and Ag/Ac (silver acetate) reference system	Differential pH sensors
Nom. slope	55 mV/pH	55 mV/pH	55 mV/pH	55 mV/pH
Nom. zero point	pH 8.65	pH 8.65	pH 1.35	pH 7 ... 12
pH _{is}	pH 1.35	pH 1.35	pH 1.35	pH 3.00

Note: Refer to the operating instructions for the respective sensor to obtain more information on functioning, installation, calibration, and configuration.

Isothermal Intersection Point

The isothermal intersection point is the intersection of two calibration lines plotted for two different temperatures. The coordinates of this intersection are labeled V_{is} and pH_{is} . The isothermal intersection point remains constant for each sensor.

It may cause temperature-dependent measurement errors, but such errors can be avoided by calibrating at the measuring temperature or at a constant, controlled temperature.

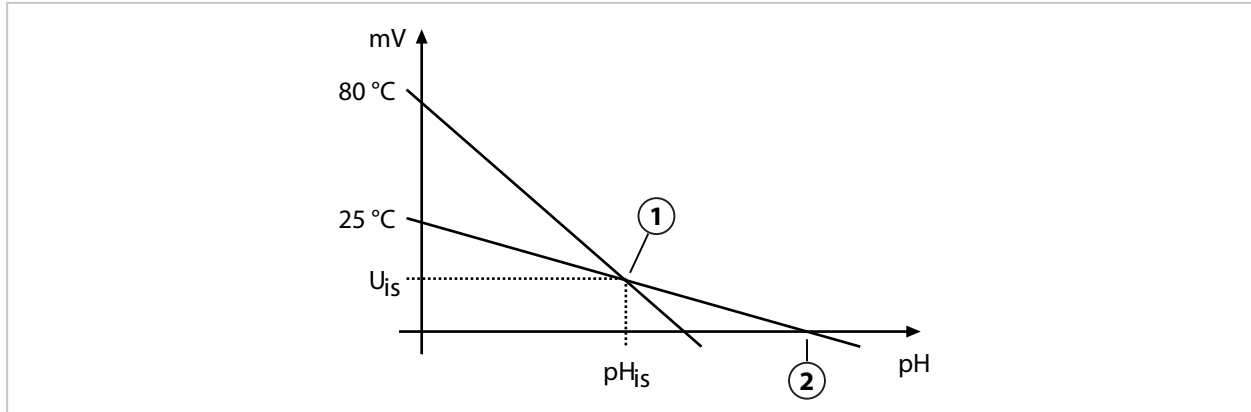

1 Isothermal intersection point

2 Zero point

14.4.5 Calculation Blocks (FW-E020)

After activating TAN option FW-E020, two calculation blocks that can convert existing process variables to new variables are available. → *Option Activation, p. 49*

In addition, the general device status (NAMUR signals) is taken into account.

The following variables are calculated from the existing values:

- Measured value difference (selection depending on sensor)
- Ratio
- Passage
- Rejection
- Deviation
- pH value calculation from dual conductivity measurement (see below)
- User-Spec (DAC): User specification

All new variables generated by the calculation blocks can be output at the current outputs and on the measurement display.

Activating and Configuring Calculation Blocks

Parameter Setting ▶ System Control ▶ Calculation Blocks

Requirements

- At least two sensors are connected.
- TAN option FW-E020 is enabled.

Steps

01. Open Calculation Blocks.
02. Select a process variable combination.

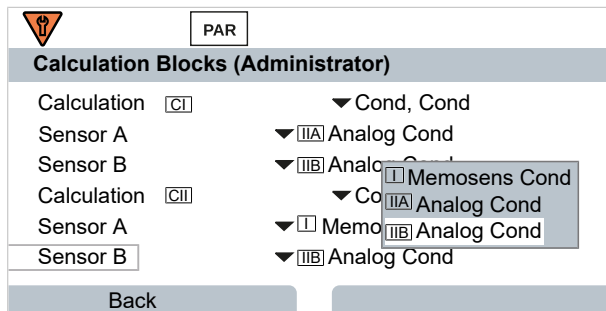

03. 2x **left softkey: Back**
04. Scroll down using the **arrow key** and select a calculation block.

During parameter setting, the calculation blocks are displayed like modules, plus [CI] or [CII]:

05. Configure the calculation block.

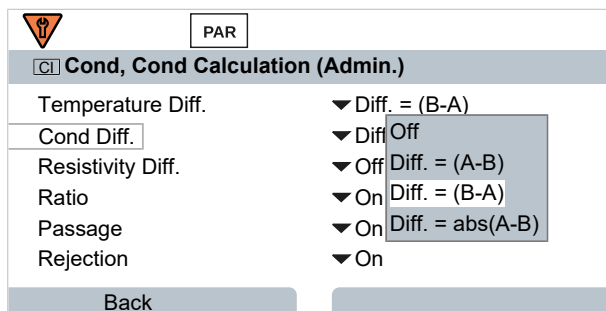

Process Variable Combination in Calculation Block

Process Variable Combinations	Calculation Block	Variables Calculated by Calculation Block	
pH + pH	pH/pH	Temperature difference	°C
		pH value difference	pH
		ORP difference	mV
		pH voltage difference	mV
Cond + Cond Condl + Condl Cond + Condl	Cond/Cond	Temperature difference	°C
		Conductivity difference	S/cm
		Resistivity difference	$\Omega \cdot \text{cm}$
		Ratio	S/cm [%]
		Passage	S/cm [%]
		Rejection	S/cm [%]
		Deviation	S/cm [%]
Oxy + Oxy	Oxy/Oxy	Saturation %air difference	%air
		Saturation %O ₂ difference	%O ₂
		Conc. (liquid) difference	mg/l
		Conc. (gas) difference	%vol
		Temperature difference	°C

Calculation Formulas

Process Variable	Calculation Formula	Range	Span
Difference (selectable in menu)	Diff. = A - B	Process variable	Process variable
	Diff. = B - A		
	Diff. = abs(A - B)		
Ratio (Cond/Cond only)	Cond A/Cond B	0.00 ... 19.99	0.10
Passage (Cond/Cond only)	Cond B/Cond A · 100	0.00 ... 199.9	10 %
Rejection (Cond/Cond only)	(Cond A - Cond B)/Cond A · 100	-199.9 ... 199.9	10 %
Deviation (Cond/Cond only)	(Cond B - Cond A)/Cond A · 100	-199.9 ... 199.9	10 %

When calculating Cond/Cond, it is possible to determine a pH value from the measured conductivity values. Settings can be changed in the **pH Value** submenu:

Adjustable Parameters for pH Value Calculation

Parameter Setting ▶ [C/I/II] Cond/Cond Calculation ▶ pH Value

Usage	Off, pH-VGB-S-006, pH variable
If you select pH-VGB-S-006:	
Alkalizing Agent	NaOH: $11 + \log((\text{COND A} - \text{COND B} / 3) / 243)$ NH ₃ : $11 + \log((\text{COND A} - \text{COND B} / 3) / 273)$ LiOH: $11 + \log((\text{COND A} - \text{COND B} / 3) / 228)$
Alkalizing	Off, on
Ion Exchanger	Off, on
Filter Volume	Enter filter volume in l
Resin Capacity	Enter resin capacity
Capacity Factor	Enter capacity factor in %
If you select pH variable:	
Enter coefficient C, factor 1 ... 3	

Typical Application

pH Value Calculation by Means of Dual Conductivity Measurement

When monitoring boiler feedwater in power plants, dual conductivity measurement can be used to calculate the pH value. For that purpose, the boiler feedwater conductance is measured upstream and downstream of the cation exchanger. This commonly used method of indirect pH value measurement does not require much maintenance and has the following advantage:

Normal pH measurement in ultrapure water is very critical. Boiler feedwater does not contain many ions. This requires the use of a special electrode, which must be calibrated constantly and has a generally short life.

Two sensors are used to measure the conductivity upstream and downstream of the cation exchanger. The pH value is inferred from these two conductivity values.

pH Value Measurement of Boiler Feedwater in Power Plant Technology

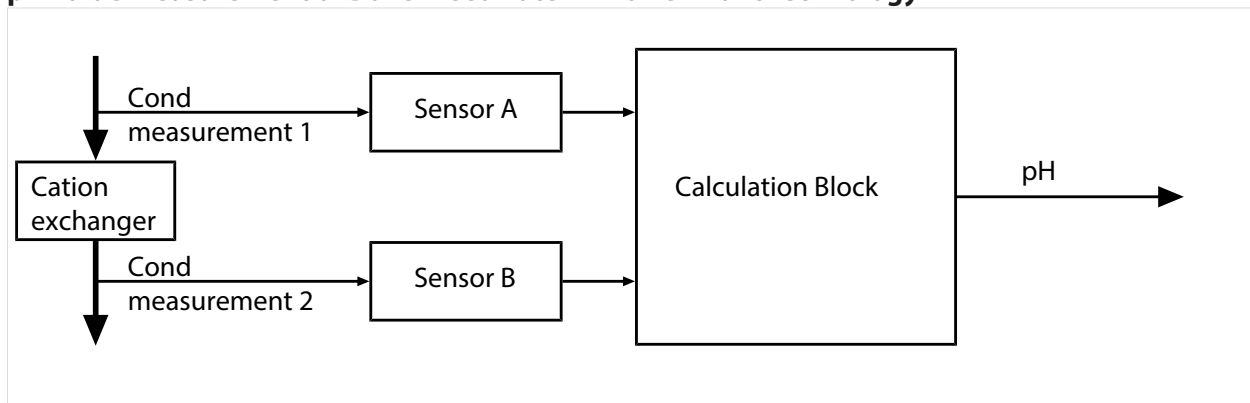

Calculating the concentration of sodium hydroxide / the pH value

$$c(\text{NaOH}) = (\text{Cond1} - \frac{1}{3} \text{Cond2}) / 243$$

$$\text{pH} = 11 + \log[c(\text{NaOH})]$$

Recommended pH ranges:

10 ± 0.2 for < 136 bar operating overpressure or

9.5 ± 0.2 for > 136 bar operating overpressure

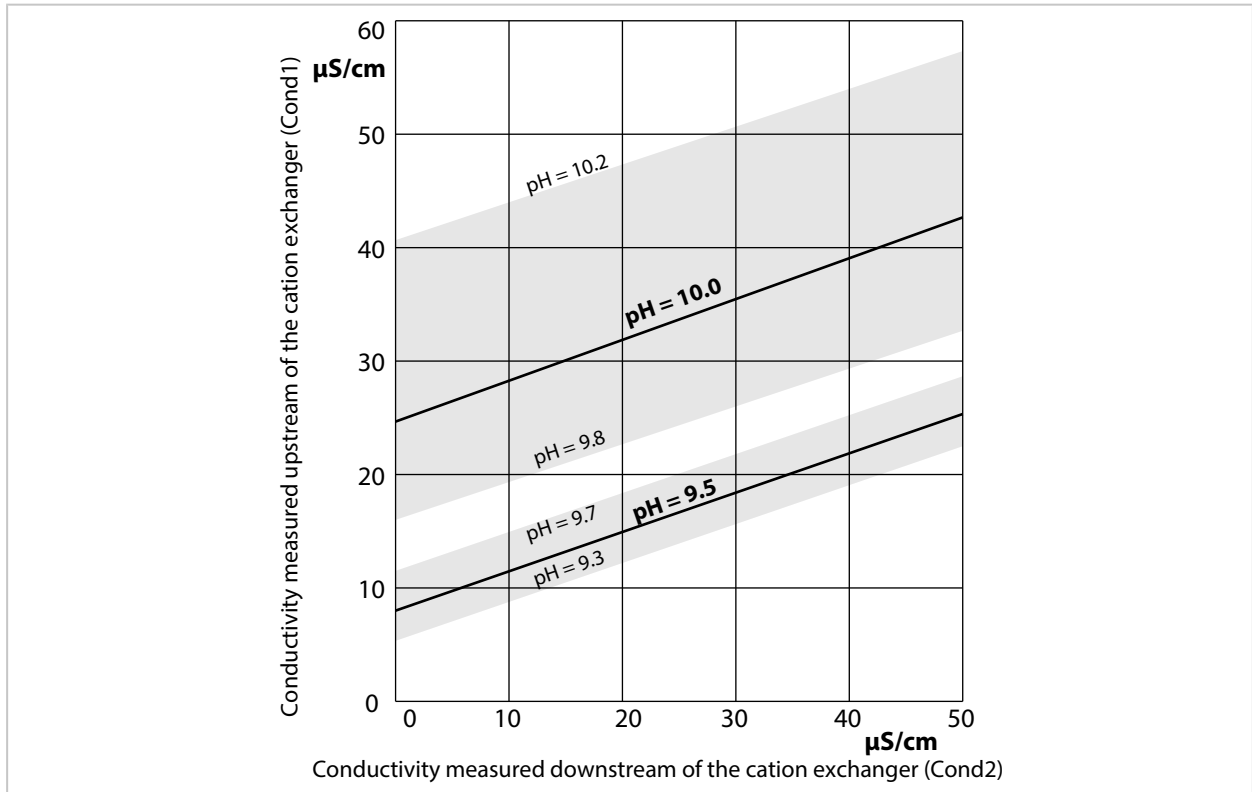

Conditioning of water in natural circulation boilers with sodium hydroxide. Relationship between the pH value and the conductivity measured upstream and downstream of the cation exchanger.

Source: Appendix to VGB guideline for boiler feed water, boiler water, and steam of steam generators above 68 bar permissible operating overpressure (VGB- R 450 L, 1988 edition)

See also

→ *Dual Conductivity Measurement, p. 95*

14.4.6 Digital ISM Sensors (FW-E053)

This option enables the use of digital ISM sensors to measure pH, ORP, and oxygen (amperometric). The FW-E053 add-on function must be activated in the device with a TAN for this purpose.

→ *Option Activation, p. 49*

Identifying an ISM Sensor

ISM sensors have an “electronic datasheet”. The permanent factory data (manufacturer, sensor description) and key sensor-related parameters are automatically transferred to the Stratos Multi.

Sensor Monitoring



Predictive maintenance data can be entered into the sensor by the device. This includes, for example, the maximum permitted number of CIP/SIP or autoclaving cycles. The settings can be changed in Parameter Setting:

Parameter Setting ▶ [II] ISM [pH] ▶ Sensor Data ▶ Sensor Monitoring Details → *pH Process Variable, p. 68*

Parameter Setting ▶ [II] ISM [Oxy] ▶ Sensor Data ▶ Sensor Monitoring Details

→ *Oxygen Process Variable, p. 97*

You can select whether and how an exceeded limit value is to be displayed for each parameter:

Off	No message, but the parameter is still shown in the Diagnostics menu.
Failure	A Failure message is shown in off-limit conditions; the corresponding NAMUR icon  is displayed. If “Display Color NE107” is selected, the measurement display is shown with red backlighting.
Maintenance	A Maintenance Required message is shown in off-limit conditions; the corresponding NAMUR icon  is displayed. If “Display Color NE107” is selected, the measurement display is shown with blue backlighting.

Calibration/Adjustment

Note: The calibration data is saved in the ISM sensor. This means that ISM sensors can be cleaned, reconditioned, calibrated, and adjusted away from the measurement location, e.g., in a laboratory. Sensors in the system are replaced on-site by adjusted sensors.

An ISM sensor that has never been used before must first be calibrated:

01. Calibration ▶ [II] ISM [pH/Oxy]
02. Select Calibration Mode .
03. First Adjustment : Yes
04. Adjust other settings available in the calibration mode.
 - ✓ Calibration can be performed. → *Calibration/Adjustment, p. 121*

14.4.7 Parameter Sets 1-5 (FW-E102)

The FW-E102 add-on function must be activated in the device with a TAN for use of parameter sets 1-5.
→ *Option Activation, p. 49*

Saving a Parameter Set on the Data Card

2 complete parameter sets (A, B) are stored in the device. Up to 5 parameter sets can be loaded to the Data Card. To do so, a parameter set (1, 2, 3, 4, or 5) on the Data Card is overwritten by the device-internal parameter set A:

Parameter Setting ▶ System Control ▶ Parameter Sets ▶ Save Parameter Set

01. **Save to** : Select the parameter set to be overwritten.

✓ The parameter set is saved as a file on the Data Card.

Loading a Parameter Set from the Data Card

A parameter set saved on the Data Card (1, 2, 3, 4, or 5) can be loaded to the device-internal parameter set A. This overwrites parameter set A:

Parameter Setting ▶ System Control ▶ Parameter Sets ▶ Load Parameter Set

01. **Load from** : Select the parameter set to be loaded.

✓ The parameter set is saved as parameter set A in the device.

14.4.8 Measurement Recorder (FW-E103)

The FW-E103 add-on function must be activated in the device with a TAN for use of the measurement recorder. → *Option Activation, p. 49*

The measurement recorder logs measured values and additional values depending on its parameter setting.

Parameter settings can be made for:

- Process variables to be displayed
- Start and end value for the process variable to be recorded
- Time base (recording interval, selectable from 10 s to 10 h)

In addition, the time axis can be stretched by factor 10 using the “zoom” function.

Setting the Measurement Recorder Parameters:

Parameter Setting ▶ General ▶ Measurement Recorder

Recording starts as soon as the parameters have been set.

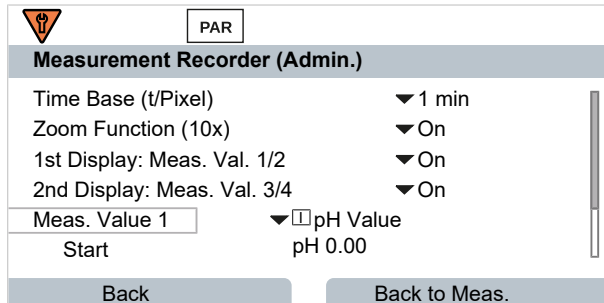

Displaying the Measurement Recorder Data:

Diagnostics ▶ Measurement Recorder

The measurement recorder saves all entries in a file. The last 100 entries are graphically presented on the device’s display.

Up to 4 process variables are displayed. These 4 process variables are distributed to 2 measurement recorders. Use the right *softkey* to toggle between the measurement recorders.

The zoom function is automatically switched on for fast changes. It begins several pixels before the event. This makes process variable fluctuation traceable in detail.

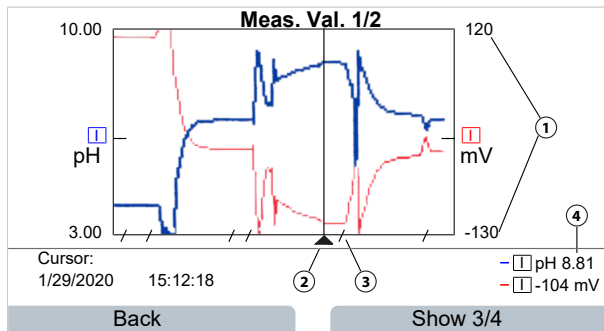

- | | |
|---|---|
| <p>1 Graphic range
Start and end value of the process variable</p> <p>2 Cursor
(shift using arrow keys)</p> | <p>3 Ranges with fast measured value changes
(automatic zoom function) are marked by lines.</p> <p>4 Currently measured values at cursor position</p> |
|---|---|

Deleting the Measurement Recorder’s Data:

Parameter Setting ▶ System Control ▶ Measurement Recorder

Saving to Data Card

Note: The device’s internal memory has limited capacity and continuously overwrites the oldest data set after reaching maximum memory capacity. For recording sessions that take a long time, a data card is absolutely necessary. The data saved on the data card can be read out and evaluated using a computer.

Enable the Data Card to save recorder data:

Parameter Setting ▶ System Control ▶ Memory Card

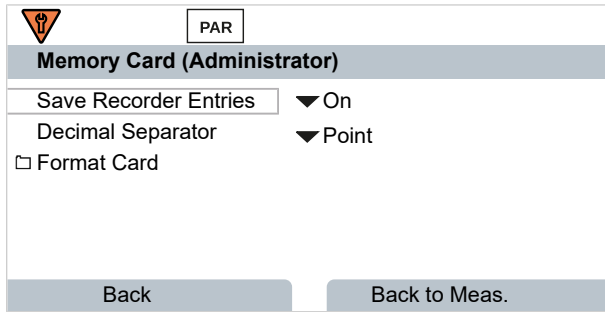

A new file is generated for each day. The date is encoded in the file name.

Example for a file generated on the Data Card:

\RECORDER\R_YYMMDD.TXT

Recorder data of YYMMDD (YY = year, MM = month, DD = day)

The data is recorded as ASCII file with the extension .TXT. The individual columns are separated by tabs. This makes the file readable with word processing or spreadsheet programs (e.g., Microsoft Excel). Each time the Data Card is inserted in the memory card slot, a “Device Info” consisting of the device type, serial number, and tag number is written. Thus, a Data Card can also be used to collect the measurement recorder data of several devices.

Meaning of the entries in the recorder file:

TIME STAMP	Recorder entry time stamp
CH1/2/3/4	1st/2nd/3rd/4th recorder channel with measured value and unit of measurement
Z1/2	1st/2nd additional value and unit of measurement
MAINT	NAMUR signal “Maintenance Required”
HOLD	NAMUR signal “Function Check/HOLD”
FAIL	NAMUR signal “Failure”

14.4.9 Firmware Update (FW-E106)

Note: First check whether your device really requires a firmware update.

The FW-E106 add-on function must be activated in the device with a TAN for the firmware update.

→ *Option Activation, p. 49*

Stratos Multi features a standard microcontroller and a microcontroller for communication. The firmware of both microcontrollers can be updated. The firmware files are named as follows:

- Standard microcontroller:
Firmware: xx.xx.xx. Build xxxxx
- Communication microcontroller:
BASE Firmware (APP): xx.xx.xx. Build xxxxx
BASE Firmware(COM): xx.xx.xx

NOTICE! For a correct firmware update, adhere to the order:

1. Firmware, 2. BASE Firmware (APP), 3. BASE Firmware (COM)

NOTICE! The device is not operable during a firmware update. Its outputs are in an undefined state. After a firmware update, the configuration must be checked.

Note: Before updating the firmware for the standard microcontroller, we recommend saving the previous version on the FW Update Card.

Firmware Update with FW Update Card

⚠ WARNING! Shock potential. When opening the device, there may be dangerous touch voltages in the terminal compartment. Professional installation guarantees direct contact protection. The memory card can be replaced during operation. When doing so, maintain sufficient distance from the mains connection cables and do not use tools.

01. Open the housing.
02. Insert the FW Update Card into the memory card slot in the front unit. → *Memory Card, p. 182*
 - ✓ The FW Update Card icon appears on the display .
03. Close the housing.
04. If required, save the firmware (FW) currently installed on the device:
 - Menu Selection ▶ Parameter Setting ▶ System Control ▶ Firmware Update ▶ Save Firmware
 - Start the backup by pressing the **right softkey: Start**.
 - ✓ When the backup has finished, the device returns to measuring mode.
05. Load the firmware update:
 - Menu Selection ▶ Parameter Setting ▶ System Control ▶ Firmware Update ▶ Update Firmware
06. Select the correct version using the arrow keys:
Firmware, BASE Firmware (APP), BASE Firmware (COM)
07. Confirm with **enter**.
08. Start the firmware update with the **right softkey: Start**.
 - ✓ The firmware update runs.
09. Restart the device by pressing the **right softkey: Restart**.
10. Run BASE Firmware (APP) update (procedure as from step 05 on).
11. Run BASE Firmware(COM) update (procedure as from step 05 on).
12. When the updates have finished, open the housing and remove the FW Update Card.
13. Close and screw the housing together.
14. Check the configuration.

15 PROFINET Technology

PROFINET is an open industrial standard for safe and fast data transmission via the industrial Ethernet. The standard was created and is managed by the PROFIBUS user organization PROFIBUS and PROFINET International (PI).

The PROFINET standard evolved from PROFIBUS – a fieldbus communication standard to support automation technology.

PROFINET ensures correct and timely data transmission, even in demanding applications. In addition to cyclic user data exchange, PROFINET also offers additional functions for transmitting diagnostics, parameter settings, and alarms.

Conformance Classes

To address different requirements, there are four conformance classes (CC-A, CC-B, CC-C, CC-D), which build upon each other and feature a set of functions tailored to typical application areas.

Stratos Multi E461N meets the requirements for class B (CC-B). This means that the devices and the network infrastructure are certified products and structured according to PROFINET IO guidelines.

Note: The firmware version listed on the certificate corresponds to the BASE firmware.

Basic functions in class B:

- RT communication
- Cyclic I/O data transfer
- Parameter
- Alarms
- Network diagnostics
- Topology information

Topology

PROFINET devices can be networked in different ways. A distinction is made between linear, tree, ring, and star topologies.

Stratos Multi E461N can be connected in a ring or star topology.

Ring Topology

In this topology, terminal devices and control systems are connected in series. In addition, the first and last devices are connected to the control system, thereby forming a ring. The ring topology is redundant and therefore recommended for production environments that require a high level of availability.

Two Ethernet sockets are required for this topology.

Star Topology

A star topology uses a central hub that is connected to all the terminal devices. There is no direct connection between the separate terminal devices.

16 Abbreviations

A/F	Width across flats
AI	Analog input
AO	Analog output
CAT	Category
CC-A/B/C/D	Conformance classes
CIP	Cleaning in place
D	Diagnostics
DCP	Discovery and basic configuration protocol
DO	Digital output
EMC	Electromagnetic compatibility
ESD	Electrostatic discharge
FW	Firmware
GSD	Generic station description (device master file)
GSDML	GSD markup language
I&M	Identification and maintenance
I/O, IO	Input/output
ISFET	Ion-sensitive field-effect transistor
ISM	Intelligent sensor management
LDO	Luminescent dissolved oxygen
MAC	Media access control
MD	Maintenance demanded
MR	Maintenance required
PCS	Process control system
PELV	Protective extra low voltage
PROFINET	Process field network
QD	Qualified diagnosis
RD	Received data
RJ45	Registered jack
RT	Real time
SELV	Safety extra low voltage
SIP	Sterilization in place
TAN	Transaction number
TC	Temperature compensation/coefficient
TD	Transmitted data
TDS	Total dissolved solids
TFT	Thin film transistor
TIA	Totally Integrated Automation

Index

2-channel conductivity measurement 95

A

Abbreviations	254
Access control	41
Change passcodes	50
Accessories	182
Adapter cable RJ45/M12 A type ZU1166	188
Adapter cable RJ45/M12 D-type ZU1073	186
Adaptive calibration timer	73
Add-on function	
Activate	49
Descriptions	235
Overview	13
Adjustment of temperature probe	129, 132, 138, 145, 151
Adjustment record	156
Adjustment, definition	121
Administrator level	43
Analog 2-channel conductivity measurement	95
Analog Cond sensor	
Calibration/Adjustment	133
Parameter setting	81
Wiring examples	210
Analog CondI sensor	
Calibration/Adjustment	139
Parameter setting	88
Wiring examples	217
Analog ORP sensor	
Calibration/Adjustment	130
Parameter setting	76
Wiring example	208
Analog oxygen sensor	
Calibration/Adjustment	146
Parameter setting	98
Wiring examples	222
Analog pH sensor	
Calibration/Adjustment	122
Parameter setting	68
Wiring examples	202
Autoclaving counter	
Increment	159
Oxy parameter setting	101
pH parameter setting	72
Automatic calibration/adjustment	
Calimatic pH	124
Cond	134
CondI	140
Oxygen, in air	147
Oxygen, in water	148

B

Bilinear curve	59
Blanking plug for cable gland	25
Boiler feed water	246
Buffer table, specifiable (FW-E002)	235
Buffer tables	225

C

Cable gland, sealing inserts	25
Cal presets	
Cond parameter setting	84
CondI parameter setting	91
ORP parameter setting	78
Oxy parameter setting	102
pH parameter setting	73
Calculation blocks (FW-E020)	244
Calibration record	156
Calibration solutions	233
Calibration timer	
ORP parameter setting	78
Oxy parameter setting	102
pH parameter setting	73
Calibration/Adjustment	
Calibration solutions	233
Cond	133
Cond presets	84
CondI	139
CondI presets	91
General	121
Memosens	122
ORP	130
ORP presets	78
Oxy presets	102
Oxygen	146
pH	122
pH presets	73
Record	156
Calimatic	
Automatic calibration/adjustment	124
Cation exchanger	246
Change signs	38
Changing the device	107
Characteristic curves	58
CIP counter	
Cond parameter setting	83
CondI parameter setting	90
Oxy parameter setting	100
pH parameter setting	71
Commissioning	35
Final check	35
Communication status	118
Concentration determination (FW-E009)	237
Conductivity (contacting)	
Calibration/Adjustment	133
Parameter setting	80
Wiring examples, analog sensors	210
Conductivity (dual)	
Parameter setting	95
Wiring examples	219
Conductivity (inductive)	
Calibration/Adjustment	139
Parameter setting	87
Wiring examples, analog sensors	217
Configuration	
Operating levels	43
System control	45
Configuration, TIA Portal	105
Conformance classes	253

Control inputs			
Parameter setting		65	
Terminal assignments		27	
Current characteristic (FW-E006)		237	
Current outputs			
Active/passive current outputs		29	
Characteristic curves		58	
Function check (HOLD)		60	
Messages		60	
Output filter		60	
Parameter setting		57	
Span, examples		58	
Current source		160	
Custom FW Update/Repair Card		184	
Cyclic data transfer		108	
D			
Data Card			
Configuration		45	
Description		184	
Open/close memory card		182	
Save device settings		46	
Save/load parameter set		249	
Data entry			
ORP calibration/adjustment		130	
Oxygen calibration/adjustment		149	
Date/time		48	
Decommissioning		181	
Default settings, reset		50	
Delta function		74, 78	
Device diagnostics		155	
Device information		155	
Diagnostic functions			
Calibration/adjustment record		156	
Channel I/II		156	
Device information		155	
Device self-test		155	
Logbook		154	
Meas. point description		156	
Message list		154	
Sensor diagram		156	
Sensor information		156	
Sensor monitor		156	
Sensor wear monitor		157	
Temp. offset log		156	
Diagnostics			
Diagnostic functions		153	
PROFINET		115	
Sensoface		178	
Dimension drawings		20	
Display			
Description		36	
No display		162	
Parameter setting		56	
Display color, parameter setting		56	
Display test		155	
Disposal		11, 181	
Dual conductivity measurement			
Calculation blocks		244	
Parameter setting		95	
pH value calculation		246	
Wiring examples		219	
E			
Electrical installation		26	
Electrolyte replacement, confirm		159	
Enter numbers and text		38	
Environmental damage		9	
Error messages, synoptic tables		161	
Ethernet connection		28	
F			
Failure			
Signaling via relay contact		61	
Favorites menu		152	
Firmware repair		184	
Firmware update		252	
First adjustment		122	
Flow measurement		120	
Formats/units, parameter setting		51	
Function blocks		107	
Function check			
Signaling via relay contact		62	
Function control		48	
FW Repair Card		184	
FW Update Card		184	
G			
GSDML file		104	
H			
Hysteresis		62	
I			
I&M functions		119	
I/O data, coding		108	
Icons			
Overview		39	
Initial commissioning		104	
Input OK1			
Function control		48	
Parameter set selection		47	
Parameter setting		65	
Inputs and outputs			
Active/passive current outputs		29	
Parameter setting		57	
System overview		15	
Installation		18	
Electrical installation		26	
Enclosure		18	
Mounting clearance		21	
Mounting options		18	
Wall mounting		20	
Installation factor, calibration/adjustment		144	
Intended use		9	
Introductory safety chapter		2	
Ion exchanger		246	
IP address			
Display		115	
ISFET zero, calibration/adjustment		129	
ISM oxygen sensor (FW-E053)			
Interior body replacement, confirm		160	
Membrane body replacement, confirm		160	
Parameter setting		97	
Wiring example		224	

ISM pH sensor (FW-E053)			
Parameter setting	68		
Wiring example	209		
ISM sensors (FW-E053), description	248		
Isothermal intersection point	243		
K			
Key lock	115		
Keypad	38		
Keypad test	155		
L			
Language, select	36		
LEDs	118		
Linear characteristic	58		
Lingua	36		
Load matrix	157		
Locking a function	44		
Logarithmic curve	59		
Logbook			
Delete entries	49		
Display entries	154		
Parameter setting	49		
M			
MAC address			
Display	115		
Maintenance	11		
Maintenance functions	158		
Maintenance functions			
Autoclaving counter	159		
Current source	160		
Electrolyte replacement/Membrane body replacement	159		
Relay test	160		
Replacing the membrane body/interior body	160		
Sensor monitor	159		
Maintenance required			
Signaling via relay contact	61		
Malfunction states	161		
Manual calibration/adjustment			
Cond	135		
CondI	141		
pH	126		
Manual function check	160		
Meas. point description			
Display	156		
Parameter setting	48		
Measured value status	116		
Measured values, PROFINET	109		
Measurement display			
General	42		
Parameter setting	51		
Measurement recorder (FW-E103)			
Delete data	49		
Description	250		
Display data	250		
Measuring modules			
Insert	32		
Overview, non-Ex	13		
Terminal assignments	33		
Wiring examples	202		
Membrane body replacement, confirm	159		
Memory card			
Configuration	45		
Insert	182		
Memory card types	184		
Memosens			
Sensor connection	31		
Sensor information	156		
Memosens cond sensor			
Parameter setting	80		
Memosens CondI sensor			
Parameter setting	87		
Memosens conductivity sensor			
Parameter setting	80, 87		
Memosens ORP sensor			
Parameter setting	76		
Memosens oxygen sensor			
Parameter setting	96		
Memosens pH sensor			
Parameter setting	67		
Menu selection	36		
Menu structure	41		
Message list			
Displays	154		
Error messages, overview	161		
Messages			
Conductivity parameter setting	86, 94		
ORP parameter setting	79		
Oxygen parameter setting	103		
pH parameter setting	75		
Monitoring limits			
Conductivity	86, 94		
ORP	79		
Oxygen	103		
pH, pH/ORP	75		
Multiple sealing insert for cable gland	25		
N			
Name of station			
Display	115		
Nameplate	17		
NAMUR signals, description	61		
NE107			
Display color	56		
Status signals	61		
Network Information	115		
Notes on safety information	2		
Numbers, entering	38		
O			
O2 measurement with CIP	101		
Operating mode, select	66		
Operating point, Memosens ISFET sensor	129		
Operating states	41		
Operator level	43		
Optical oxygen sensor			
Parameter setting	97		
Sensor connection	31		
Option			
Activate	49		
Descriptions	235		
Overview	13		
Option activation	49		
Optocoupler input			
Parameter setting	65		

Optocoupler input OK1		Process variable conductivity (contacting)	
Function control	48	Calibration/Adjustment	133
Parameter set selection	47	Parameter setting	80
ORP		Wiring examples, analog sensors	210
Calibration/Adjustment	130	Process variable conductivity (dual)	
Parameter setting	76	Calculation blocks	244
Wiring example, analog sensor	208	Parameter setting	95
ORP adjustment	131	Wiring examples	219
ORP check	132	Process variable conductivity (inductive)	
ORP process variable		Calibration/Adjustment	139
Parameter setting	76	Parameter setting	87
Wiring example, analog sensor	208	Wiring examples, analog sensors	217
Out of specification		Process variable ORP	
Signaling via relay contact	61	Calibration/Adjustment	130
Output current		Process variable oxygen	
Current characteristic (FW-E006)	237	Calibration/Adjustment	146
Manual entry	160	Parameter setting	96
Output filter	60	Wiring examples, analog sensors	222
Output filter time interval	60	Process variable pH	
Oxygen		Buffer tables	225
Calibration/Adjustment	146	Calibration/Adjustment	122
Parameter setting	96	Individual buffer set (FW-E002)	235
Wiring examples, analog sensors	222	Parameter setting	67
		Wiring examples, analog sensors	202
P		Product calibration	
Package contents	16	PROFINET	111
Panel mounting ZU0738	24	Product calibration/adjustment	
Parameter sets	47	Cond	136
Parameter sets 1-5 (FW-E102)	249	Condl	142
Parameter setting		Oxygen	149
Cond	80	pH	127
Condl	87	Product Line	13
General	51	Product range	12
Open	43	PROFINET	104
ORP	76	Available measured values	109
Overview of menus	45	No connection	162
Oxygen	96	Relay Contacts	64
pH	67	Specifications	192
Passcodes		System Integration	104
Change/deactivate	50	PROFINET commands	111
Factory setting	50	PROFINET diagnostic information	117
Personnel requirements	10	PROFINET diagnostics	115
Pfautler sensors (FW-E017)		PROFINET monitor	116
Description	242	PROFINET technology	253
Parameter setting	69	Property damage	9
Wiring example	207	Protective hood ZU0737	23
pH			
Buffer tables	225	Q	
Calibration/Adjustment	122	Qualified personnel	10
Individual buffer set (FW-E002)	235		
Parameter setting	67	R	
Wiring examples, analog sensors	202	Reduction sealing insert for cable gland	25
pH value calculation by means of dual conductivity measurement	246	Relay contacts	
Pipe mounting ZU0274	22	Functional test	160
Power Out		Hysteresis	62
Parameter setting	66	Parameter setting	60
Terminal assignments	31	Protective wiring	29
Presettings for calibration		Usage: Failure	61
Cond parameter setting	84	Usage: Function check	62
Condl parameter setting	91	Usage: Limit	62
ORP parameter setting	78	Usage: Maintenance required	61
Oxy parameter setting	102	Usage: Out of specification	61
pH parameter setting	73	Usage: Rinse contact	63
Pressure correction	102	Usage: Sensoface	64

Usage: USP output	64
Usage:DO 1 / DO 2	64
Relay test	160
Rescue TAN	50
Reset to default	50
PROFINET	107
Restore factory settings	50
PROFINET	107
Returns	181
Ring topology	253
Rinse function, parameter setting	63
RJ45 pin assignment	29
RJ45 socket ZU1072	185
RJ45 wiring	29

S

Safety chapter	9
Safety instructions	2
Salinity correction	103
Save device settings	46
Sensocheck	180
Sensoface	
Criteria	179
Description	178
Relay contact	64
Sensor connection	
Inserting the module	32
Memosens/SE740	31
Second Memosens sensor	33
Sensor data	
Cond parameter setting	81
Condl parameter setting	89
Oxy parameter setting	99
pH parameter setting	70
Sensor diagram	156
Sensor information, digital sensors	156
Sensor monitor	
During function check	159
During operation	156
Sensor monitoring, adjusting	71, 77, 82, 90, 100
Sensor polarization	
Parameter setting	98
Sensor selection	66
Sensor wear monitor	157
SIP counter	
Cond parameter setting	83
Condl parameter setting	90
Oxy parameter setting	100
pH parameter setting	71
Slope	
Oxygen measurement	146
Softkeys	
Display	36
Function control	48
Keypad	38
Specifications	189
Standard gateway	
Display	115
Star topology	253
Statistics	157
Subnet mask	
Display	115
Supplemental directives	2
Symbols and markings	
Display	39

System control	45
System Integration	104
System overview	
Inputs and outputs	15

T

TAN option	
Activate	49
Descriptions	235
Overview	13
TAN option FW-E002 pH buffer table	235
TAN option FW-E006 Current characteristic	237
TAN option FW-E009 Concentration determination	237
TAN option FW-E015 Trace oxygen measurement	
Calibration/Adjustment	151
Wiring example	223
TAN option FW-E017 "Pfaudler sensors"	
Description	242
Wiring example	207
TAN option FW-E020 Calculation blocks	244
TAN option FW-E053 ISM sensors	
Description	248
Oxygen wiring example	224
pH wiring example	209
TAN option FW-E102 Parameter sets 1-5	249
TAN option FW-E103 Measurement recorder	
Delete data	49
Description	250
Display data	250
TAN option FW-E104 Logbook	154
TAN option FW-E106 Firmware update	252
TDS function	85, 92
Temp. offset log	156
Temperature compensation of process medium	
Cond parameter setting	84, 92
pH parameter setting	74
Temperature probe, adjustment	129, 132, 138, 145, 151
Terminal assignments	27
Terminals	27
Time/date	48
Topology	253
Trace impurities in ultrapure water	84, 92
Trace oxygen measurement (FW-E015)	
Calibration/Adjustment	151
Wiring example	223
Transfer configuration	46
Trilinear curve	59
Troubleshooting	161
Typical applications	
pH value calculation by means of dual conductivity measurement	246

U

Ultrapure water with trace impurities	84, 92
Units/formats, parameter setting	51
User interface	36
USP function	
Display values	85, 93
Parameter setting	85, 93
Relay contact	64

V

Viewing level	43
---------------	----

W

Wall mounting	20
Warnings	2
Wiring examples	
Conductivity (contacting)	210
Conductivity (dual)	219
Conductivity (inductive)	217
ORP analog	208
Oxygen, analog	222
pH analog	202

Y

Y cable M12 A type/D type ZU1164	187
----------------------------------	-----

Z

Zero correction	
Condl	144
Oxygen	151
ZU1072 RJ45 socket	185
ZU1073 adapter cable RJ45/M12 D-type	186
ZU1164 Y cable M12 A type/D type	187
ZU1166 adapter cable RJ45/M12 A type	188



Knick
Elektronische Messgeräte
GmbH & Co. KG

Headquarters

Beuckestraße 22 • 14163 Berlin
Germany
Phone: +49 30 80191-0
Fax: +49 30 80191-200
info@knick.de
www.knick.de

Local Contacts

www.knick-international.com

Translation of the original instructions
Copyright 2022 • Subject to change
Version 2 • This document was published on December 20, 2022.
The latest documents are available for download on our
website under the corresponding product description.

TA-212.514-KNEN02



100870