

User Manual

P41000 High Voltage Transducer

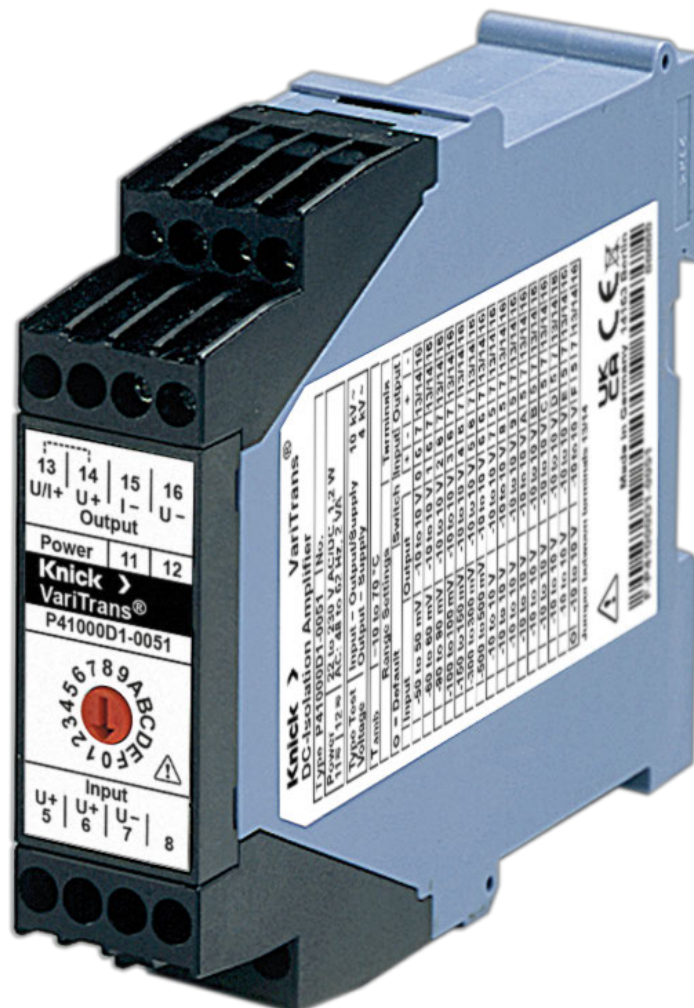

Read before installation.
Keep for future use.



Supplemental Directives

READ AND SAVE THIS DOCUMENT FOR FUTURE REFERENCE. BEFORE ATTEMPTING TO ASSEMBLE, INSTALL, OPERATE OR MAINTAIN THE PRODUCT, PLEASE ENSURE A COMPLETE UNDERSTANDING OF THE INSTRUCTIONS AND RISKS DESCRIBED HEREIN. ALWAYS OBSERVE ALL SAFETY INFORMATION. FAILURE TO COMPLY WITH INSTRUCTIONS IN THIS DOCUMENT COULD RESULT IN SERIOUS INJURY AND/OR PROPERTY DAMAGE. THIS DOCUMENT IS SUBJECT TO CHANGE WITHOUT NOTICE.

These supplemental directives explain how safety information is laid out in this document and what content it covers.

Safety Chapter

This document's safety chapter is designed to give the reader a basic understanding of safety. It illustrates general hazards and gives strategies on how to avoid them.

Warnings

This document uses the following warnings to indicate hazardous situations:



Symbol	Category	Meaning	Remark
	WARNING	Designates a situation that can lead to death or serious (irreversible) injury.	The warnings contain information on how to avoid the hazard.
	CAUTION	Designates a situation that can lead to slight or moderate (reversible) injury.	
<i>None</i>	NOTICE	Designates a situation that can lead to property or environmental damage.	

Table of Contents

1 Safety	4
1.1 Intended Use	4
1.2 Personnel Requirements	4
1.3 Isolation	4
2 Product	5
2.1 Package Contents	5
2.2 Product Identification.....	6
2.3 P41000D1 Basic Type Ranges	7
2.4 Nameplates	8
2.5 Symbols and Markings.....	9
2.6 Function	9
2.6.1 Functional Description	9
2.6.2 Block Diagram	9
2.6.3 Application Example	10
2.7 Terminal Assignments	10
2.8 Installation and Commissioning.....	11
2.9 Operation.....	12
2.10 Maintenance	12
2.11 Troubleshooting	12
2.12 Decommissioning.....	13
2.12.1 Removal	13
2.12.2 Return	13
2.12.3 Disposal.....	13
2.13 Dimension Drawings	14
2.14 Specifications	15
Abbreviations	19
Index	20

1 Safety

This document contains important instructions for the use of the product. Always follow all instructions and operate the product with caution. If you have any questions, please contact Knick Elektronische Messgeräte GmbH & Co. KG (sometimes hereafter referred to as “Knick”) using the information provided on the back page of this document.

1.1 Intended Use

The P41000 is a high voltage transducer for measuring unipolar or bipolar input voltages in the range of 0 ... (\pm)50 mV¹⁾ to 0 ... (\pm)100 V. → *Application Example, p. 10*

The input is galvanically isolated from the output and auxiliary power. The input signal is converted into a standardized analog output signal (\pm)20 mA, (\pm)10 V, or 4 ... 20 mA.

The P41000 is available in different versions:

- Versions with up to 16 calibrated and switchable input and output ranges. The input and output ranges are switched via an isolated rotary switch and the corresponding connection of the outputs. → *Terminal Assignments, p. 10*
- Versions that are permanently set to an input and output range (without rotary switch).

The specific version of the product is stated on the nameplates attached to the product. Different properties for special versions are indicated on the nameplates. The information on the nameplates is binding.

The defined operating conditions must be observed when using this product. → *Specifications, p. 15*

USE CAUTION AT ALL TIMES WHEN INSTALLING, USING, OR OTHERWISE INTERACTING WITH THE PRODUCT. ANY USE OF THE PRODUCT EXCEPT AS SET FORTH HEREIN IS PROHIBITED, AND MAY RESULT IN SERIOUS INJURY OR DEATH, AS WELL AS DAMAGE TO PROPERTY. THE OPERATING COMPANY SHALL BE SOLELY RESPONSIBLE FOR ANY DAMAGES RESULTING FROM OR ARISING OUT OF AN UNINTENDED USE OF THE PRODUCT.

Comply with the information on proper storage. → *Specifications, p. 15*

See also

→ *Product Identification, p. 6*

→ *Nameplates, p. 8*

1.2 Personnel Requirements

The operating company shall ensure that any personnel using or otherwise interacting with the product is adequately trained and has been properly instructed.

The operating company shall comply and cause its personnel to comply with all applicable laws, regulations, codes, ordinances and relevant industry qualification standards related to product. Failure to comply with the foregoing shall constitute a violation of operating company's obligations concerning the product, including but not limited to an unintended use as described in this document.

1.3 Isolation

Distances to slave devices and conductive parts in the vicinity of the device must be measured according to the applied standard. The operating company must carry out, evaluate, and safeguard isolation coordination with the clearance and creepage distances and the relevant standards (e.g., EN 50124-1).

See also

→ *Insulation, p. 17*

¹⁾ Minimum (\pm)30 mV input voltage on request

2 Product

2.1 Package Contents

- P41000 in the version ordered
- Insertable jumper, as applicable¹⁾
- Test Report 2.2 according to EN 10204
- Installation Guide with safety instructions

Note: The User Manual (this document) is published in electronic form. → knick.de

¹⁾ Dependent on the ordered version → *Product Identification*, p. 6

2.2 Product Identification

The different versions of the P41000 are encoded in a model designation.

The model designation can be found on the nameplate and the delivery note. → *Nameplates, p. 8*

Input	Output	Model Designation Working Voltage ≤ 2.2 kV AC/DC Test Voltage 10 kV AC	Model Designation Working Voltage ≤ 3.6 kV AC/DC Test Voltage 15 kV AC
±60 mV, ±90 mV, ±150 mV, ±300 mV, ±500 mV, ±10 V, bipolar Calibrated switching	±20 mA, ±10 V, bipolar, and 4... 20 mA Calibrated switching	P41000D1	–
±60 mV	±20 mA	P41056D1	P41156D1
±60 mV	4... 20 mA	P41059D1	P41159D1
0... 60 mV	4... 20 mA	P41057D1	P41157D1
±60 mV	±10 V	P41058D1	P41158D1
±90 mV	±20 mA	P41046D1	P41146D1
±90 mV	4... 20 mA	P41049D1	P41149D1
0... 90 mV	4... 20 mA	P41047D1	P41147D1
±90 mV	±10 V	P41048D1	P41148D1
±150 mV	±20 mA	P41066D1	P41166D1
±150 mV	4... 20 mA	P41069D1	P41169D1
0... 150 mV	4... 20 mA	P41067D1	P41167D1
±150 mV	±10 V	P41068D1	P41168D1
±300 mV	±20 mA	P41076D1	P41176D1
±300 mV	4... 20 mA	P41079D1	P41179D1
0... 300 mV	4... 20 mA	P41077D1	P41177D1
±300 mV	±10 V	P41078D1	P41178D1
±500 mV	±20 mA	P41086D1	P41186D1
±500 mV	4... 20 mA	P41089D1	P41189D1
0... 500 mV	4... 20 mA	P41087D1	P41187D1
±500 mV	±10 V	P41088D1	P41188D1
±1 V	±20 mA	P41096D1	P41196D1
±1 V	4... 20 mA	P41099D1	P41199D1
0... 1 V	4... 20 mA	P41097D1	P41197D1
±1 V	±10 V	P41098D1	P41198D1
±10 V	±20 mA	P41036D1	P41136D1
±10 V	±10 V	P41038D1	P41138D1
0... (±)50 mV ¹⁾ to 0... (±)100 V, unipolar/bipolar 1 to 16 ranges to customer requirements, calibrated switching	(±)20 mA, (±)10 V, unipolar/ bipolar, and/or 4... 20 mA To customer requirements, calibrated switching	P41000D1-nnnn	–
0... (±)50 mV ¹⁾ to 0... (±)100 V, unipolar/bipolar To customer requirements, fixed setting	(±)20 mA, (±)10 V, unipolar/ bipolar, or 4... 20 mA To customer requirements, fixed setting	P41000D1-nnnn	P41100D1-nnnn

¹⁾ Minimum (±)30 mV input voltage on request

2.3 P41000D1 Basic Type Ranges

Input	Terminal		Output	Terminal		Rotary Encoder Switch Position
	+	-		+	-	
-60... 60 mV	6	7	-20... 20 mA	13	15	0
-90... 90 mV	6	7	-20... 20 mA	13	15	1
-150... 150 mV	6	7	-20... 20 mA	13	15	2
-300... 300 mV	6	7	-20... 20 mA	13	15	3
-500... 500 mV	6	7	-20... 20 mA	13	15	4
-60... 60 mV	6	7	4... 20 mA	13	15	5
-90... 90 mV	6	7	4... 20 mA	13	15	6
-150... 150 mV	6	7	4... 20 mA	13	15	7
-300... 300 mV	6	7	4... 20 mA	13	15	8
-500... 500 mV	6	7	4... 20 mA	13	15	9
-60... 60 mV	6	7	-10... 10 V	13 and 14	16	A
-90... 90 mV	6	7	-10... 10 V	13 and 14	16	B
-150... 150 mV	6	7	-10... 10 V	13 and 14	16	C
-300... 300 mV	6	7	-10... 10 V	13 and 14	16	D
-500... 500 mV	6	7	-10... 10 V	13 and 14	16	E
-10... 10 V	5	7	-10... 10 V	13 and 14	16	F

Factory Setting

- Input: -10... 10 V
- Output: -10... 10 V
- Rotary encoder switch Position F

Note: The insertable jumper must be installed in terminals 13 and 14 for voltage output. No insertable jumper must be installed for current output. → *Installation and Commissioning, p. 11*

See also

→ *Nameplates, p. 8*

→ *Terminal Assignments, p. 10*

2.4 Nameplates

The P41000 is identified by nameplates on the side and front of its housing. The information on the nameplates varies depending on the version of the product.

→ *Product Identification, p. 6*

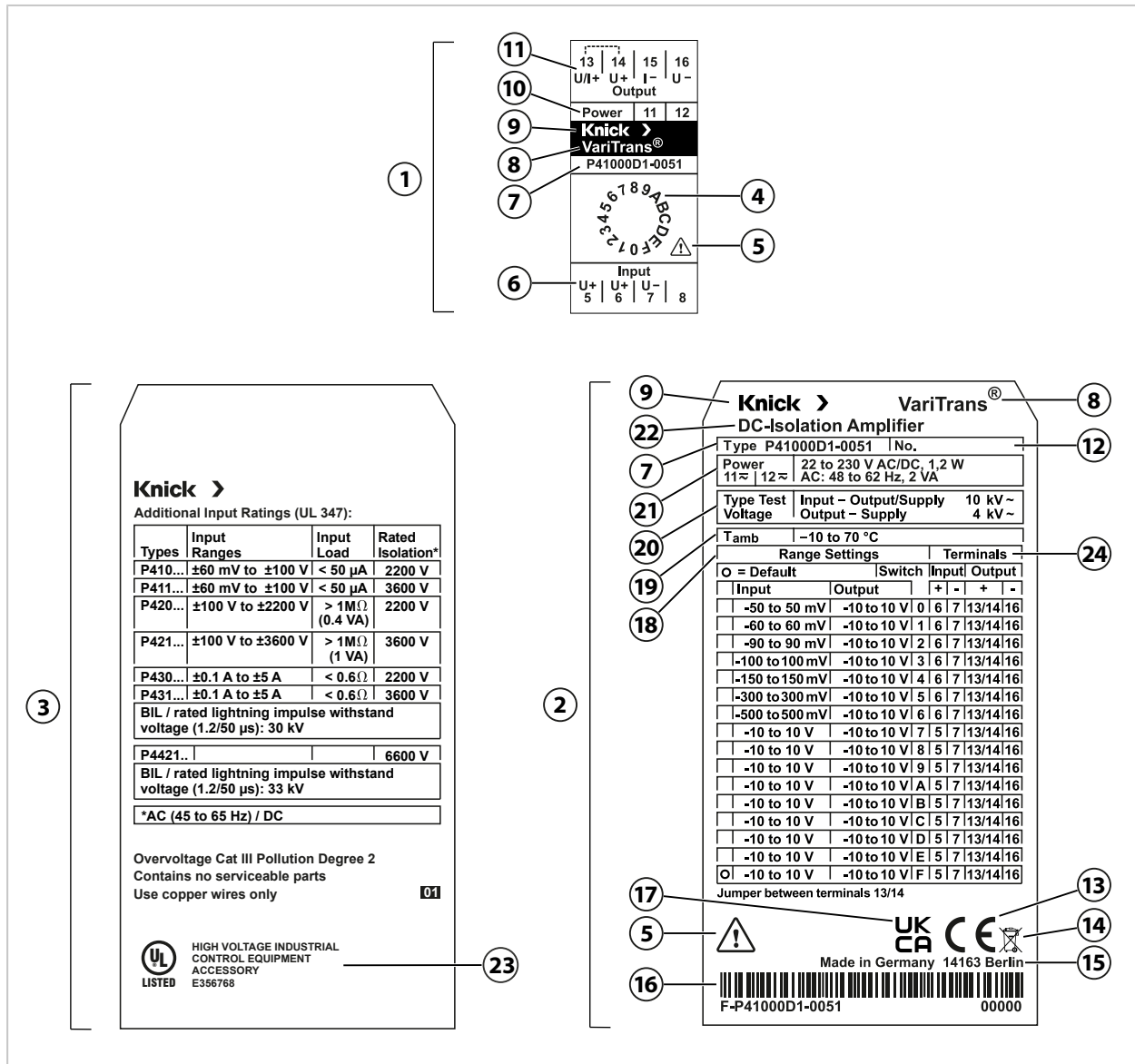

1	Nameplate, device front	13	CE mark
2	Nameplate, right side	14	WEEE mark
3	UL nameplate, left side	15	Manufacturer's address with designation of origin
4	Rotary encoder switch position marking	16	Barcode: product number, serial number, check digit
5	Special conditions and danger points	17	UKCA mark
6	Input terminal assignments	18	Input and output ranges
7	Model designation	19	Permissible ambient temperature
8	Product line	20	Type test voltage
9	Manufacturer	21	Power supply ¹⁾
10	Power supply terminal assignments	22	Product name
11	Output terminal assignments	23	UL mark with identification number
12	Product number, serial number	24	Terminal assignments

¹⁾ The device is supplied with power from a broad-range power supply (DC or AC). → *Power Supply, p. 16*

2.5 Symbols and Markings



Special conditions and danger points! Observe the safety information and instructions on safe use of the product as outlined in the product documentation.



CE marking.



UK Conformity Assessed: Conformity mark for the United Kingdom (England, Scotland, and Wales)



UL Certification Mark



The symbol on Knick products means that the waste devices must be disposed of separately from unsorted municipal waste.

2.6 Function

2.6.1 Functional Description

The P41000 is available in different versions. The product properties vary depending on the version.

→ *Product Identification, p. 6*

The unipolar or bipolar input signal is detected by the P41000 and converted into a standardized analog output signal. → *Block Diagram, p. 9*

An example application is measuring current via a shunt resistor. → *Application Example, p. 10*

The high potential of the input circuit is isolated by 3-port isolation between input, output, and power supply. → *Insulation, p. 17*

The electronic components of the P41000 are protected from environmental influences, shock, and vibration by vacuum encapsulation. → *Standards and Approvals, p. 18*

The power supply to operate the P41000 is provided by an integrated broad-range power supply.

→ *Power Supply, p. 16*

See also

→ *Intended Use, p. 4*

→ *Specifications, p. 15*

2.6.2 Block Diagram

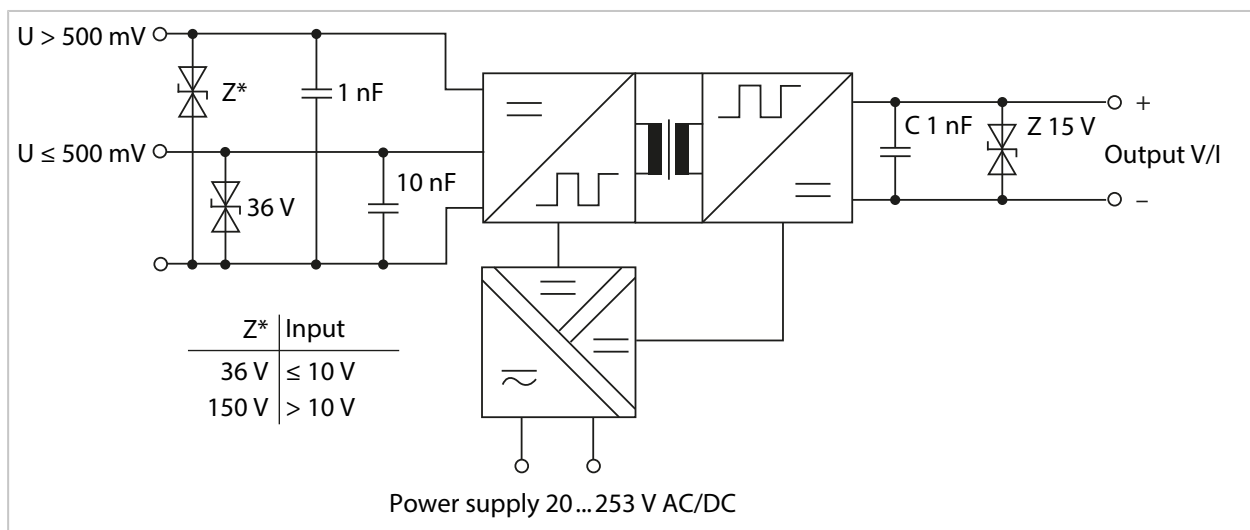

2.6.3 Application Example

Note: The figure shows an example of current measurement via a shunt resistor. The specified values refer to the P41159D1 version.

Note: In the figure, *Control* is used as an umbrella term for any form of further processing of the output signal.

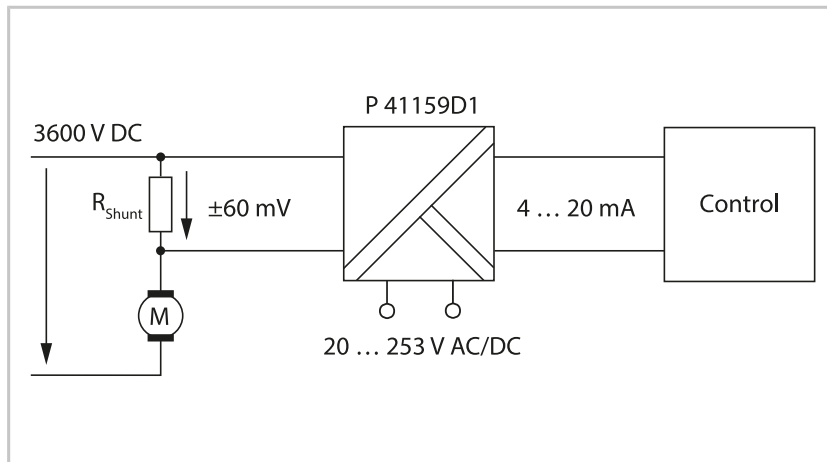

See also

→ *Product Identification, p. 6*

2.7 Terminal Assignments

Note: The insertable jumper must be installed in terminals 13 and 14 for voltage output. No insertable jumper must be installed for current output. → *Installation and Commissioning, p. 11*

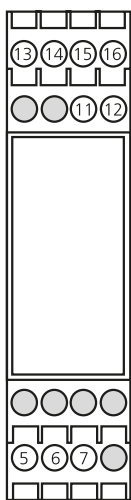

5	Input	Voltage > 500 mV... 100 V	(+)
6	Input	Voltage 50... 500 mV ¹⁾	(+)
7	Input	Voltage	(-)
11	Power supply	AC/DC	
12	Power supply	AC/DC	
13	Output	Current/voltage	(+)
14	Output	Voltage	(+)
15	Output	Current	(-)
16	Output	Voltage	(-)

See also

→ *Nameplates, p. 8*

¹⁾ Minimum (±)30 mV input voltage on request

2.8 Installation and Commissioning

⚠ WARNING! Shock potential. Do not install the product live.

NOTICE! Product damage due to electrostatic discharge (ESD). Take protective measures against electrostatic discharge.

NOTICE! Damage to the screw terminals due to excessive tightening torque. Tighten the screw terminals with a max. torque of 0.8 Nm.

Note: P41000 may only be operated in a (lockable) control cabinet.

01. Disconnect the electrical system from live parts.
02. Secure the electrical system against restart.
03. Verify that the electrical system is dead.
04. Ground and short-circuit the electrical system.
05. Cover or isolate adjacent live parts with insulating materials.
06. For switchable versions: Position the rotary switch.

Note: The available input and output ranges, and the factory settings, are indicated on the nameplate on the side.
07. For current output: As necessary, remove the pre-installed insertable jumper.

→ *Terminal Assignments, p. 10*

Note: Switchable versions are delivered from the factory with an installed insertable jumper (= voltage output). When switching to current output, the installed insertable jumper must be removed. Fixed-range versions are delivered with an installed insertable jumper for voltage output and without an insertable jumper for current output.
08. Snap the P41000 on to the 35 mm DIN rail.
09. Strip 8 mm of insulation from the cable ends, fit ferrules to the stranded wires. Twist pairs of cables to a point close to the connection.

Maximum cable cross-section	1 x 2.5 mm ² stranded wire with ferrule
	1 x 4 mm ² solid
	2 x 1.5 mm ² stranded wire with ferrule
	2 x 2.5 mm ² solid
Minimum cable cross-section	1 x 0.5 mm ² solid or stranded wire with ferrule

10. Connect the cables for the output.
11. Connect the power supply cables.

Note: The polarity of the auxiliary power can be freely selected during connection.
12. Connect the cables for the input.
13. Reset the electrical system to its initial state. Reverse the steps taken to ensure voltage-free operation.
14. Switch on the power supply.

Note: The power supply to operate the P41000 is provided by an integrated broad-range power supply (20 ... 253 V AC/DC).

See also

→ *Nameplates, p. 8*

→ *Terminal Assignments, p. 10*

→ *Troubleshooting, p. 12*

2.9 Operation

The P41000 is designed for continuous operation. The product must be operated inside a lockable control cabinet.

The defined operating conditions must be observed when using this product. → *Specifications, p. 15*

Note: With switchable versions, do not switch the input and output ranges using the rotary encoder switch during operation. → *Installation and Commissioning, p. 11*

See also

→ *Product Identification, p. 6*

→ *Nameplates, p. 8*

2.10 Maintenance

The P41000 does not require any maintenance. Because it is fully encapsulated, it is not possible to repair the product.

2.11 Troubleshooting

USE CAUTION WHEN CONDUCTING ANY TROUBLESHOOTING. FAILURE TO ABIDE BY THE REQUIREMENTS SET FORTH HEREIN MAY RESULT IN SERIOUS INJURY OR DEATH, AS WELL AS DAMAGE TO PROPERTY.

Malfunction State	Possible Causes	Remedy
Wrong signal at output	Inputs/outputs not correctly connected, e.g., polarity reversed.	Connect inputs/outputs as specified on the nameplate.
	Selectable versions: Rotary switch not correctly positioned.	Position the rotary switch as specified on the nameplate.
	Selectable versions: For voltage output, insertable jumper not present or not correctly mounted.	Position the insertable jumper as specified on the nameplate.
No output current	P41000 is not connected to the power supply.	Check the installation and switch on the power supply.

Further troubleshooting support can be obtained from → support@knick.de.

See also

→ *Terminal Assignments, p. 10*

→ *Installation and Commissioning, p. 11*

2.12 Decommissioning

2.12.1 Removal

⚠ WARNING! Shock potential. Do not uninstall the product live.

01. Disconnect the electrical system from live parts.
02. Secure the electrical system against restart.
03. Verify that the electrical system is dead.
04. Ground and short-circuit the electrical system.
05. Cover or isolate adjacent live parts with insulating materials.
06. Check the input of the P41000 to ensure it is dead.
07. Switch off the power supply.
08. Open the screw terminals with a screwdriver and remove the cables.
09. Pull down the housing's base latch using a screwdriver. Lift the P41000 up and off the 35 mm DIN rail.

2.12.2 Return

If required, send the product in a clean condition and securely packed to your local contact.

→ knick.de

2.12.3 Disposal

Local codes and regulations must be observed when disposing of the product.

Customers can return their waste electrical and electronic devices.

Details on the return and environmentally friendly disposal of electrical and electronic equipment can be found in the manufacturer's declaration on our website. If you have any queries, suggestions, or questions regarding the recycling of waste electrical and electronic equipment from Knick, please send an email to → support@knick.de

2.13 Dimension Drawings

Note: All dimensions are given in millimeters [inches].

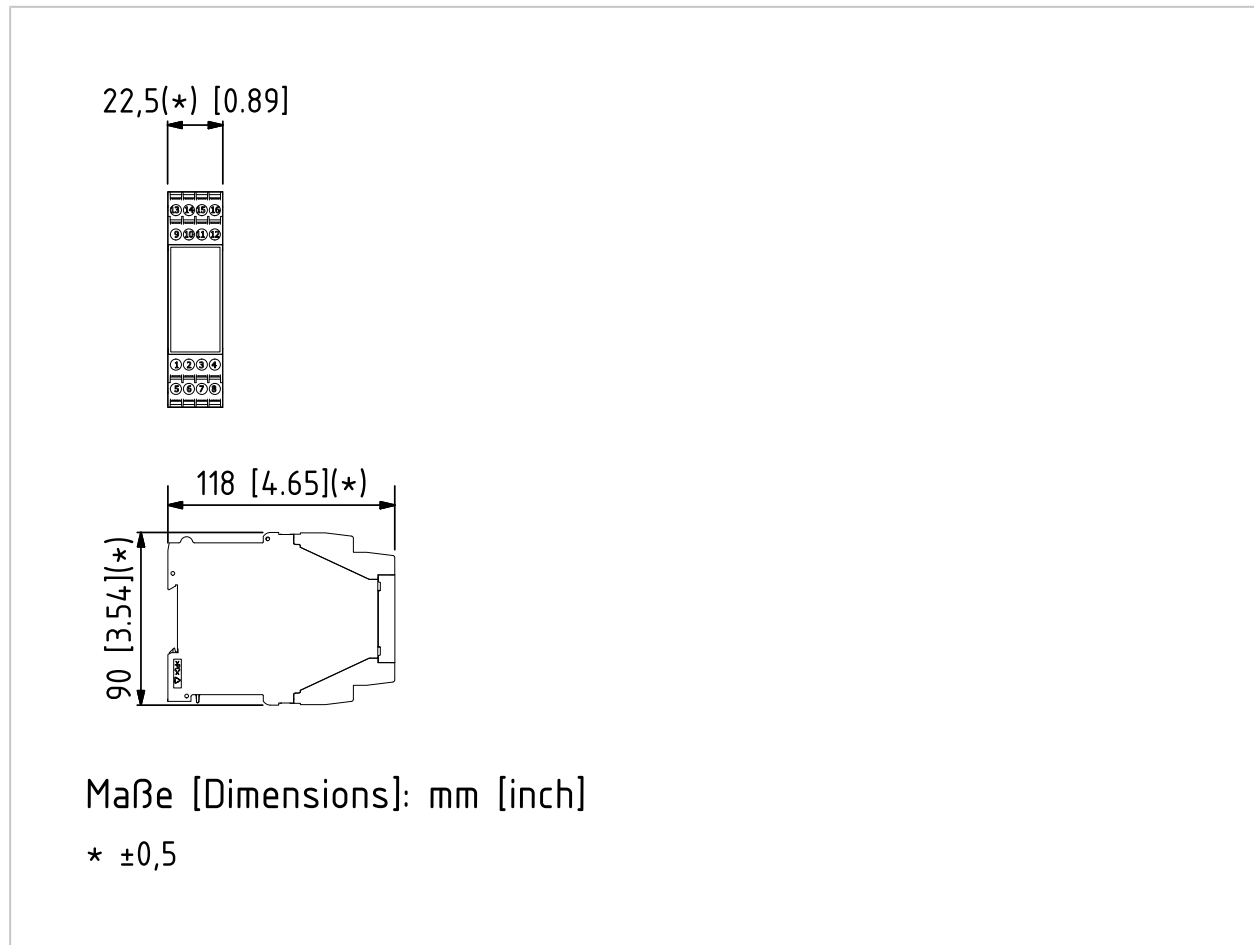

2.14 Specifications

Input

Input ¹⁾	P41000D1	± 60 mV, ± 90 mV, ± 150 mV, ± 300 mV, ± 500 mV, ± 10 V, bipolar Calibrated switching Factory setting: ± 10 V
	P41000D1-nnnn	0 ... (\pm)50 mV ²⁾ to 0 ... (\pm)100 V, unipolar/bipolar 1 to 16 ranges to customer requirements, calibrated switching
	P41100D1-nnnn	0 ... (\pm)50 mV ²⁾ to 0 ... (\pm)100 V, unipolar/bipolar To customer requirements, fixed setting
Input resistance	Range ≤ 0.5 V	Approx. 100 k Ω
	Range > 0.5 V	> 2 M Ω
Input capacitance	Range ≤ 0.5 V	Approx. 10 nF (approx. 94 nF with shunt monitoring option)
	Range > 0.5 V	Approx. 1 nF
Overload capacity	Range ≤ 10 V	Limited by 36 V suppressor diode Max. permissible continuous current = 20 mA
	Range > 10 V	Limited by 150 V suppressor diode Max. permissible continuous current = 3 mA

Output

Output	P41000D1	± 20 mA, ± 10 V, bipolar, and 4 ... 20 mA Calibrated switching Factory setting: ± 10 V
	P41000D1-nnnn	(\pm)20 mA, (\pm)10 V, unipolar/bipolar, and/or 4 ... 20 mA To customer requirements, calibrated switching
	P41100D1-nnnn	(\pm)20 mA, (\pm)10 V, unipolar/bipolar, or 4 ... 20 mA To customer requirements, fixed setting
Offset	Up to ± 150 % by default	
Load	With output current:	≤ 12 V (600 Ω at 20 mA)
	With output voltage:	≤ 10 mA (1000 Ω at 10 V)
Offset error	< 20 μ A or 10 mV	
Ripple	< 10 mV _{rms}	

¹⁾ Up to 500 mV input voltage with shunt monitoring on request

²⁾ Minimum (\pm)30 mV input voltage on request

Transmission Behavior

Gain error	< 0.1 % of measured value		
Cutoff frequency (-3 dB)	Approx. 5 kHz Optional factory setting: 10 Hz		
Response time T_{90}	Approx. 110 μ s		
Common-mode rejection ratio	Input ranges ≤ 1 V	CMRR ¹⁾	Approx. 150 dB (DC/AC: 50 Hz)
		T-CMRR ²⁾	Approx. 115 dB (1000 V, $t_r = 1 \mu$ s)
	Input ranges > 1 V	CMRR ¹⁾	DC: approx. 150 dB AC 50 Hz: approx. 120 dB
Temperature coefficient ³⁾	< 0.005 %/K full scale		

Power Supply

Power supply	22 ... 230 V AC, ± 10 %, 48 ... 62 Hz, approx. 2 VA		
	22 ... 230 V DC, ± 10 %, approx. 1.2 W		

¹⁾ Common-mode rejection ratio = differential voltage gain / common-mode voltage gain

²⁾ Transient Common-Mode Rejection Ratio

³⁾ Reference temperature for temperature coefficient specifications = 23 °C (73.4 °F) The average temperature coefficient is stated.

Insulation

Galvanic isolation	3-port isolation between input, output, and power supply	
Test voltage	Calibrated switching	10 kV AC across input and output/power supply
	Fixed (P410**D1)	10 kV AC across input and output/power supply
	Fixed (P411**D1)	15 kV AC across input and output/power supply
	All types	4 kV AC across output and power supply
Insulation coordination:	For applications with high working voltages, take measures to prevent accidental contact and make sure that there is sufficient distance or insulation between adjacent devices.	
Working voltage (basic insulation) according to EN 61010-1	Calibrated switching or fixed (P410**D1)	Up to 2200 V AC/DC across input and output/power supply with overvoltage category III and pollution degree 2 (transient overvoltage: max. 13.5 kV)
	Fixed (P411**D1)	Up to 3600 V AC/DC across input and output/power supply with overvoltage category III and pollution degree 2 (transient overvoltage: max. 20 kV)
Rated insulation voltage according to EN 50124-1	Calibrated switching or fixed (P410**D1)	Up to 2200 V AC/DC across input and output/power supply with overvoltage category III and pollution degree 2
	Fixed (P411**D1)	Up to 3600 V AC/DC across input and output/power supply with overvoltage category III and pollution degree 2
Protection against electric shock	Calibrated switching or fixed (P410**D1)	Protective separation according to EN 61140 by reinforced insulation according to EN 61010-1. Working voltages at overvoltage category III and pollution degree 2: <ul style="list-style-type: none"> • Up to 1100 V AC/DC across input and output/power supply • Up to 300 V AC/DC across output and power supply
	Fixed (P411**D1)	Protective separation according to EN 61140 by reinforced insulation according to EN 61010-1. Working voltages at overvoltage category III and pollution degree 2: <ul style="list-style-type: none"> • Up to 1800 V AC/DC across input and output/power supply • Up to 300 V AC/DC across output and power supply
Rated voltage according to UL 347	P410**D1	2200 V AC (45 ... 65 Hz) / DC
	P411**D1	3600 V AC (45 ... 65 Hz) / DC
	Input impedance	< 50 μ A
	BIL/rated surge voltage	30 kV (1.2/50 μ s)
	Overvoltage category	OV3
	Pollution degree	PD2
	P41000 does not contain any components that require maintenance. Use copper cables only.	

Standards and Approvals

EMC ¹⁾	Product standard	EN 61326-1
	Emitted interference	Class B
	Immunity to interference	Industrial applications
UL	Listed according to UL 347	E356768
Mechanical strength	IEC 61373	
RoHS conformity	According to Directive 2011/65/EU	

Device

MTBF ²⁾	Approx. 96 years	
Ambient temperature	Operating ³⁾	-10 ... 70 °C (14 ... 158 °F)
	Transport and storage	-40 ... 85 °C (-40 ... 185 °F)
Ambient conditions	Indoor use ⁴⁾	
	Relative humidity 5 ... 95 %, no condensation	
	Altitude up to 2000 m (6500 ft), air pressure: 790 ... 1060 hPa ⁵⁾	
Design	Modular housing with screw terminals (max. tightening torque 0.8 Nm)	
	Housing width	P41***D1 22.5 mm
	Other dimensions → <i>Dimension Drawings</i> , p. 14	
Connection	M3.5 connecting screws with self-lifting terminal clamps	
	Maximum cable cross-section	1 x 2.5 mm ² stranded wire with ferrule
		1 x 4 mm ² solid
		2 x 1.5 mm ² stranded wire with ferrule
		2 x 2.5 mm ² solid
Minimum cable cross-section	1 x 0.5 mm ² solid or stranded wire with ferrule	
Degree of protection	Housing IP40, terminals IP20	
Mounting	35 mm DIN rail for snap-on mounting according to EN 60715	
Weight	Approx. 180 g	

¹⁾ Slight deviations are possible during interference.

²⁾ Mean time between failures (MTBF) according to EN 61709 (SN 29500). Requirements: stationary operation in well-kept spaces, average ambient temperature 40 °C, no aeration, continuous operation.

³⁾ Extended operating temperature range -40 ... 75 °C (-40 ... 167 °F), short-time 85 °C (185 °F) on request

⁴⁾ In enclosed areas, protected from the weather; not permissible are: water or wind-driven precipitation (rain, snow, hail etc.)

⁵⁾ At low air pressure, the permissible working voltages are reduced.

Abbreviations

BIL	Basic impulse level (rated insulation voltage according to UL 347)
CE	Conformité Européenne (European conformity)
EMC	Electromagnetic compatibility
EN	European standard
ESD	Electrostatic discharge
IP	International Protection / Ingress Protection
MTBF	Mean time between failures
OV	Overvoltage category
PD	Pollution degree
UKCA	United Kingdom Conformity Assessed
UL	Underwriter Laboratories (recognized testing and certification organization)
WEEE	Waste from electrical and electronic equipment

Index

35 mm DIN rail 18

A

Application example 10
Approvals 18

B

Base latch 13
Basic type 7

C

Causes, malfunctions 12
Conformity 18

D

Dimension drawing 14
DIN rail 18
Disposal 13

E

Electrical installation 11
Electromagnetic compatibility 18
Electrostatic discharge 11
Environmental damage 4
Error elimination 12

F

Factory setting 11

G

Galvanic isolation 17

I

Input 15
Insertable jumper 11
Insulation 17
Introductory safety chapter 2

J

Jumper 11

M

M3.5 connecting screw 18
Malfunction states 12
Markings 9
Measuring ranges 7
Model designation
 Coding 6
 Versions 7
Mounting 18

N

Nameplate
 Device front 8
 Side 8
 UL 8
Notes on safety information 2

O

Order code 6
Output 15

P

Package contents 5
Personnel 4
Personnel requirements 4
Power supply 16
Product code 6
Property damage 4

Q

Qualified personnel 4

R

Range selection 11
Recycling 13
Remedies, malfunctions 12
Return of waste equipment 13
Returns 13
Rotary switch 11

S

Safety chapter 4
Safety instructions 2
Standards 18
Supplemental directives 2
Supply voltage 16
Symbols and markings 9

T

Terminal assignments 10
Terminals 10
Test voltage 17
Transmission behavior 16
Troubleshooting 12
Type designation 6
Typical application 10

V

Variants 7
Versions 6

W

Warnings 2



Knick
Elektronische Messgeräte
GmbH & Co. KG

Headquarters

Beuckestraße 22 • 14163 Berlin
Germany
Phone: +49 30 80191-0
Fax: +49 30 80191-200
info@knick.de
www.knick.de

Local Contacts

www.knick-international.com

Translation of the original instructions
Copyright 2023 • Subject to change
Version 6 • This document was published on April 20, 2023.
The latest documents are available for download on our
website under the corresponding product description.

TA-253.106-KNEN06



100436